

KARIZMA luce®

**Q-Line** series  
48V TRACK SYSTEM

“Small gestures  
**can have big impact**”

## BENEFITS AT A GLANCE.

Thanks to the design of a low voltage system, the track luminaires can be very small, compared with common 230V track systems.

This great benefit leads to extraordinary designs and follows the trends in the market of miniaturization of LED luminaires.

- Compact dimensions and timeless design
- DALI and ON/OFF
- Available track lengths: 1m, 1.5m and 2m
- Maximum distance between AC/DC converter and last luminaire: 15m with 2.5mm. wiring
- Available with 4 types of rails:
  1. recessed deep
  2. surfaced mini
  3. surfaced rail high
  4. suspension set to suspend one of the surfaced rails.

Choose a luminaire, white or black body and add your anti glare Dea Della Luce reflector to enrich your interior in unprecedented ways.

## JUST LET THE LIGHT PLAY THE MAIN ROLE.

Welcome to the world of miniature luminaires: the Q-Line Series 48V track system of Karizma Luce. We introduce a new low voltage spotlight collection, more compact than ever before. The Q-Line 48V track series excels in its versatility, efficiency and aesthetics.

## 48V: A REAL GAME CHANGER.

The very compact dimensions and timeless design, combined with a wide range of options and the effortless installation, make the Q-Line series a real game changer. These miniature luminaires can be adjusted just the way you want it, ready to make a big impact.

## PLUG, PLAY AND CREATE.

The 48V track spots are mounted in a subtle rail and are available as recessed, surface and suspended version. This special 48V rail system is perfect for areas where constant flexibility is required, such as luxury homes, shops and galleries. Thanks to the 48V low voltage you can just simply plug and play to create a vibrant lighting solution.

# CONTENT.

**8**

Dea Juno-Q1 / Q2 XS

**10**

Dea Juno-Q1 / Q2 DUO XS

**14**

Dea Juventas-Q XS

**20**

Dea Vesta-Q1 / Q2

**24**

Linea lens

**26**

Linea lens adjustable

**28**

Linea opal

**30**

48V Track Parts

**32**

Installation manual

**Q-Line series**  
48V TRACK SYSTEM

5 years  
warranty

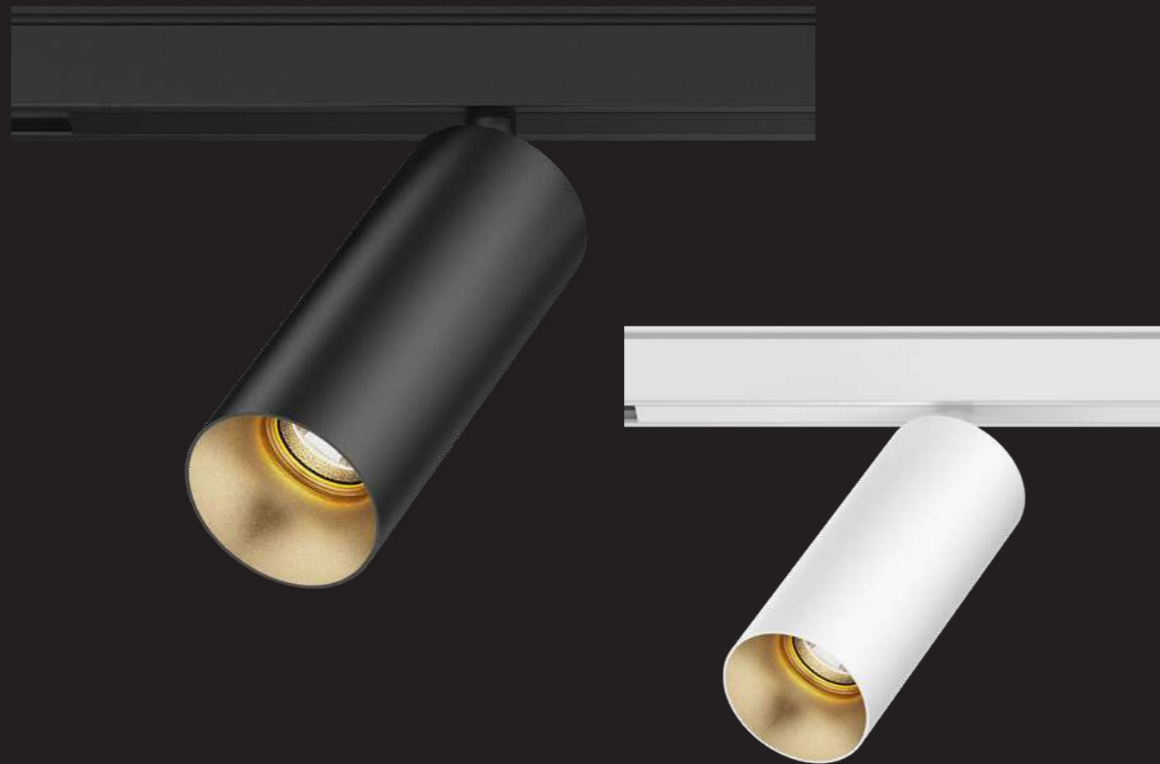

• **DEA JUNO-Q1 / Q2 XS**

The 48V luminaire Dea Juno is a real eye-catcher thanks to its small measurements, deep recessed light source and beautiful colour options. Use the Dea Juno in combination with Casambi to create a smart and balanced lighting solution. Particularly suitable for use in boutiques, hospitality and even in homes.

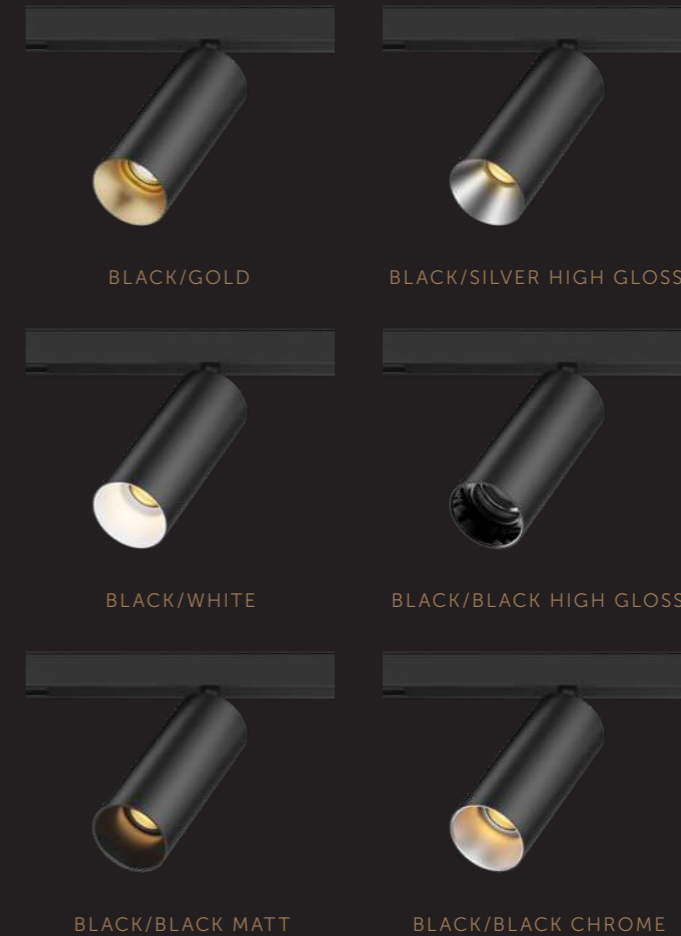

BLACK/GOLD

BLACK/SILVER HIGH GLOSS

BLACK/WHITE

BLACK/BLACK HIGH GLOSS

BLACK/BLACK MATT

BLACK/BLACK CHROME



WHITE/GOLD

WHITE/SILVER HIGH GLOSS

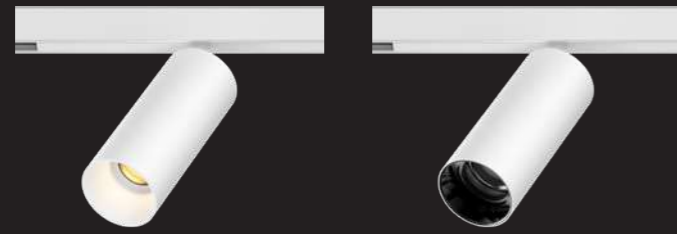

WHITE/WHITE

WHITE/BLACK HIGH GLOSS



WHITE/BLACK MATT

WHITE/CHROME

**NEW**



**COPPER REFLECTOR**

View full specs on [karizmaluce.com](http://karizmaluce.com)

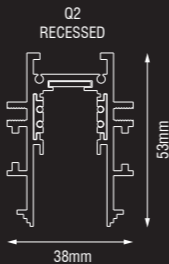
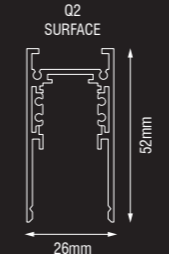
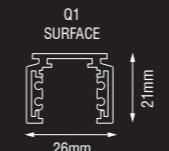

Dea Juno-Q1 XS



Description	reflector	∧	white	black
490lm 927 7W	black high gloss	34°	Q611BW92734BGF0	Q611BB92734BGF0
500lm 930 7W	black high gloss	34°	Q611BW93034BGF0	Q611BB93034BGF0
510lm 940 7W	black high gloss	34°	Q611BW94034BGF0	Q611BB94034BGF0
490lm 927 7W	silver high gloss	34°	Q611BW92734SGF0	Q611BB92734SGF0
500lm 930 7W	silver high gloss	34°	Q611BW93034SGF0	Q611BB93034SGF0
510lm 940 7W	silver high gloss	34°	Q611BW94034SGF0	Q611BB94034SGF0
490lm 927 7W	chrome	34°	Q611BW92734CHF0	Q611BB92734CHF0
500lm 930 7W	chrome	34°	Q611BW93034CHF0	Q611BB93034CHF0
510lm 940 7W	chrome	34°	Q611BW94034CHF0	Q611BB94034CHF0
490lm 927 7W	white	34°	Q611BW92734WHF0	Q611BB92734WHF0
500lm 930 7W	white	34°	Q611BW93034WHF0	Q611BB93034WHF0
510lm 940 7W	white	34°	Q611BW94034WHF0	Q611BB94034WHF0
490lm 927 7W	gold	34°	Q611BW92734GOF0	Q611BB92734GOF0
500lm 930 7W	gold	34°	Q611BW93034GOF0	Q611BB93034GOF0
510lm 940 7W	gold	34°	Q611BW94034GOF0	Q611BB94034GOF0
490lm 927 7W	black matt	34°	Q611BW92734BMF0	Q611BB92734BMF0
500lm 930 7W	black matt	34°	Q611BW93034BMF0	Q611BB93034BMF0
510lm 940 7W	black matt	34°	Q611BW94034BMF0	Q611BB94034BMF0

Dea Juno-Q2 XS



Description	reflector	∧	white	black
490lm 927 7W	black high gloss	34°	Q621BW92734BG00	Q621BB92734BG00
500lm 930 7W	black high gloss	34°	Q621BW93034BG00	Q621BB93034BG00
510lm 940 7W	black high gloss	34°	Q621BW94034BG00	Q621BB94034BG00
490lm 927 7W	silver high gloss	34°	Q621BW92734SG00	Q621BB92734SG00
500lm 930 7W	silver high gloss	34°	Q621BW93034SG00	Q621BB93034SG00
510lm 940 7W	silver high gloss	34°	Q621BW94034SG00	Q621BB94034SG00
490lm 927 7W	chrome	34°	Q621BW92734CH00	Q621BB92734CH00
500lm 930 7W	chrome	34°	Q621BW93034CH00	Q621BB93034CH00
510lm 940 7W	chrome	34°	Q621BW94034CH00	Q621BB94034CH00
490lm 927 7W	white	34°	Q621BW92734WH00	Q621BB92734WH00
500lm 930 7W	white	34°	Q621BW93034WH00	Q621BB93034WH00
510lm 940 7W	white	34°	Q621BW94034WH00	Q621BB94034WH00
490lm 927 7W	gold	34°	Q621BW92734GO00	Q621BB92734GO00
500lm 930 7W	gold	34°	Q621BW93034GO00	Q621BB93034GO00
510lm 940 7W	gold	34°	Q621BW94034GO00	Q621BB94034GO00
490lm 927 7W	black matt	34°	Q621BW92734BM00	Q621BB92734BM00
500lm 930 7W	black matt	34°	Q621BW93034BM00	Q621BB93034BM00
510lm 940 7W	black matt	34°	Q621BW94034BM00	Q621BB94034BM00

**Q-Line series**  
48V TRACK SYSTEM

5 years  
warranty

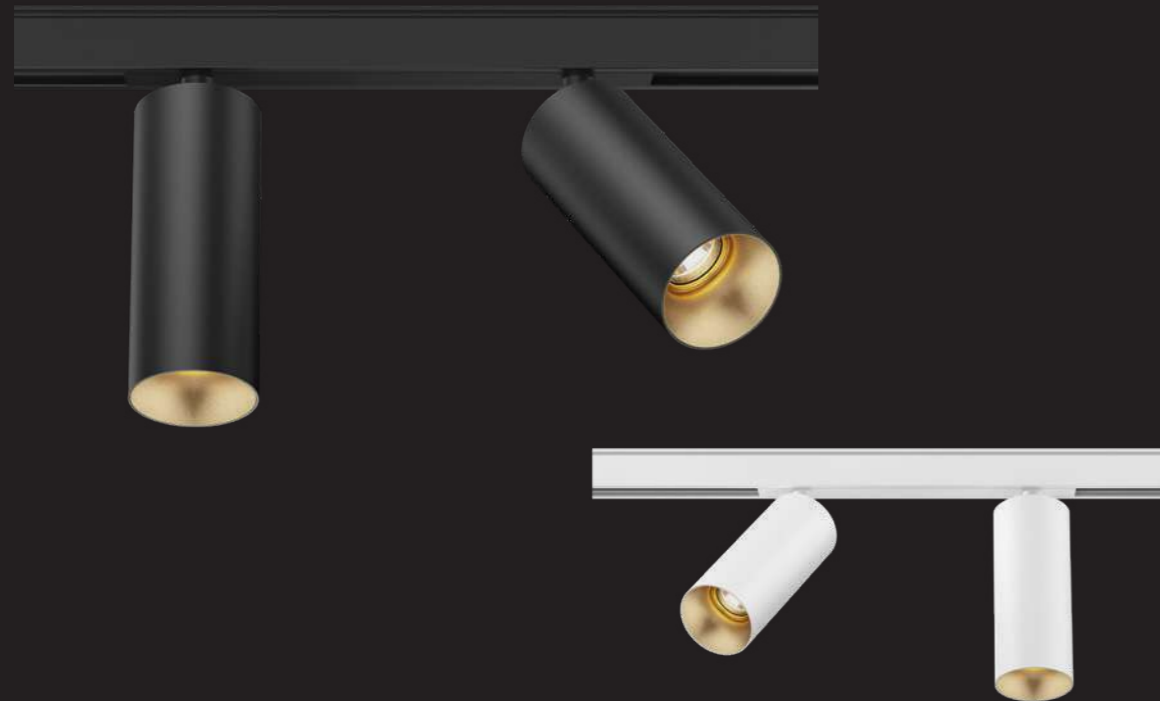

BLACK/GOLD



BLACK/SILVER HIGH GLOSS



BLACK/WHITE



BLACK/BLACK HIGH GLOSS



BLACK/BLACK MATT



BLACK/BLACK CHROME

## • DEA JUNO-Q1 / Q2 DUO XS

The 48V luminaire Dea Juno duo is a real eye-catcher thanks to its small measurements, deep recessed light source and beautiful colour options. This double 48V track spot ensures you not only a timeless design, it also offers maximum modern-day efficiency. It is perfectly suitable for spaces where frequent changes are typical, use the Dea Juno duo in combination with Casambi to create a smart and balanced lighting solution.



WHITE/GOLD



WHITE/SILVER HIGH GLOSS



WHITE/WHITE



WHITE/BLACK HIGH GLOSS



WHITE/BLACK MATT



WHITE/CHROME



View full specs on [karizmaluce.com](http://karizmaluce.com)

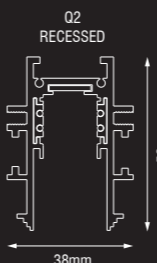
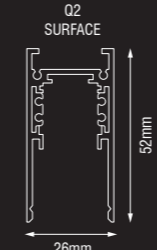
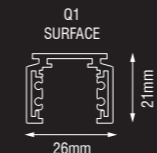

Dea Juno-Q1 DUO XS



Description	reflector	^	white	
			white	black
2x490lm 927 14W	black high gloss	34°	Q612BW92734BGF0	Q612BB92734BGF0
2x500lm 930 14W	black high gloss	34°	Q612BW93034BGF0	Q612BB93034BGF0
2x510lm 940 14W	black high gloss	34°	Q612BW94034BGF0	Q612BB94034BGF0
2x490lm 927 14W	silver high gloss	34°	Q612BW92734SGF0	Q612BB92734SGF0
2x500lm 930 14W	silver high gloss	34°	Q612BW93034SGF0	Q612BB93034SGF0
2x510lm 940 14W	silver high gloss	34°	Q612BW94034SGF0	Q612BB94034SGF0
2x490lm 927 14W	chrome	34°	Q612BW92734CHF0	Q612BB92734CHF0
2x500lm 930 14W	chrome	34°	Q612BW93034CHF0	Q612BB93034CHF0
2x510lm 940 14W	chrome	34°	Q612BW94034CHF0	Q612BB94034CHF0
2x490lm 927 14W	white	34°	Q612BW92734WHF0	Q612BB92734WHF0
2x500lm 930 14W	white	34°	Q612BW93034WHF0	Q612BB93034WHF0
2x510lm 940 14W	white	34°	Q612BW94034WHF0	Q612BB94034WHF0
2x490lm 927 14W	gold	34°	Q612BW92734GOF0	Q612BB92734GOF0
2x500lm 930 14W	gold	34°	Q612BW93034GOF0	Q612BB93034GOF0
2x510lm 940 14W	gold	34°	Q612BW94034GOF0	Q612BB94034GOF0
2x490lm 927 14W	black matt	34°	Q612BW92734BMF0	Q612BB92734BMF0
2x500lm 930 14W	black matt	34°	Q612BW93034BMF0	Q612BB93034BMF0
2x510lm 940 14W	black matt	34°	Q612BW94034BMF0	Q612BB94034BMF0

Dea Juno-Q2 DUO XS



Description	reflector	^	white	
			white	black
2x490lm 927 14W	black high gloss	34°	Q622BW92734BGF0	Q622BB92734BGF0
2x500lm 930 14W	black high gloss	34°	Q622BW93034BGF0	Q622BB93034BGF0
2x510lm 940 14W	black high gloss	34°	Q622BW94034BGF0	Q622BB94034BGF0
2x490lm 927 14W	silver high gloss	34°	Q622BW92734SGF0	Q622BB92734SGF0
2x500lm 930 14W	silver high gloss	34°	Q622BW93034SGF0	Q622BB93034SGF0
2x510lm 940 14W	silver high gloss	34°	Q622BW94034SGF0	Q622BB94034SGF0
2x490lm 927 14W	chrome	34°	Q622BW92734CHF0	Q622BB92734CHF0
2x500lm 930 14W	chrome	34°	Q622BW93034CHF0	Q622BB93034CHF0
2x510lm 940 14W	chrome	34°	Q622BW94034CHF0	Q622BB94034CHF0
2x490lm 927 14W	white	34°	Q622BW92734WHF0	Q622BB92734WHF0
2x500lm 930 14W	white	34°	Q622BW93034WHF0	Q622BB93034WHF0
2x510lm 940 14W	white	34°	Q622BW94034WHF0	Q622BB94034WHF0
2x490lm 927 14W	gold	34°	Q622BW92734GOF0	Q622BB92734GOF0
2x500lm 930 14W	gold	34°	Q622BW93034GOF0	Q622BB93034GOF0
2x510lm 940 14W	gold	34°	Q622BW94034GOF0	Q622BB94034GOF0
2x490lm 927 14W	black matt	34°	Q622BW92734BMF0	Q622BB92734BMF0
2x500lm 930 14W	black matt	34°	Q622BW93034BMF0	Q622BB93034BMF0
2x510lm 940 14W	black matt	34°	Q622BW94034BMF0	Q622BB94034BMF0

**Q-Line series**  
48V TRACK SYSTEM

5 years  
warranty



• **DEA JUVENTAS-Q XS**

Our youngest asset to the 48V family is the Dea Juventas. Small, but very talented. Especially when it comes to accuracy and efficiency. This miniature luminaire can be adjusted just the way you want it. Thanks to the 48V low voltage you can just simply plug and play and have a vibrant lighting solution for years to come.



BLACK/GOLD

BLACK/SILVER HIGH GLOSS

BLACK/WHITE

BLACK/BLACK HIGH GLOSS

BLACK/BLACK MATT

BLACK/BLACK CHROME





WHITE/GOLD



WHITE/SILVER HIGH GLOSS



WHITE/WHITE



WHITE/BLACK HIGH GLOSS



WHITE/BLACK MATT



WHITE/CHROME



View full specs on [karizmaluce.com](http://karizmaluce.com)

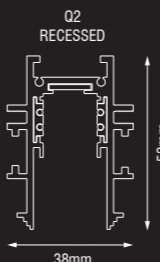
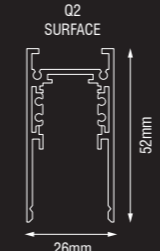
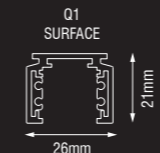

Dea Juventas-Q1 XS



Description	reflector	^	white		black	
			white	black	white	black
490lm 927 7W	black high gloss	34°	Q613BW92734BGF0	Q613BB92734BGF0		
500lm 930 7W	black high gloss	34°	Q613BW93034BGF0	Q613BB93034BGF0		
510lm 940 7W	black high gloss	34°	Q613BW94034BGF0	Q613BB94034BGF0		
490lm 927 7W	silver high gloss	34°	Q613BW92734SGF0	Q613BB92734SGF0		
500lm 930 7W	silver high gloss	34°	Q613BW93034SGF0	Q613BB93034SGF0		
510lm 940 7W	silver high gloss	34°	Q613BW94034SGF0	Q613BB94034SGF0		
490lm 927 7W	chrome	34°	Q613BW92734CHF0	Q613BB92734CHF0		
500lm 930 7W	chrome	34°	Q613BW93034CHF0	Q613BB93034CHF0		
510lm 940 7W	chrome	34°	Q613BW94034CHF0	Q613BB94034CHF0		
490lm 927 7W	white	34°	Q613BW92734WHF0	Q613BB92734WHF0		
500lm 930 7W	white	34°	Q613BW93034WHF0	Q613BB93034WHF0		
510lm 940 7W	white	34°	Q613BW94034WHF0	Q613BB94034WHF0		
490lm 927 7W	gold	34°	Q613BW92734GOF0	Q613BB92734GOF0		
500lm 930 7W	gold	34°	Q613BW93034GOF0	Q613BB93034GOF0		
510lm 940 7W	gold	34°	Q613BW94034GOF0	Q613BB94034GOF0		
490lm 927 7W	black matt	34°	Q613BW92734BMF0	Q613BB92734BMF0		
500lm 930 7W	black matt	34°	Q613BW93034BMF0	Q613BB93034BMF0		
510lm 940 7W	black matt	34°	Q613BW94034BMF0	Q613BB94034BMF0		

Dea Juventas-Q2 XS



Description	reflector	^	white		black	
			white	black	white	black
490lm 927 7W	black high gloss	34°	Q623BW92734BGF0	Q623BB92734BGF0		
500lm 930 7W	black high gloss	34°	Q623BW93034BGF0	Q623BB93034BGF0		
510lm 940 7W	black high gloss	34°	Q623BW94034BGF0	Q623BB94034BGF0		
490lm 927 7W	silver high gloss	34°	Q623BW92734SGF0	Q623BB92734SGF0		
500lm 930 7W	silver high gloss	34°	Q623BW93034SGF0	Q623BB93034SGF0		
510lm 940 7W	silver high gloss	34°	Q623BW94034SGF0	Q623BB94034SGF0		
490lm 927 7W	chrome	34°	Q623BW92734CHF0	Q623BB92734CHF0		
500lm 930 7W	chrome	34°	Q623BW93034CHF0	Q623BB93034CHF0		
510lm 940 7W	chrome	34°	Q623BW94034CHF0	Q623BB94034CHF0		
490lm 927 7W	white	34°	Q623BW92734WHF0	Q623BB92734WHF0		
500lm 930 7W	white	34°	Q623BW93034WHF0	Q623BB93034WHF0		
510lm 940 7W	white	34°	Q623BW94034WHF0	Q623BB94034WHF0		
490lm 927 7W	gold	34°	Q623BW92734GOF0	Q623BB92734GOF0		
500lm 930 7W	gold	34°	Q623BW93034GOF0	Q623BB93034GOF0		
510lm 940 7W	gold	34°	Q623BW94034GOF0	Q623BB94034GOF0		
490lm 927 7W	black matt	34°	Q623BW92734BMF0	Q623BB92734BMF0		
500lm 930 7W	black matt	34°	Q623BW93034BMF0	Q623BB93034BMF0		
510lm 940 7W	black matt	34°	Q623BW94034BMF0	Q623BB94034BMF0		

"The Q-Line 48V track series  
excels in its versatility,  
efficiency and aesthetics."

**Q-Line series**  
48V TRACK SYSTEM

5 years warranty



• **DEA VESTA-Q1 / Q2**

Hearth, home and family. The virgin goddess Vesta was there to protect and cherish these values. The 48V Dea Vesta essentially does the same: this surprisingly small luminaire is developed to bring people together. Her light enriches places in the most efficient way and opens doors to countless creative lighting solutions.



WHITE/GOLD

WHITE/SILVER HIGH GLOSS

WHITE/WHITE

WHITE/BLACK HIGH GLOSS

WHITE/BLACK MATT

WHITE/CHROME



View full specs on [karizmaluce.com](http://karizmaluce.com)

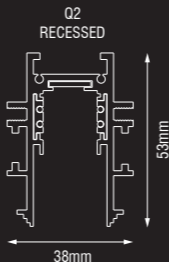
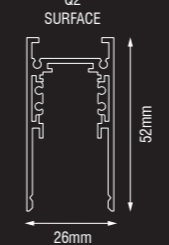
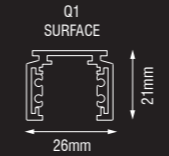

Dea Vesta-Q1 / Q2 XS

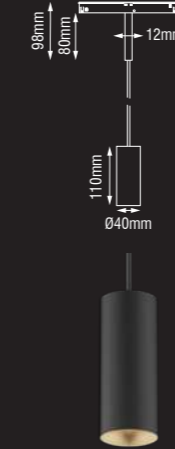

Description	reflector	∧	white	black
490lm 927 7W	black high gloss	34°	Q503BW92734BGF0	Q503BB92734BGF0
500lm 930 7W	black high gloss	34°	Q503BW93034BGF0	Q503BB93034BGF0
510lm 940 7W	black high gloss	34°	Q503BW94034BGF0	Q503BB94034BGF0
490lm 927 7W	silver high gloss	34°	Q503BW92734SGF0	Q503BB92734SGF0
500lm 930 7W	silver high gloss	34°	Q503BW93034SGF0	Q503BB93034SGF0
510lm 940 7W	silver high gloss	34°	Q503BW94034SGF0	Q503BB94034SGF0
490lm 927 7W	chrome	34°	Q503BW92734CHF0	Q503BB92734CHF0
500lm 930 7W	chrome	34°	Q503BW93034CHF0	Q503BB93034CHF0
510lm 940 7W	chrome	34°	Q503BW94034CHF0	Q503BB94034CHF0
490lm 927 7W	white	34°	Q503BW92734WHF0	Q503BB92734WHF0
500lm 930 7W	white	34°	Q503BW93034WHF0	Q503BB93034WHF0
510lm 940 7W	white	34°	Q503BW94034WHF0	Q503BB94034WHF0
490lm 927 7W	gold	34°	Q503BW92734GOF0	Q503BB92734GOF0
500lm 930 7W	gold	34°	Q503BW93034GOF0	Q503BB93034GOF0
510lm 940 7W	gold	34°	Q503BW94034GOF0	Q503BB94034GOF0
490lm 927 7W	black matt	34°	Q503BW92734BMF0	Q503BB92734BMF0
500lm 930 7W	black matt	34°	Q503BW93034BMF0	Q503BB93034BMF0
510lm 940 7W	black matt	34°	Q503BW94034BMF0	Q503BB94034BMF0

Dea Vesta-Q1 / Q2 S

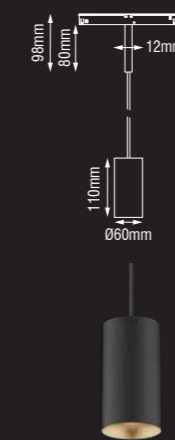

Description	reflector	∧	white	black
790lm 927 10.5W	black high gloss	40°	Q502DW92740BGF0	Q502DB92740BGF0
800lm 930 10.5W	black high gloss	40°	Q502DW93040BGF0	Q502DB93040BGF0
810lm 940 10.5W	black high gloss	40°	Q502DW94040BGF0	Q502DB94040BGF0
790lm 927 10.5W	silver high gloss	40°	Q502DW92740SGF0	Q502DB92740SGF0
800lm 930 10.5W	silver high gloss	40°	Q502DW93040SGF0	Q502DB93040SGF0
810lm 940 10.5W	silver high gloss	40°	Q502DW94040SGF0	Q502DB94040SGF0
790lm 927 10.5W	chrome	40°	Q502DW92740CHF0	Q502DB92740CHF0
800lm 930 10.5W	chrome	40°	Q502DW93040CHF0	Q502DB93040CHF0
810lm 940 10.5W	chrome	40°	Q502DW94040CHF0	Q502DB94040CHF0
790lm 927 10.5W	white	40°	Q502DW92740WHF0	Q502DB92740WHF0
800lm 930 10.5W	white	40°	Q502DW93040WHF0	Q502DB93040WHF0
810lm 940 10.5W	white	40°	Q502DW94040WHF0	Q502DB94040WHF0
790lm 927 10.5W	gold	40°	Q502DW92740GOF0	Q502DB92740GOF0
800lm 930 10.5W	gold	40°	Q502DW93040GOF0	Q502DB93040GOF0
810lm 940 10.5W	gold	40°	Q502DW94040GOF0	Q502DB94040GOF0
790lm 927 10.5W	black matt	40°	Q502DW92740BMF0	Q502DB92740BMF0
800lm 930 10.5W	black matt	40°	Q502DW93040BMF0	Q502DB93040BMF0
810lm 940 10.5W	black matt	40°	Q502DW94040BMF0	Q502DB94040BMF0

**Q-Line series**  
48V TRACK SYSTEM

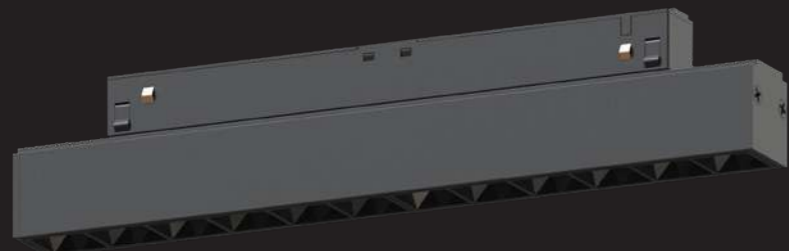

LINEA-Q1 Q2 LENS S

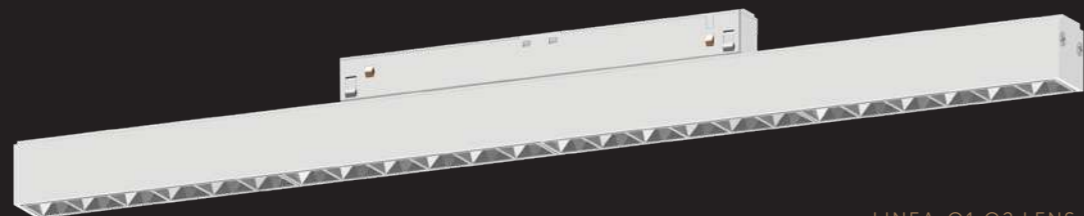

LINEA-Q1 Q2 LENS L

• **LINEA LENS**

The Italian meaning of Linea is 'line' and that is exactly what this 48V linear luminaire of our Q-Line series creates. Clicked in a subtle 48V recessed, surface or suspended track rail, the adjustable track light with parabolic louvre creates a stunning and perfect straight line of light. Available with 15°, 30° and 45° beam angles. Available in black and white.

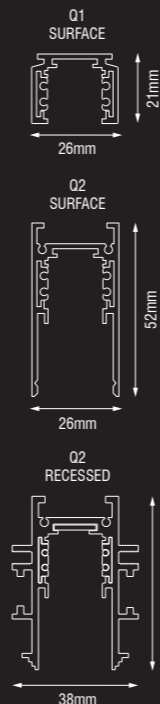

**Linea-Q1 LENS XS**

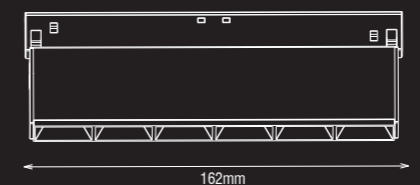

Description	∧	white	black
650lm 930 10W	15°	Q646CW93015F0	Q646CB93015F0
700lm 940 10W	15°	Q646CW94015F0	Q646CB94015F0
650lm 930 10W	30°	Q646CW93030F0	Q646CB93030F0
700lm 940 10W	30°	Q646CW94030F0	Q646CB94030F0
650lm 930 10W	45°	Q646CW93045F0	Q646CB93045F0
700lm 940 10W	45°	Q646CW94045F0	Q646CB94045F0

**Linea-Q1 LENS M**

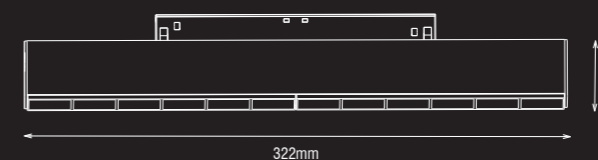

Description	∧	white	black
1300lm 930 20W	15°	Q647FW93015F0	Q647FB93015F0
1400lm 940 20W	15°	Q647FW94015F0	Q647FB94015F0
1300lm 930 20W	30°	Q647FW93030F0	Q647FB93030F0
1400lm 940 20W	30°	Q647FW94030F0	Q647FB94030F0
1300lm 930 20W	45°	Q647FW93045F0	Q647FB93045F0
1400lm 940 20W	45°	Q647FW94045F0	Q647FB94045F0

**Linea-Q1 Q2 LENS S**

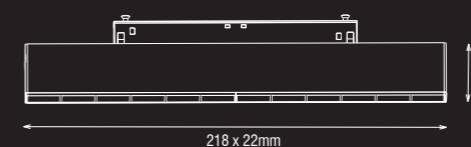

Description	∧	white	black
1000lm 930 14W	15°	Q651DW93015F0	Q651DB93015F0
1100lm 940 14W	15°	Q651DW94015F0	Q651DB94015F0
1000lm 930 14W	30°	Q651DW93030F0	Q651DB93030F0
1100lm 940 14W	30°	Q651DW94030F0	Q651DB94030F0
1000lm 930 14W	45°	Q651DW93045F0	Q651DB93045F0
1100lm 940 14W	45°	Q651DW94045F0	Q651DB94045F0

**Linea-Q1 Q2 LENS L**

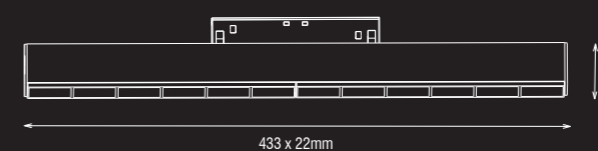

Description	∧	white	black
1800lm 930 28W	15°	Q652HW93015F0	Q652HB93015F0
1950lm 940 28W	15°	Q652HW94015F0	Q652HB94015F0
1800lm 930 28W	30°	Q652HW93030F0	Q652HB93030F0
1950lm 940 28W	30°	Q652HW94030F0	Q652HB94030F0
1800lm 930 28W	45°	Q652HW93045F0	Q652HB93045F0
1950lm 940 28W	45°	Q652HW94045F0	Q652HB94045F0

**Q-Line series**  
48V TRACK SYSTEM

5 years warranty

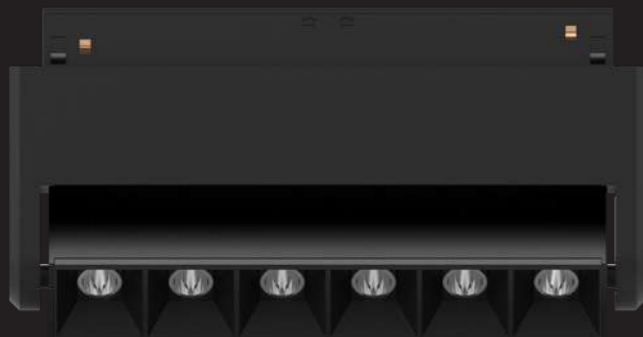

LINEA-Q1 LENS XS ADJUSTABLE

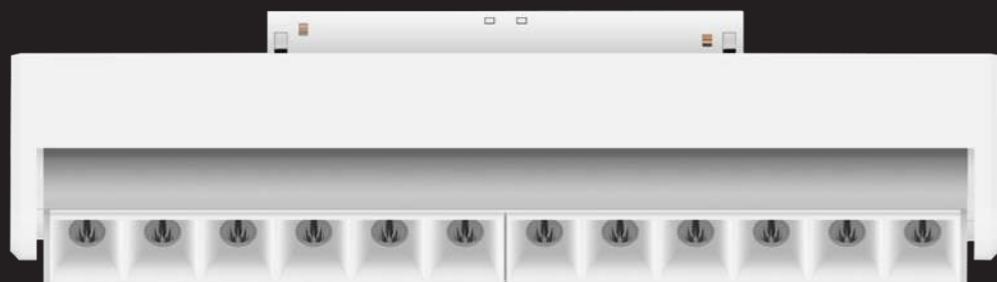

LINEA-Q1 LENS M ADJUSTABLE

• **LINEA LENS ADJUSTABLE**

Optimize your lighting solution with the 85° adjustable Linea LENS Adjustable. The adjustable optical part, parabolic louvre and different beam angles (15°, 30° and 45°) makes the Linea LENS Adjustable a big tribute to your lighting plan. Minimalistic designed, but yet with great impact. Available in black and white.

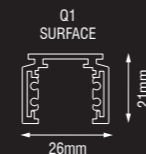

**Linea-Q1 LENS XS ADJUSTABLE**

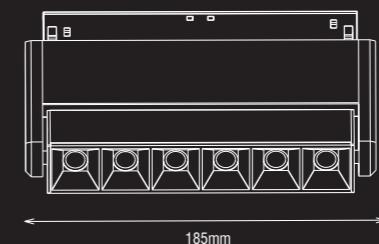

Description	∧	white	black
650lm 930 10W	15°	Q648CW93015F0	Q648CB93015F0
700lm 940 10W	15°	Q648CW94015F0	Q648CB94015F0
650lm 930 10W	30°	Q648CW93030F0	Q648CB93030F0
700lm 940 10W	30°	Q648CW94030F0	Q648CB94030F0
650lm 930 10W	45°	Q648CW93045F0	Q648CB93045F0
700lm 940 10W	45°	Q648CW94045F0	Q648CB94045F0

**Linea-Q1 LENS M ADJUSTABLE**

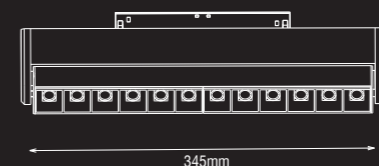

Description	∧	white	black
1300lm 930 20W	15°	Q649FW93015F0	Q649FB93015F0
1400lm 940 20W	15°	Q649FW94015F0	Q649FB94015F0
1300lm 930 20W	30°	Q649FW93030F0	Q649FB93030F0
1400lm 940 20W	30°	Q649FW94030F0	Q649FB94030F0
1300lm 930 20W	45°	Q649FW93045F0	Q649FB93045F0
1400lm 940 20W	45°	Q649FW94045F0	Q649FB94045F0

**Q-Line series**  
48V TRACK SYSTEM

5 years warranty



LINEA-Q1 Q2 OPAL L

LINEA-Q1 Q2 OPAL S

• **LINEA OPAL**

A stunning and perfect straight line of light is what this Linea luminaire with opal diffuser creates. Thanks to 48V low voltage track it is easy to assemble, just simply click the fixture in a subtle recessed, surface or suspended track rail, and have a vibrant lighting solution for years to come. Available with a beam angle of 90° and black and white housing.

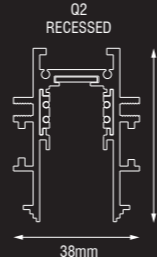
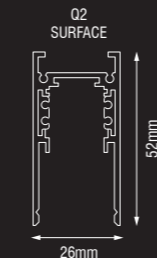
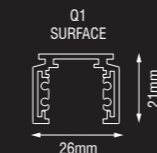

**Linea-Q1 OPAL M**



Description	Beam Angle	white	black
1300lm 930 20W	90°	Q650FW93090F0	Q650FB93090F0
1400lm 940 20W	90°	Q650FW94090F0	Q650FB94090F0

**Linea-Q1 Q2 OPAL S**



Description	Beam Angle	white	black
1000lm 930 14W	90°	Q653DW93090F0	Q653DB93090F0
1100lm 940 14W	90°	Q653DW94090F0	Q653DB94090F0

**Linea-Q1 Q2 OPAL L**



Description	Beam Angle	white	black
1800lm 930 28W	90°	Q654HW93015F0	Q654HB93015F0
1950lm 940 28W	90°	Q654HW94015F0	Q654HB94015F0

# Q-Line series

## 48V TRACK PARTS

48V-Q1 SURFACE MINI TRACK RAIL

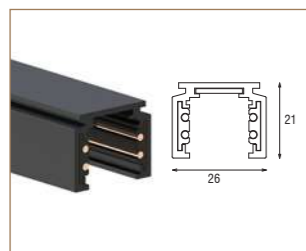

<b>CX-M10-BL</b>	48V-Q1 1000mm	black
<b>CX-M10-WH</b>	48V-Q1 1000mm	white
<b>CX-M15-BL</b>	48V-Q1 1500mm	black
<b>CX-M15-WH</b>	48V-Q1 1500mm	white
<b>CX-M20-BL</b>	48V-Q1 2000mm	black
<b>CX-M20-WH</b>	48V-Q1 2000mm	white

48V-Q2 SURFACE HIGH TRACK RAIL

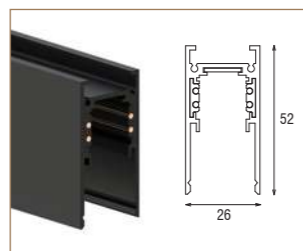

<b>CX-MA10-BL</b>	48V-Q2 1000mm	black
<b>CX-MA10-WH</b>	48V-Q2 1000mm	white
<b>CX-MA15-BL</b>	48V-Q2 1500mm	black
<b>CX-MA15-WH</b>	48V-Q2 1500mm	white
<b>CX-MA20-BL</b>	48V-Q2 2000mm	black
<b>CX-MA20-WH</b>	48V-Q2 2000mm	white

48V-Q2 RECESSED TRIMLESS HIGH RAIL

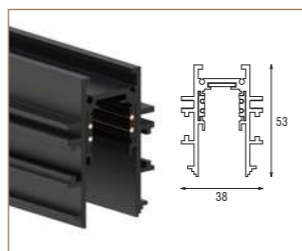

<b>CX-MD10-BL</b>	48V-Q2 1000mm	black
<b>CX-MD10-WH</b>	48V-Q2 1000mm	white
<b>CX-MD15-BL</b>	48V-Q2 1500mm	black
<b>CX-MD15-WH</b>	48V-Q2 1500mm	white
<b>CX-MD20-BL</b>	48V-Q2 2000mm	black
<b>CX-MD20-WH</b>	48V-Q2 2000mm	white

48V-Q2 EMBEDDED BRACKET

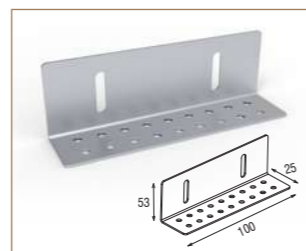

**CX-MD24** 48V-Q2 for CX-MD10/15/20 + 2 screws

48V-Q1 SUSPENSION SET



**CX-M021** 48V-Q1 1m CX-M10/15/20 mini

48V-Q2 SUSPENSION SET



**CX-M020** 48V-Q2 1m MA10/15/20

48V-Q1 ALUMINIUM CONNECTION



**CX-M022** 48V-Q1 CX-M10/15/20 mini

48V-Q2 ALUMINIUM CONNECTION

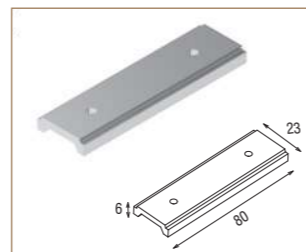

**CX-M023** 48V-Q2 CX-MA10/15/20

48V-Q1 ENDCAP HOLE MINI



**CX-M025-BL** 48V-Q1 for CX-M10/15/20 black  
**CX-M025-WH** 48V-Q1 for CX-M10/15/20 white

48V-Q1 ENDCAP CLOSED MINI

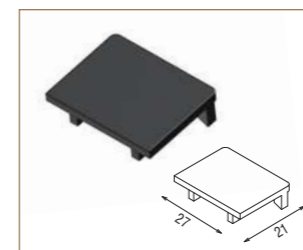

**CX-M026-BL** 48V-Q1 for CX-M10/15/20 black  
**CX-M026-WH** 48V-Q1 for CX-M10/15/20 white

48V-Q2 ENDCAP HOLE HIGH

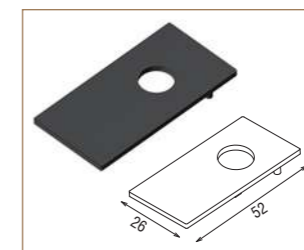

**CX-M029-BL** 48V-Q2 black  
**CX-M029-WH** 48V-Q2 white

48V-Q2 ENDCAP CLOSED HIGH

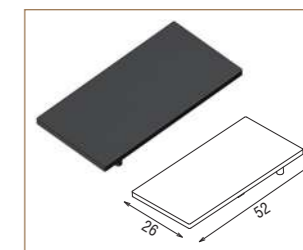

**CX-M030-BL** 48V-Q2 black  
**CX-M030-WH** 48V-Q2 white

48V-Q1/Q2 END FEED



**CX-M031-BL** 48V-Q1/Q2 black  
**CX-M031-WH** 48V-Q1/Q2 white

48V-Q1/Q2 STRAIGHT JOINT



**CX-M032-BL** 48V-Q1/Q2 black  
**CX-M032-WH** 48V-Q1/Q2 white

48V-Q1 CONNECTOR MINI

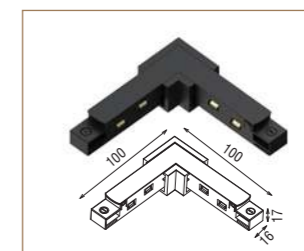

**CX-M033-BL** 48V-Q1 L mini black  
**CX-M033-WH** 48V-Q1 L mini white

48V-Q2 CONNECTOR HIGH

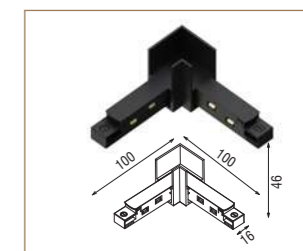

**CX-M034-BL** 48V-Q2 L high black  
**CX-M034-WH** 48V-Q2 L high white

48V-Q1/Q2 FLEXIBLE CONNECTOR



**CX-M035-BL** 48V-Q1/Q2 black  
**CX-M035-WH** 48V-Q1/Q2 white

48V-Q2 ANGLE CONNECTION BRACKET

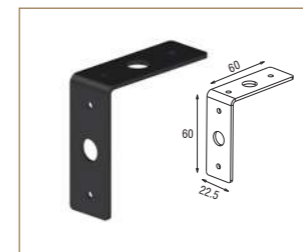

**CX-M036** 48V-Q2 high black

48V-Q2 CONNECTOR SHEET

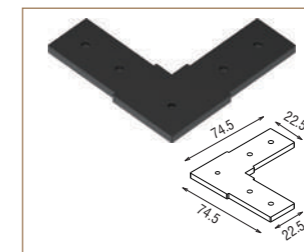

**CX-M037-BL** 48V-Q2 L high black



# INSTALLATION MANUAL

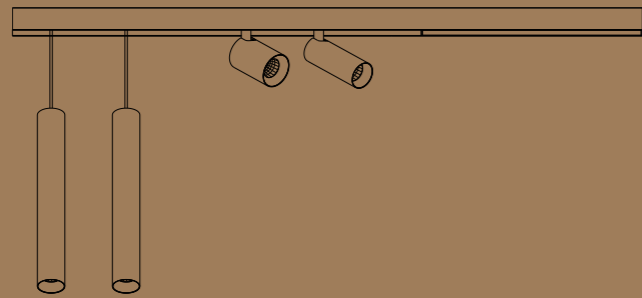

**Q-Line series**  
48V TRACK SYSTEM

## CAFE

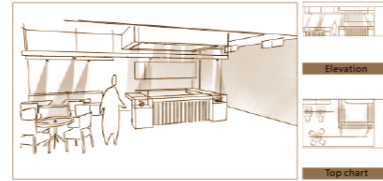

## OFFICE



## STORE

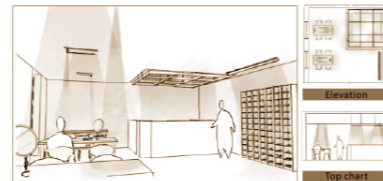

## SHOWROOM



## BAR



## RECESSED TRACK

48V TRACK SYSTEM

Q2

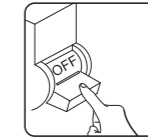

Turn off the power supply before carrying out any installation, maintenance or repair work

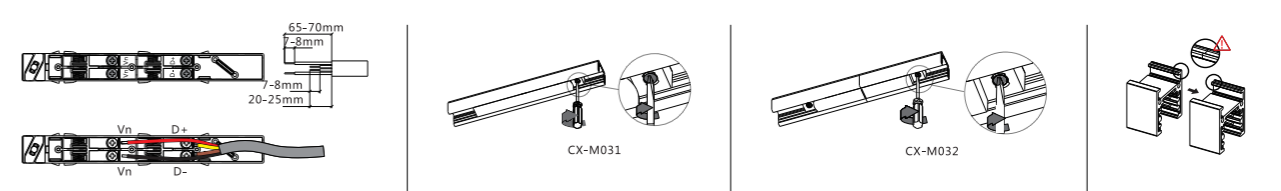
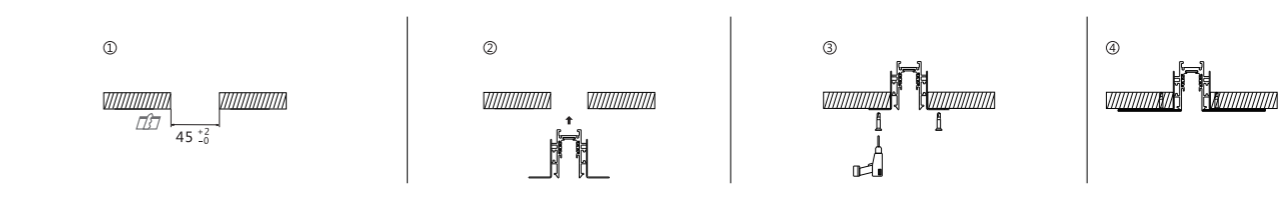
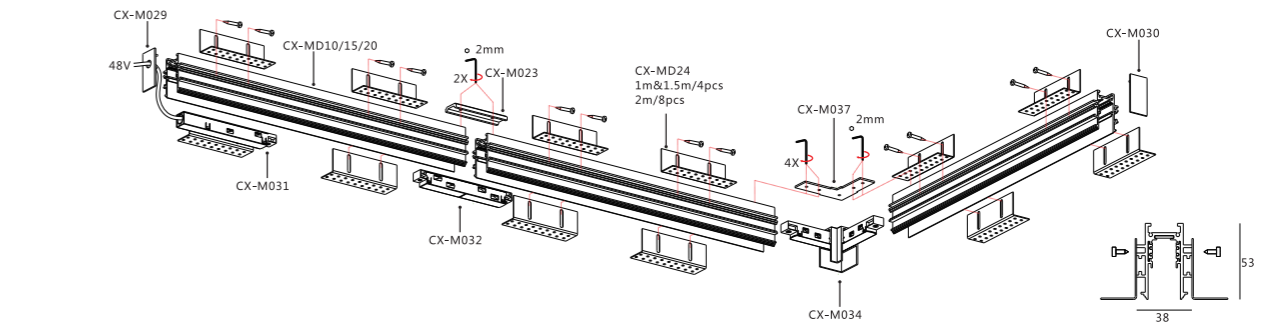

**SURFACE TRACK**  
48V TRACK SYSTEM

Q1

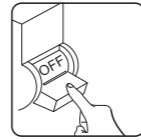

Turn off the power supply before carrying out any installation, maintenance or re pair work

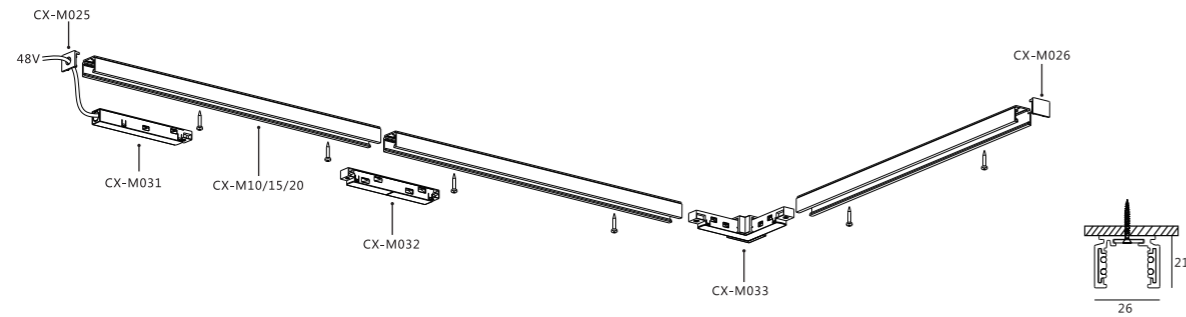

**SURFACE TRACK**  
48V TRACK SYSTEM

Q2

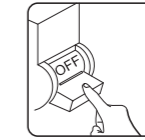

Turn off the power supply before carrying out any installation, maintenance or re pair work

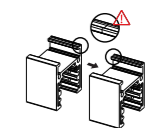
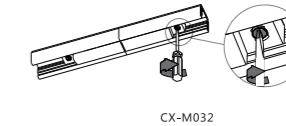
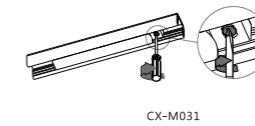
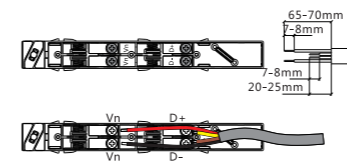
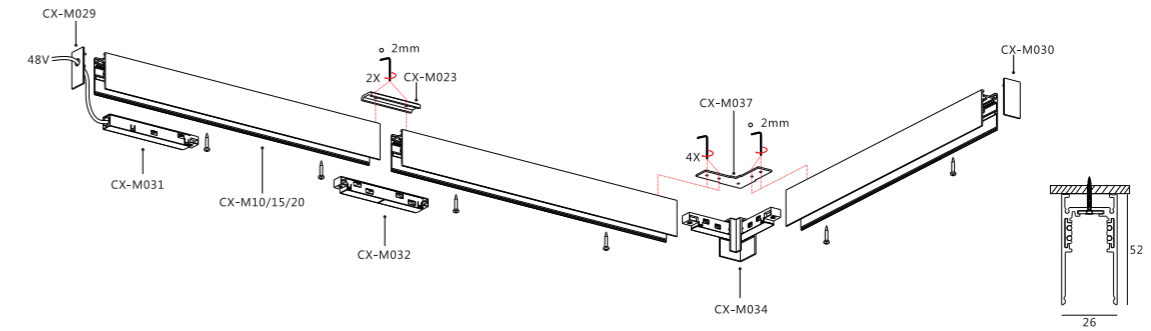

**SUSPENDED TRACK**

48V TRACK SYSTEM

Q1

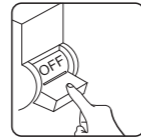

Turn off the power supply before carrying out any installation, maintenance or repair work

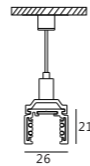
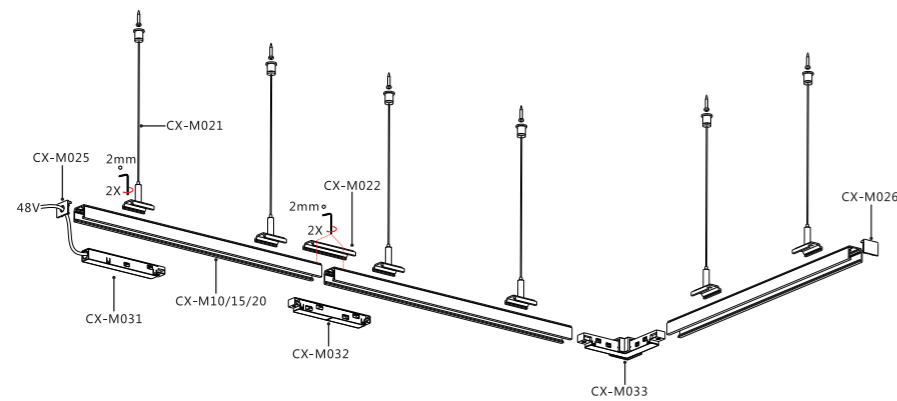

**SUSPENDED TRACK**

48V TRACK SYSTEM

Q2

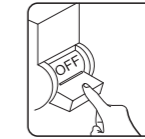

Turn off the power supply before carrying out any installation, maintenance or repair work

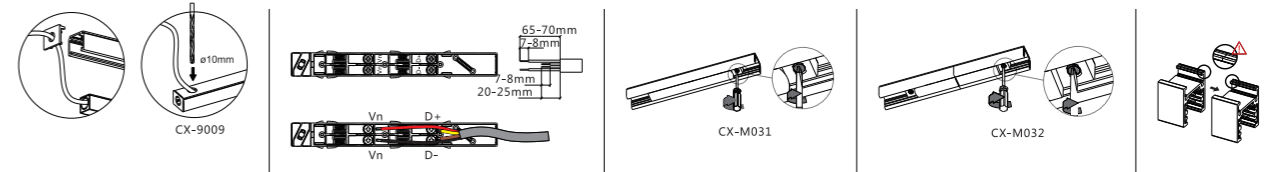
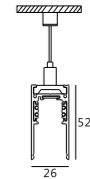
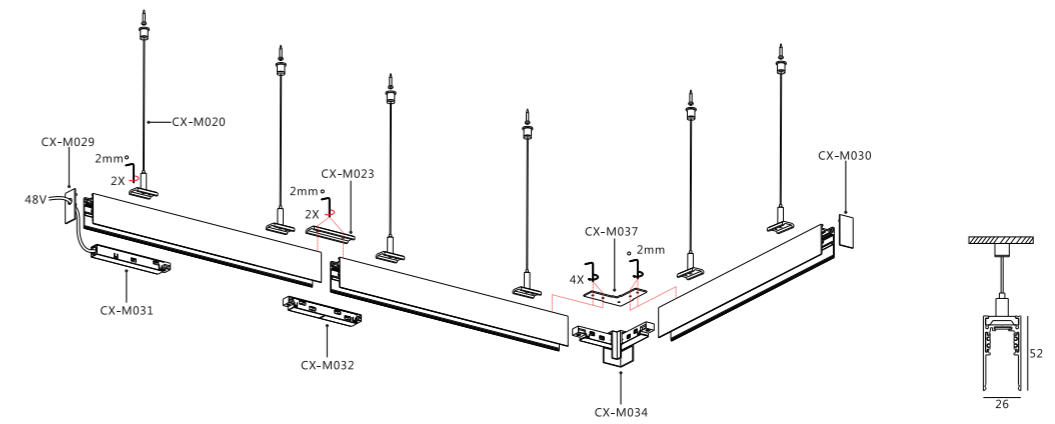

**END FEED**  
48V TRACK SYSTEM

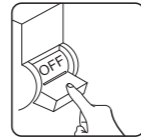

Turn off the power supply before carrying out any installation, maintenance or repair work

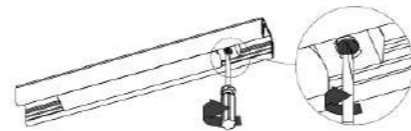
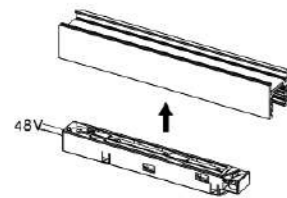
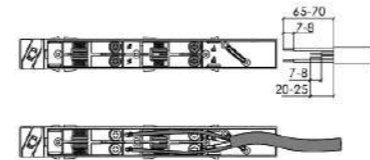
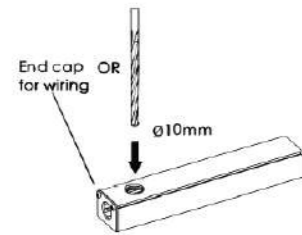
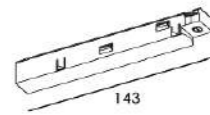

**STRAIGHT JOINT**  
48V TRACK SYSTEM

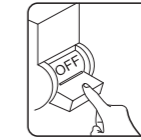

Turn off the power supply before carrying out any installation, maintenance or repair work

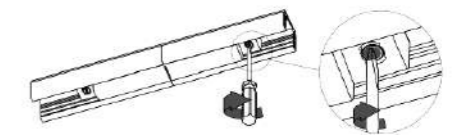
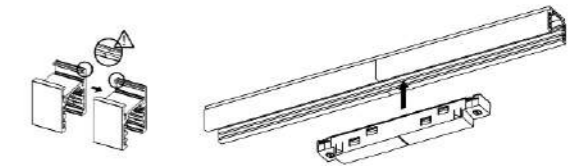
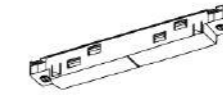
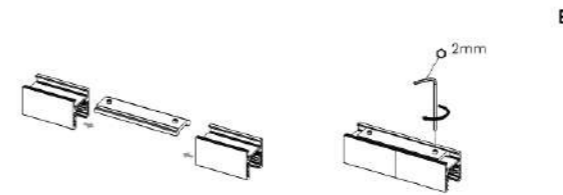
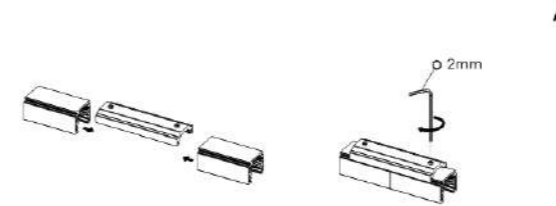

**PART A**  
48V TRACK SYSTEM

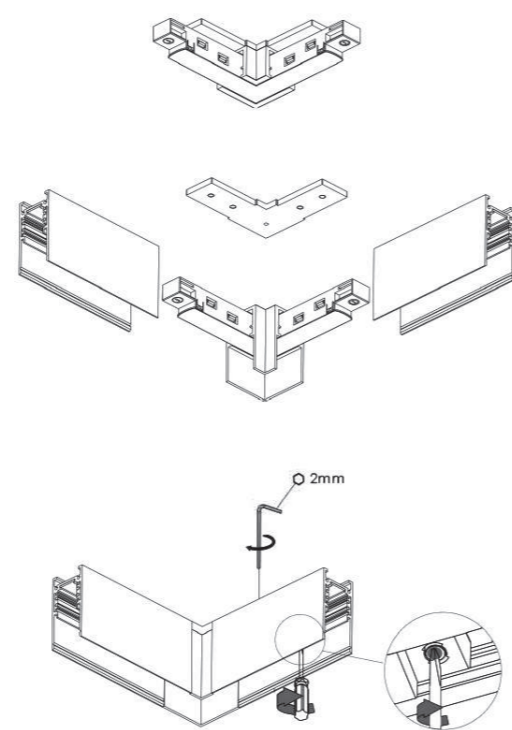
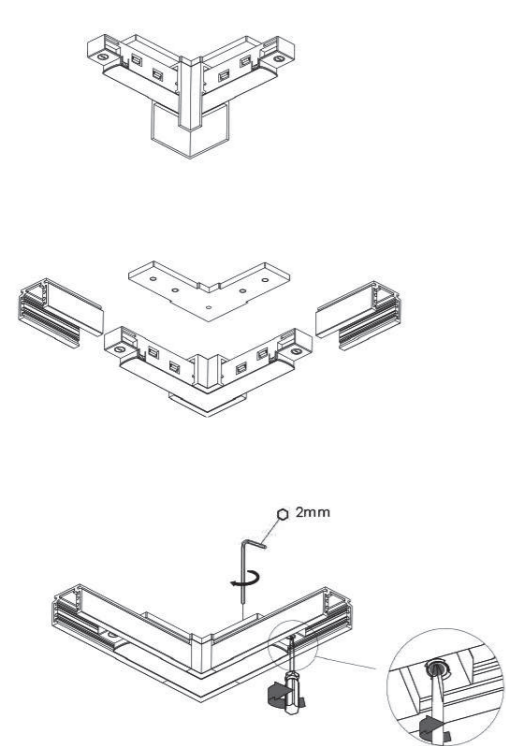

**PART B**  
48V TRACK SYSTEM

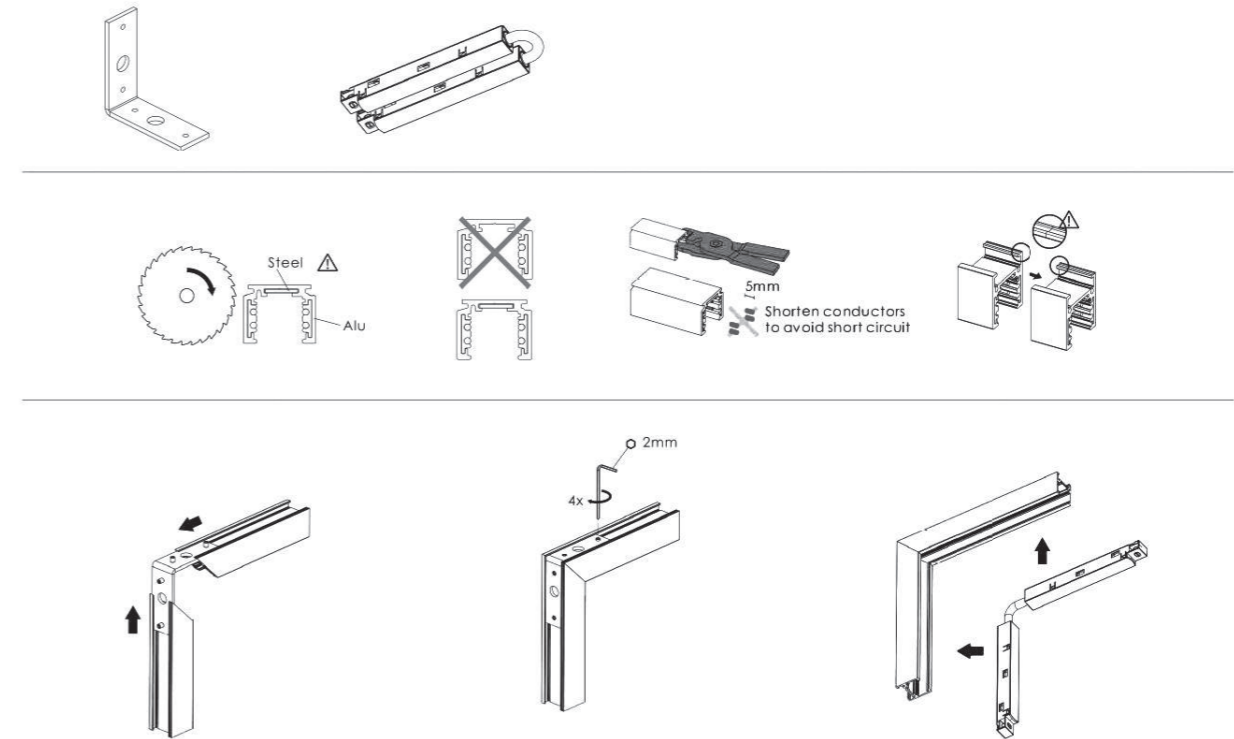

**WIRING DIAGRAMS**

48V TRACK SYSTEM

On/Off

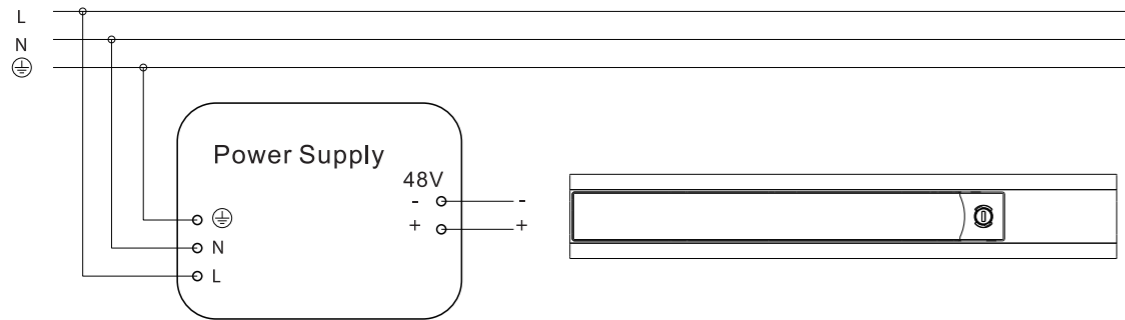

Dali

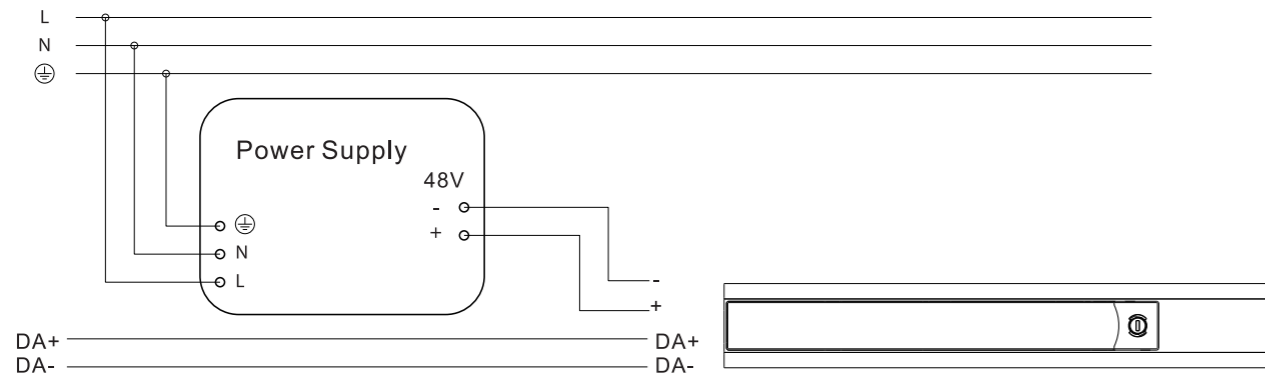

KARIZMA LUCE B.V.

SNEEKERMEER 4A

8502 TP JOURE

THE NETHERLANDS

+31 (0)513 226008

INFO@KARIZMALUCE.COM

KARIZMALUCE.COM

