

SEC[®]

Lighting

EST.1992



PROFESSIONAL LIGHTING SOLUTIONS

EDITION **2020/2021**

Emergency Lighting
Architectural Lighting
LightBox / Informational Lighting
Núdzové Svietidlá
Interiérové svietidlá
Informačné svietidlá

CBS & CentralTest Systems

CENTRALTEST	34-39
ELMAX-ATXL-MINI	34-37
ELMAX-ATRF-MINI WIRELESS	38-39



CBS CENTRALTEST / CBS	40-47
CBS ADDRESSABLE PATROLUX	40-43
CBS EPS DIGITAL	44-47



PREMIUM Line

Page No. 48-151

EVOLUX2-P LED	52-59
MULTIEVO2-P LED 1h/3h	52-59
MULTIEVO2-P LED 1h/3h DALI	52-59
C.EVOLUX2-P LED 230V AC/DC	52-59
C.EVOLUX2-P LED 24V AC/DC	52-59
C.EVOLUX2-P LED 230V DALI	52-59
EVOLUX2-PP LED	60-61
MULTIEVO2-PP LED 1h/3h	60-61
MULTIEVO2-PP LED 1h/3h DALI	60-61
C.EVOLUX2-PP LED 230V AC/DC	60-61
C.EVOLUX2-PP LED 24V AC/DC	60-61
C.EVOLUX2-PP LED 230V DALI	60-61
EVOLUX2-VP LED	62-65
MULTIEVO2-VP LED 1h/3h	62-65
MULTIEVO2-VP LED 1h/3h DALI	62-65
C.EVOLUX2-VP LED 230V AC/DC	62-65
C.EVOLUX2-VP LED 24V AC/DC	62-65
C.EVOLUX2-VP LED 230V DALI	62-65
EVOLUX2-V LED	66-67
MULTIEVO2-V LED 1h/3h	66-67
MULTIEVO2-V LED 1h/3h DALI	66-67
C.EVOLUX2-V LED 230V AC/DC	66-67
C.EVOLUX2-V LED 24V AC/DC	66-67
C.EVOLUX2-V LED 230V DALI	66-67
TRENDLUX2 LED	68-73
MULTITREND2 LED 1h/3h	68-73
MULTITREND2 LED 1h/3h DALI	68-73
C.TRENDLUX2 230V AC/DC	68-73
C.TRENDLUX2 24V AC/DC	68-73
C.TRENDLUX2 230V DALI	68-73



EMERGENCY LIGHTING: PREMIUM LINE

CONTENTS



68-73	TRENDLUX2 LED
68-73	MULTITREND2 LED 1h/3h
68-73	MULTITREND2 LED 1h/3h DALI
68-73	C.TRENDLUX2 230V AC/DC
68-73	C.TRENDLUX2 24V AC/DC
68-73	C.TRENDLUX2 230V DALI
74-77	TRENDLUX2-TOP LED
74-77	MULTITREND2-TOP LED 1h/3h
74-77	MULTITREND2-TOP LED 1h/3h DALI
74-77	C.TRENDLUX2-TOP 230V AC/DC
74-77	C.TRENDLUX2-TOP 24V AC/DC
74-77	C.TRENDLUX2-TOP 230V DALI
78-83	NORMALUX2 LED
78-83	MULTINORMA2-AT 1h/3h
78-83	C.NORMALUX 230V AC/DC
78-83	C.NORMALUX 24V AC/DC
84-91	PRIMALUX-A/-B LED
84-91	MULTIPRIMA-A-AT 1h/3h / DALI
84-91	MULTIPRIMA-B-AT 1h
84-91	MULTIPRIMA-A+2xLED 1h/3h
84-91	C.PRIMALUX-A/-B 230V / DALI
84-91	C.PRIMALUX-A/-B 24V AC/DC
92-97	PRIMALUX-AP LED
92-97	MULTIPRIMA-AP 1h/3h / DALI
92-97	MULTIPRIMA-APA+2xLED 1h/3h
92-97	MULTIPRIMA-APB+2xLED 1h/3h
92-97	C.PRIMALUX-AP 230V / 24V AC/DC
92-97	C.PRIMALUX-AP/APA/APB 230V / 24V AC/DC
98-101	PRIMALUX-AV LED
98-101	MULTIPRIMA-AV 1h/3h / DALI
98-101	MULTIPRIMA-AVA+2xLED 1h/3h
98-101	MULTIPRIMA-AVB+2xLED 1h/3h
98-101	C.PRIMALUX-AV 230V / 24V AC/DC
98-101	C.PRIMALUX-AV/AVA/AVB 230V / 24V AC/DC
102-105	FALCON-P / FALCON-V
102-105	FALCON-AT 1h/3h
102-105	FALCON 1h/3h DALI
102-105	C.FALCON 230V DALI
102-105	C.FALCON 24V AC/DC
102-105	C.FALCON 230V AC/DC
106-114	LEDLUX2-P
106-114	MULTILED2-P-AT 1h/3h
106-114	MULTILED2-P-DALI 1h/3h
106-114	C.LEDLUX2-P 230V AC/DC
106-114	C.LEDLUX2-P 24V AC/DC
106-114	C.LEDLUX2-P 230V DALI
115-119	LEDLUX2-V
115-119	MULTILED2-V-AT 1h/3h
115-119	MULTILED2-V-DALI 1h/3h
115-119	C.LEDLUX2-V 230V AC/DC
115-119	C.LEDLUX2-V 24V AC/DC
115-119	C.LEDLUX2-V 230V DALI

EMERGENCY LIGHTING: PREMIUM LINE

LEDLUX-R	120-123
MULTILED2-R-AT LED 3h	120-123
MULTILED2-R 3h DALI	120-123
C.LEDLUX2-R 230V DALI	120-123
C.LEDLUX2-R 24V AC/DC	120-123
C.LEDLUX2-R 230V DALI	120-123
LEDLUX-R	120-123
MULTILED2-R-AT LED 3h	120-123
MULTILED2-R 3h DALI	120-123
C.LEDLUX2-R 230V DALI	120-123
C.LEDLUX2-R 24V AC/DC	120-123
C.LEDLUX2-R 230V DALI	120-123
TRACKLUX	124-127
TRACKLUX-AT 1-3h + DALI	124-127
TRACKLUX-AT-A+2xLED 1-3h	124-127
TRACKLUX-AT-B+2xLED 1-3h	124-127
C.TRACKLUX LED 230V AC/DC	124-127
C.TRACKLUX LED 230V DALI	124-127
TRIPLELUX2 LED	130-131
MULTITRIPLE2-AT LED 1h	130-131
MULTITRIPLE2-AT-A+1xLED LED 1h	130-131
MULTITRIPLE2-AT-B+1xLED LED 1h	130-131
C.TRIPLELUX2 LED 230V AC/DC	130-131
C.TRIPLELUX2-A/-B LED 230V	130-131
ARRISLUX2 LED	128-129
MULTIARRIS2-AT LED 1h	128-129
MULTIARRIS2-AT-A+1xLED LED 1h	128-129
MULTIARRIS2-AT-B+1xLED LED 1h	128-129
C.ARRISLUX2 LED 230V AC/DC	128-129
C.ARRISLUX2-A/-B+1xLED 230V	128-129
LEGEND L/XL	132-135
LEGEND-AT 1-3h	132-135
LEGEND 1-3h DALI	132-135
C.LEGEND 230V AC/DC	132-135
C.LEGEND 24V AC/DC	132-135
C.LEGEND 230V DALI	132-135
LEDLUX-SPOT2-V	133-145
MULTILED-SPOT2-A-V 1h/3h +DALI	136-145
MULTILED-SPOT2-B-V 1h/3h +DALI	136-145
C.LEDLUX-SPOT2-A-V 230V / 24V	136-145
C.LEDLUX-SPOT2-B-V 230V / 24V	136-145
C.LEDLUX-SPOT2-V 230V DALI	136-145
LEDLUX-SPOT2-P	146-151
MULTILED-SPOT2-A-P 1h/3h +DALI	146-151
MULTILED-SPOT2-B-P 1h/3h +DALI	146-151
C.LEDLUX-SPOT2-A-P 230V / 24V	146-151
C.LEDLUX-SPOT2-B-P 230V / 24V	146-151
C.LEDLUX-SPOT2-230V DALI	146-151
1LX SPACING TABLES	210-217
1LUX SPACING TABLES - CEILING	210-217
1LUX SPACING TABLES - WALL	210-217



HIGH CEILING APPLICATIONS

Page No. 152-169

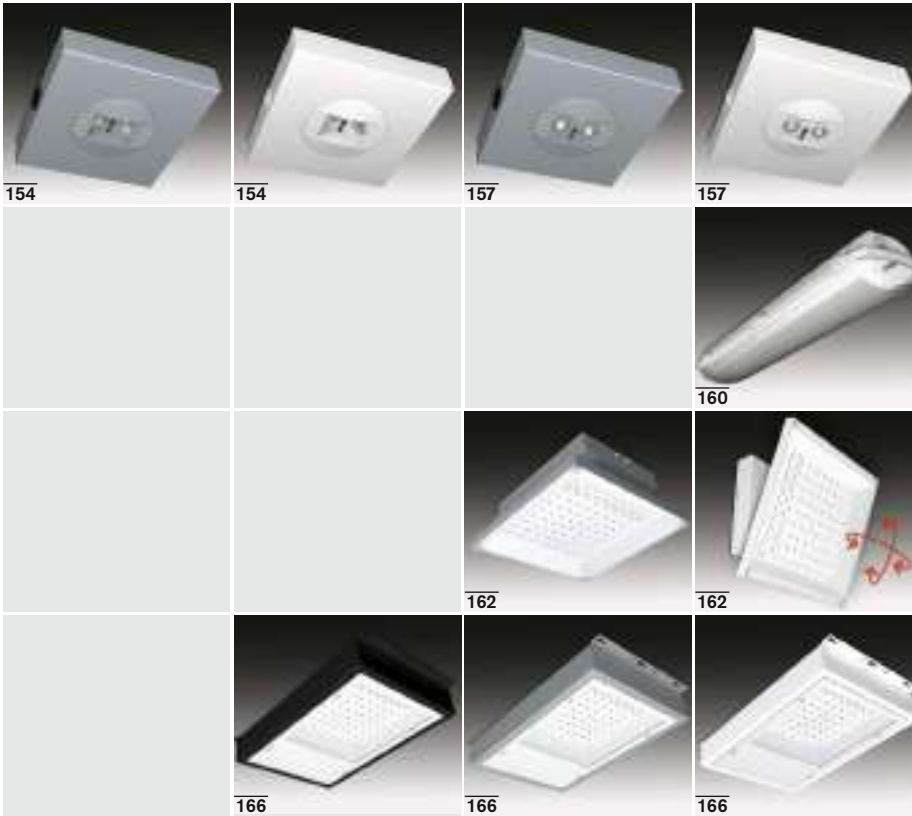

154-159	LEDLUX-SPOT2-HCA/-HCB
154-156	MULTILED-SPOT2-HCA 1h + DALI
157-159	MULTILED-SPOT2-HCB 1h + DALI
154-156	C.LEDLUX-SPOT2-HCA 230/24V AC/DC
157-159	C.LEDLUX-SPOT2-HCB 230/24V AC/DC
154-159	C.LEDLUX-SPOT2-HCA/-HCB 230V DALI
160-161	PERUN2
160-161	PERUN2-AT 1h
160-161	PERUN2 1h DALI
160-161	C.PERUN2 230V AC/DC
160-161	C.PERUN2 24V AC/DC
160-161	C.PERUN2 230V DALI
162-164	ROTALUX2 LED
162-164	MULTIROTALUX2-AT 1h
162-164	MULTIROTALUX2 1h DALI
162-164	C.ROTALUX 230V AC/DC
162-164	C.ROTALUX 24V AC/DC
162-164	C.ROTALUX 230V DALI
165-169	POWERLUX2
165-169	MULTIPOWER2-AT 1h
165-169	MULTIPOWER2 1h DALI
165-169	C.POWERLUX 230V AC/DC
165-169	C.POWERLUX 24V AC/DC
165-169	C.POWERLUX 230V DALI

NO-AT CINEMA APPLICATIONS

Page No. 170-181



176-179	LEDLUX-SPOT2 NO-AT
176-177	MULTILED-SPOT2-A-V 1h/3h NO-AT
178-179	MULTILED-SPOT2-A-P 1h/3h NO-AT
176-177	MULTILED-SPOT2-B-V 1h/3h NO-AT
178-179	MULTILED-SPOT2-B-P 1h/3h NO-AT
172-173	LEDLUX NO-AT
172-173	MULTILED2-P 3h NO-AT
172-173	MULTILED2-V 3h NO-AT
180-181	POWERLUX2 NO-AT
180-181	MULTIPOWER2 1h NO-AT

STANDARD Line

Page No. 182-209

MINILED RETROFIT LED TUBE	183
MINILED RETROFIT LED TUBE	183
PICTORLUX 8W/LED	184-185
PICTORLUX / MULTIPIC TOR 8W 1h	184-185
MULTIPIC TOR LED 1h/3h	184-185
C.PICTORLUX 8W 230V AC/DC	184-185
C.PICTORLUX LED 230V AC/DC	184-185
LEDLUX-P	186-191
MULTILED-P 3h	186-191
MULTILED-P-AT 1h/3h	186-191
C.LEDLUX-P 230V AC/DC	186-191
C.LEDLUX-P 24V AC/DC	186-191
LEDLUX-V	192-197
MULTILED-V 3h	192-197
MULTILED-V-AT 1h/3h	192-197
C.LEDLUX-V 230V AC/DC	192-197
C.LEDLUX-V 24V AC/DC	192-197
CUBELUX LED	199-203
MULTICUBE-220-AT 5xLED/1h	199-203
C.CUBELUX-220 5xLED/24V/230V	199-203
HILLUX LED	204-205
MULTIHILL-AT 5xLED 1/3h	204-205
C.HILLUX LED 230V AC/DC	204-205
C.HILLUX LED 110V DC	204-205
EXITLUX3 LED	206-209
MULTIEXIT3 LED 1h	206-209
1LX SPACING TABLES	210-217
1LUX SPACING TABLES - CEILING	210-217
1LUX SPACING TABLES - WALL	210-217



Product Assortment

EMERGENCY LIGHTING

Premium Line



- **4 YEARS WARRANTY ***

- 4 ročná záruka *



- **POWERFULL LEDs >150lm/W**

- Výkonné LED >150lm/W



- **LONGLIFE LEDs >100.000h**

- Dlhoživotné LED >100000hod



- **LONGLIFE LIFEPO4 BATTERY**

- Dlhoživotná LIFEPO4 batéria



- **INSTALATION MODE**

- Inštalačný mód



- **INTELLIGENT CHARGING** (for NiMh batteries)

- Inteligentné nabíjanie (pre NiMh batérie)



- **ECO MODE (dimming 10%-100%)**

- ECO mód (stmievanie 10%-100%)



2/200
cd/m²

- **ENERGY SAVING MODE (picto illumination 2cd/m² or 200cd/m²)**

- "Energy Saving" mód (osvetlenie piktogramu 2cd/m² alebo 200cd/m²)



- **POWER FACTOR >0.9**

- Power faktor >0,9

*4 years warranty does not include the battery

*4 ročná záruka nezahrňuje batériu



FEATURES PREMIUM LINE

THIS IS ONLY EXAMPLE OF DIP SWITCH PREMIUM EMERGENCY LIGHTING VERSION FUNCTIONALITY. FOR DETAILED SPECIFIC TYPE FUNCTIONALITY PLEASE REFER TO ITS CATALOGUE PAGE.

TÁTO TABUĽKA ÚVÁDZA PRÍKLADY FUNKCIONALITY DIP PREPÍNAČA PRE PREMIUM VERZIE NÚDZOVÝCH SVIETIDIEL. PRE DETAILNÚ FUNKCIONALITU DANÉHO SVIETIDLA POZRI ĎALEJ V KATALÓGU.



DIP SWITCH FEATURES No.1-4 / DIP PREPÍNAČ ě.1-4 - FUNKCIE

SELF-CONTAINED BATTERY VERSIONS

NORMAL MODE 230V MAINS	EMERGENCY BATTERY MODE	+2xLED BOTTOM LEDs ACTIVATION
+2xLED BOTTOM LEDs ACTIVATION		ON - ACTIVATED OFF - DEACTIVATED
		DEFAULT SETT. / PREDNASTAVENÉ Full Power
		ECO MODE 50% (in 230V mode) EMERGENCY MODE LEGEND BRIGHTNESS > 200cd/m²
		ECO MODE 25% (in 230V mode) EMERGENCY MODE LEGEND BRIGHTNESS > 200cd/m²
		ECO MODE 10% (in 230V mode) EMERGENCY MODE LEGEND BRIGHTNESS > 200cd/m²
		ENERGY SAVING (in emerg.mode) LEGEND BRIGHTNESS > 2cd/m² JAS PIKTOGRAMU > 2cd/m²
		ENERGY SAVING (in emerg.mode) LEGEND BRIGHTNESS > 2cd/m² JAS PIKTOGRAMU > 2cd/m²
		ENERGY SAVING (in emerg.mode) LEGEND BRIGHTNESS > 2cd/m² JAS PIKTOGRAMU > 2cd/m²
		ENERGY SAVING (in emerg.mode) LEGEND BRIGHTNESS > 2cd/m² JAS PIKTOGRAMU > 2cd/m²
		ENERGY SAVING (in emerg.mode) LEGEND BRIGHTNESS > 2cd/m² JAS PIKTOGRAMU > 2cd/m²
INSTALLATION MODE SET UP		DEFAULT / PREDNASTAVENÉ OFF - ACTIVATED ON - DEACTIVATED
M / NM NON-MAINTAINED / MAINTAINED MODE SET UP		DEFAULT / PREDNASTAVENÉ ON - MAINTAINED OFF - NON-MAINTAINED
AT / ATXL AUTOTEST / CENTRALTEST MODE SET UP		DEFAULT / PREDNASTAVENÉ OFF - AUTOTEST ON - CENTRALTEST
NO AT NO-AUTOTEST MODE SET UP		DEFAULT / PREDNASTAVENÉ OFF - AUTOTEST ACTIVE ON - NO-AUTOTEST

CBS CENTRAL BATTERY VERSIONS

CBS CENTRAL BATTERY	1 LUX ESCAPE ROUTE APPLICATION		FULL POWER PLNY VÝKON
		FULL POWER LEGEND BRIGHTNESS > 200cd/m² JAS PIKTOGRAMU > 200cd/m²	
		ECO MODE 50%	
		ECO MODE 25%	
		ECO MODE 10% LEGEND BRIGHTNESS > 2cd/m² JAS PIKTOGRAMU > 2cd/m²	
L1' INPUT	INPUT L1' FUNCT. SET UP		ONLY FOR CBS VERSIONS ON - +2 BOTTOM LEDs CONTROL OFF - DIMMING
L1' Logic	L1' FUNCT. LOGIC SET UP		ONLY FOR CBS VERSIONS ON - NEGATIVE OFF - POSITIVE

TO SEE THE CHANGE EITHER PUSH THE TEST BUTTON OR DISCONNECT THE FIXTURE FROM BOTH THE MAINS 230V AND BATTERY
Po prestavení stlačte TEST alebo odpojte batériu a pripojenie na sieť na aktiváciu zmeny

INSTALLATION MODE INŠTALAČNÝ MÓD

NORMAL MODE PREVÁDZKOVÝ MÓD

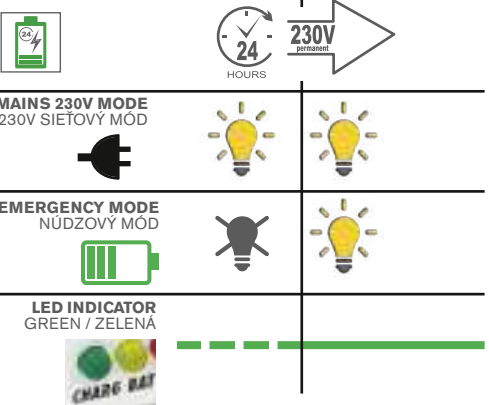

INSTALLATION MODE (green LED is blinking)- Immediately after first connection of Mains 230V, charging of battery starts by constant current 0,05C. The emergency mode is not available unless the battery is fully charged. No mains 230V interruption during 24h can occur. If it occurs the installation mode starts again for another 24h time period = **BATTERY PROTECTION** against daily charging-discharging during a building construction period. After constant 24h mains 230V availability the installation mode ends and **DURATION TEST** starts (for 1h or 3h, yellow LED blinking). After duration test the **NORMAL MODE** starts (green LED lights) and the battery is charged by constant current 0,1C for next 16h. After this 16h time period the charging is switched to **INTERMITTEND CHARGING MODE** (44s charging by 0,1C, 9min no charging = **LONGER BATTERY LIFE TIME** - valid only for fixtures equipped with nimh batteries).

INŠTALAČNÝ MÓD - po prvom pripojení svietidla k sieti 230V sa začne nabíjanie batérie trvalým prúdom 0,05C. Núdzový mód svietidla nie je možné spustiť pokiaľ sa batéria plne nenabije, čo trvá 24h, počas ktorých nesmie prísť k prerušeniu napájania zo siete. Ak je nabíjanie prerušené počas týchto 24hod, inštalačný mód začína plynúť odznova po ďalšom pripojení 230V znovu na dobu 24hod = **OCHRANA BATÉRIE PRED CYKLICKÝM DENNÝM NABÍJANÍM A VYBIJANÍM** po dobu, kým stavba nie je dokončená. Po neprerušenom 24hod nabíjaní batérie inštalačný mód končí a spustí sa **TEST AUTONÓMNOSTI** (1hod alebo 3hod, žltá LED blíkajú). Po teste autonómnosti sa svietidlo prepne automaticky **DO NORMÁLNEHO REŽIMU** (zelená LED svieti) a batéria je nabíjaná ďalších 16hod trvalým prúdom 0,1C. Po tejto perióde je nabíjanie automaticky prepnuté do **INTERMITTEND MÓDU** (44s nabíjanie prúdom 0,1C a 9min bez nabíjania = **PREDLŽUJE ŽIVOTNOSŤ BATÉRIE** - platné len pre svietidlá s nimh batériou).

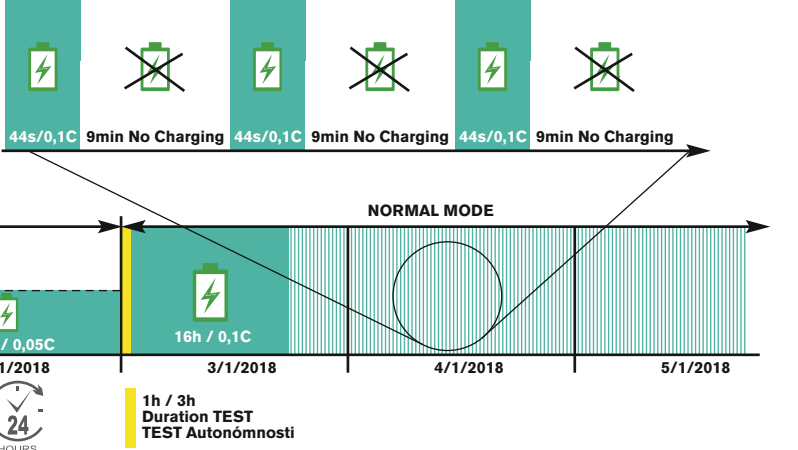

**• EFFICIENT LEDs
>150lm/W**

- Účinné a výkonné LED >150lm/W



All PREMIUM Line emergency lighting fixtures are equipped with the latest MidPower LEDs with the efficiency up to 150lm/W. With the most advanced electronics it makes the fixture high efficient and saves you the operating costs.

Všetky núdzové svietidlá rady PREMIUM sú vybavené MidPower LED s účinnosťou až 150lm/W, čo spolu s pokročilou elektronickou jednotkou robí svietidlo vysoko účinným a znižuje vám prevádzkové náklady.

**• LONGLIFE LEDs
>100.000h**

- Dlhoživotné LED >100000hod



All PREMIUM Line emergency lighting fixtures are equipped with the latest MidPower LEDs with the lifetime more than 100.000h. Thanks to this the service/maintenance costs are very low.

Všetky núdzové svietidlá rady PREMIUM sú vybavené MidPower LED so životnosťou viac ako 100000hod, čo výrazne znižuje potrebné náklady na servis a údržbu.

• LONGLIFE BATTERY

- Dlhoživotná batéria



All PREMIUM Line fixtures are equipped with the LONGLIFE NiMH or LiFePO4 battery. The battery management is ensured by the most advanced electronics which controls all key parameters for charging and discharging.

It saves you the service/maintenance costs.

Všetky núdzové svietidlá rady PREMIUM sú vybavené dlhživotnou NiMH alebo LiFePO4 batériou. Jej manažment je zabezpečený pokročilou elektronikou, ktorá riadi a sleduje všetky hlavné funkcie a parametre nabíjania a vybíjania. Vďaka tomu sú náklady na údržbu a servis veľmi nízke.

• INSTALLATION MODE

- Inštaláčny mód



The installation mode protects the battery after the fixture installation. The emergency mode is blocked until the fixture is connected to the 230V mains min. 24h without any interruption. Thanks to this the frequent battery charging/discharging during the building construction period is eliminated and the battery life time is extended.

Inštaláčny mód je ochranná funkcia, ktorá sa spúšťa automaticky po prvom pripojení svietidla k sieti a nedovoľuje spustenie núdzového módu svietidla skôr, ako je svietidlo pripojené k sieti 230V a tým nabíjaná batéria min. 24hod bez prerušenia. To chráni batériu pred cyklickým denným nabíjaním a vybíjaním najmä ak stavba ešte nie je dokončená. Vďaka tejto funkcii je batéria chránená a predlžuje sa jej životnosť.

• INTELLIGENT CHARGING

- Inteligentné nabíjanie



All PREMIUM Line fixtures are equipped with advanced INTERMITTENT CHARGING method. Thanks to this the battery lifetime is markedly extended and service and maintenance costs are low (valid only for fixtures equipped with NIMH battery).

Všetky núdzové svietidlá rady PREMIUM sú vybavené pokročilou metódou nabíjania akumulátora - prerušované nabíjanie (INTERMITTENT CHARGING), čím je životnosť batérie výrazne predĺžená a náklady na servis a údržbu sú nízke (platí len pre svietidlá vybavené NIMH batériou).

**• ECO MODE
10%-100%**

- ECO mód
10%-100%



The DIP Switch allows you during the fixture installation to preset the different lighting levels for the pictogram illumination during the maintained mode (10%-100%). The illumination of pictogram depends on the ambient light level. If the ambient lighting level is lower then also the fixture power can be lower which allows you to save the energy.

DIP prepínač umožňuje počas inštalácie svietidla prednastaviť požadovú úroveň výkonu pre osvetlenie piktogramu svietidla v normálnom režime na rôzne úrovne (10%-100%) podľa hladiny okolitého osvetlenia. Ak je úroveň okolitého osvetlenia nižšia, tak aj výkon svietidla na osvetlenie piktogramu môže byť nižší a tým sa šetrí elektrická energia.

• ENERGY SAVING MODE

- "Energy saving" mód



The DIP Switch allows you to preset during the fixture installation the different light output levels during emergency mode. Either full power to cover 1x area or to reach illumination of the pictogram with a luminance level of 200cd/m² if it is required or reduced power to illuminate only the pictogram on the level 2cd/m² specified by EN.

Počas inštalácie svietidla umožňuje DIP prepínač prednastaviť požadovaný výkon svietidla v núdzovom režime na rôzne úrovne podľa toho, či je svietidlo určené na osvetlenie únikovej cesty (bez pikto) alebo na dosiahnutie osvetlenia piktogramu na úrovni 200cd/m² alebo len pre osvetlenie piktogramu na úrovni 2cd/m² podľa EN

• POWER FACTOR >0.9

- Power faktor >0,9



All PREMIUM Line emergency lighting fixtures are equipped with the most advanced electronics which achieves the power factor even > 0.9

Všetky núdzové svietidlá rady PREMIUM sú vybavené pokročilou elektronickou jednotkou, ktorá dosahuje úroveň power faktor až >0,9

• DIP SWITCH

- DIP SWITCH



The DIP Switch allows during the fixture installation to preset all: different lighting levels in maintained mode (ECO mode), in emergency mode (ENERGY Saving), INSTALLATION mode ON/OFF, the bottom LEDs activation during the maintained mode (only PRIMALUX and TRENDLUX).

DIP prepínač umožňuje nastaviť počas inštalácie svietidla rôzne úrovne výkonu v normálnom režime (ECO mode), v núdzovom režime (ENERGY Saving), aktiváciu INSTALLATION módu, aktiváciu prídavných LED aj v normálnom režime (len pre PRIMALUX a TRENDLUX).

FEATURES & DIP-SWITCH SET-UP

EVOLUX2

Light source	LED 5000K >500cd/m ² (white luminance) >200cd/m ² (average luminance)
Installed load	5.8W/6.1VA (maintained M) 2.0W/3.9VA (non-maintained NM) 5.7W/6.0VA (CBS)
Protection index	IP40
Viewing distance	28m-39m



Most advanced "V" twin LED light source with perfect light distribution. It is equipped with high efficient (150lm/W) LONGLIFE LEDs with the lifetime min 100.000h

Progresívny svetelný zdroj s perfektnou distribúciou svetla je vybavený dlhoživotnými LED (min 100000 hod) s účinnosťou 150lm/W



Both the mirror-effect >94% reflector shape and body shape ensure perfect lighting characteristics. Thanks to the wide lighting distribution curves you need less SEC emergency lighting fixtures than the standard ones to achieve 1x even emergency lighting illumination level.

Geometria vysokolešteného >94% hliníkového reflektora a telesa svietidla zaručujú dokonalé svetelno-technické parametre svietidla. Vďaka širokej krivke svietivosti je potrebný menší počet svietidiel pre dosiahnutie rovnomerného osvetlenia v porovnaní s bežnými svietidlami.

Perfect Modern Orientated Shape allowing you to use it in all kind of applications

Perfektný tvar telesa svietidla ho predurčuje k použitiu v moderných interiéroch súčasnosti

Linear Fresnel Lens

Lineárna Fresnelova šošovka



AUTOTEST/CENTRALTEST
(only MULTIEVO-AT/ATXL/ATRF):
Monitor status by 3x LEDs and TEST button

AUTOTEST/CENTRALTEST
(In MULTIEVO-AT/ATXL/ATRF)
3x LED pre signalizáciu stavu svetidla
a TEST tlačítko



There are in total 5 cable entries: 4 side ones around the body and 1 from the back side.

Na telese svetidla sa nachádzajú 4x prechodky po obvode svetidla a 1x zo zadnej strany telesa svetidla.



**ENERGY SAVING
ECO MODE
SET UP**



**2/200
cd/m²**

DIP SWITCH FEATURES No.1-4 **DIP PREPÍNAČ č.1-4 - FUNKCIE**
SELF-CONTAINED BATTERY VERSIONS

**NORMAL MODE
230V MAINS**

**EMERGENCY MODE
BATTERY**

**1 LUX
ESCAPE ROUTE
APPLICATION**

**1 LUX
ESCAPE ROUTE
APPLICATION**



NO LEGEND / BEZ PIKTOGRAMU
ESCAPE ROUTE ILLUMINATION

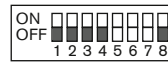

DEFFAULT SETT./ PREDNASTAVENÉ
Full Power for ESCAPE SIGN Applicaton
BRIGHTNESS > 200cd/m²

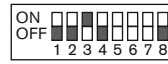

ECO MODE 50% (in 230V mode)
EMERGENCY MODE LEGEND
BRIGHTNESS > 200cd/m²

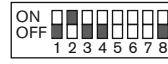

ECO MODE 25% (in 230V mode)
EMERGENCY MODE LEGEND
BRIGHTNESS > 200cd/m²

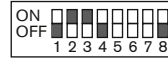

ECO MODE 10% (in 230V mode)
EMERGENCY MODE LEGEND
BRIGHTNESS > 200cd/m²



ENERGY SAVING (in emerg.mode)
LEGEND BRIGHTNESS > 2cd/m²
JAS PIKTOGRAMU > 2cd/m²

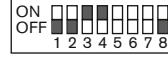

ENERGY SAVING (in emerg.mode)
ECO MODE 50% (in 230V mode)
LEGEND BRIGHTNESS > 2cd/m²

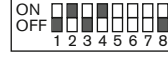

ENERGY SAVING (in emerg.mode)
ECO MODE 25% (in 230V mode)
LEGEND BRIGHTNESS > 2cd/m²

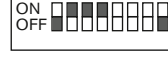

ENERGY SAVING (in emerg.mode)
ECO MODE 10% (in 230V mode)
LEGEND BRIGHTNESS > 2cd/m²



**M /
NM**

**AT /
ATXL**

**NO
AT**

DIP SWITCH FEATURES No.5-8 **DIP PREPÍNAČ č.5-8 - FUNKCIE**



**INSTALLATION
MODE
SET UP**



DEFFAULT SETTING / PREDNASTAVENÉ
OFF - ACTIVATED
ON - DEACTIVATED

**M /
NM**

**NON-MAINTAINED /
MAINTAINED
MODE
SET UP**

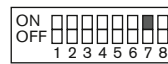

DEFFAULT SETTING / PREDNASTAVENÉ
ON - MAINTAINED
OFF - NON-MAINTAINED

**AT /
ATXL**

**AUTOTEST /
CENTRALTEST
MODE
SET UP**

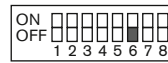

DEFFAULT SETTING / PREDNASTAVENÉ
OFF - AUTOTEST
ON - CENTRALTEST

**NO
AT**

**NO-AUTOTEST
MODE
SET UP**

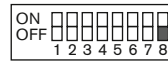

DEFFAULT / PREDNASTAVENÉ
OFF - AUTOTEST ACTIVE
ON - NO-AUTOTEST

TO SEE THE CHANGE PUSH EITHER TEST BUTTON OR DISCONNECT THE FIXTURE FROM BOTH THE MAINS 230V AND BATTERY

Po prestavení stlačte TEST alebo odpojte batériu a 230V napájanie na aktiváciu zmeny

DIP SWITCH FEATURES No.2-3 **DIP PREPÍNAČ č.2-3 - FUNKCIE**
CBS CENTRAL BATTERY VERSIONS

**CBS
CENTRAL BATTERY**

**1 LUX
ESCAPE ROUTE
APPLICATION**



FULL POWER
PLNÝ VÝKON

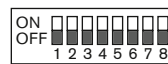

FULL POWER
LEGEND BRIGHTNESS > 200cd/m²
JAS PIKTOGRAMU > 200cd/m²

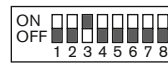

ECO MODE 50%

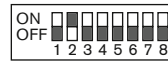

ECO MODE 25%

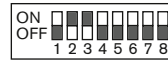

ECO MODE 10%
LEGEND BRIGHTNESS > 2cd/m²
JAS PIKTOGRAMU > 2cd/m²

TO SEE THE CHANGE PUSH EITHER TEST BUTTON OR DISCONNECT THE FIXTURE FROM BOTH THE MAINS 230V AND BATTERY

Po prestavení stlačte TEST alebo odpojte batériu a 230V napájanie na aktiváciu zmeny

FEATURES

EVOLUX2

An elegant design, high efficiency and a pictogram viewing distance range up to 39m - these are the outer features of EVOLUX2 emergency lighting fixture type series. Combined with the qualities of an innovative LED light source - extra-long service life at constant light output - this escape sign luminaire boasts a special talent for low operating costs. The luminaire proves its application flexibility with its range of installation options.

Elegantný design, vysoká účinnosť a rozpoznateľnosť piktogramu až 39m - to sú extra vlastnosti typovej rady EVOLUX2. V kombinácii s kvalitami inovatívneho LED svetelného zdroja - extra dlhá životnosť pri konštantnom svetelnom výkone - sa môže toto núdzové svietidlo pochváliť špeciálnym talentom pre nízke prevádzkové a servisné náklady. EVOLUX2 dokazuje svoju aplikačnú flexibilitu vďaka širokej typovej rade s rôznymi inštaláčnymi možnosťami.

Light source	LED 5000K
	>500cd/m ² (white luminance)
	>200cd/m ² (average luminance)
Installed load	5.8W/6.1VA (maintained M)
	2.0W/3.9VA (non-maintained NM)
	5.7W/6.0VA (CBS)
Protection index	IP40
Viewing distance	28m-39m



Most advanced "V" twin LED light source with perfect light distribution. It is equipped with high efficient (150lm/W) LONGLIFE LEDs with the lifetime min 100.000h



C.EVOLUX2-P LED MULTIEVO2-P-AT LED

brightens escape routes at every step and turn

Wall or ceiling mounting LED emergency luminaire for escape route lighting in accordance with EN1838
Maximum luminaire spacing: up to 14,8m>1lx

LED núdzové svietidlo pre montáž na stenu alebo strop pre osvetlenie únikovej cesty v súlade s EN1838
Maximálny rozstup svietidiel: až 14,8m>1lx



C.EVOLUX2-P LED (with ISO7010 pictogram in AL frame) MULTIEVO2-P-AT LED (with ISO7010 pictogram in AL frame)

escape sign luminaire

LED AL frame legend escape sign emergency luminaire in accordance with EN1838
Legend luminance: >500cd/m² (white)
Viewing distance: 28m

LED núdzové svietidlo s piktogramom v AL rámičku (v súlade s EN1838)
Jas piktogramu: >500cd/m² (biela)
Rozoznateľnosť piktogramu: 28m



C.EVOLUX2-P LED (with self-adhesive picto) MULTIEVO2-P-AT LED (with self-adhesive picto)

escape sign luminaire

LED escape sign emergency luminaire in accordance with EN1838 (self-adhesive pictogram)
Legend luminance: >500cd/m² (white)
Viewing distance: 39m

LED núdzové svietidlo so samolepiacim piktogramom (v súlade s EN1838)
Jas piktogramu: >500cd/m² (biela)
Rozoznateľnosť piktogramu: 39m

**C.EVOLUX2-V LED
MULTIEVO2-V-AT LED**
escape route anti-panic lighting

Recessed mounting LED emergency anti-panic luminaire in accordance with EN1838
Maximum luminaire 1lx spacing: up to 14,8m>1lx
LED núdzové svietidlo pre montáž do stropu pre osvetlenie únikovej cesty v súlade s EN1838
Maximálny rozostup svietidiel na 1lx: až 14,8m>1lx



**C.EVOLUX2-PP LED
MULTIEVO2-PP-AT LED**
escape sign & escape route anti-panic lighting

Ceiling mounting LED emergency anti-panic luminaire in combination with suspended plexi with pictogram in accordance with EN1838
Viewing distance: 34m
Maximum luminaire 1lx spacing: up to 14,8m>1lx
LED núdzové svietidlo pre montáž na strop v kombinácii so závesným plexi s piktogramom pre osvetlenie únikovej cesty v súlade s EN1838
Rozoznatelnosť piktogramu: 34m
Maximálny rozostup svietidiel na 1lx: až 14,8m>1lx



**C.EVOLUX2-PP LED
MULTIEVO2-PP-AT LED**
escape sign with AL frame

Ceiling mounting LED emergency escape sign luminaire with suspended plexi with pictogram in accordance with EN1838
Viewing distance: 34m
LED núdzové svietidlo pre montáž na strop so závesným plexi s piktogramom súlade s EN1838
Rozoznatelnosť piktogramu: 34m



**C.EVOLUX2-VP LED
MULTIEVO2-VP-AT LED**
escape sign & escape route anti-panic lighting

Recessed mounting LED emergency anti-panic luminaire in combination with suspended plexi with pictogram in accordance with EN1838
Viewing distance: 34m
Maximum luminaire 1lx spacing: up to 14,8m>1lx
LED núdzové svietidlo pre montáž do stropu v kombinácii so závesným plexi s piktogramom pre osvetlenie únikovej cesty v súlade s EN1838
Rozoznatelnosť piktogramu: 34m
Maximálny rozostup svietidiel na 1lx: až 14,8m>1lx



**C.EVOLUX2-VP LED
MULTIEVO2-VP-AT LED**
escape sign with AL frame

Recessed mounting LED emergency escape sign luminaire with suspended plexi with pictogram in accordance with EN1838
Viewing distance: 34m
LED núdzové svietidlo pre zapustenú montáž do stropu so závesným plexi s piktogramom súlade s EN1838
Rozoznatelnosť piktogramu: 34m



SURFACE WALL OR CEILING EVOLUX2-P

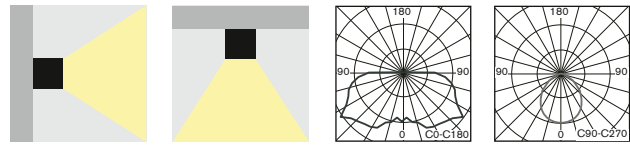

• Euisite design surface mounted powerful LED fixture with perfect light distribution for non-maintained/maintained (NM/M) or centralised (C) emergency lighting available in all following versions:

- **AUTOTEST** (-AT)
- **DALI**
- **CENTRALTEST** (-ATXL) for ELMAX-Look Mini system (look up page No.36)
- **CENTRAL BATTERY** (C.EVOLUX2) for **non-addressable CBS** (look up also page No.44)
- **CENTRAL BATTERY** (-ATXP) for system **ELMAX-PATROLUX Mini & Addressable CBS** (look up also page No.40)
- Conforming to the requirement of EN60598-2-22, EN1838, EN62034
- Design: Anodized AL base & PC impact resistant diffuser

• Elegantné výkonné LED núdzové svietidl s perfektnou distribúciou svetla pre trvalé/netrvalé (NM/M) alebo (C) centrálné napájané núdzové osvetlenie dostupné vo verziách pre:

- **AUTOTEST** (-AT) alebo **DALI**,
- **CENTRALTEST** (-ATXL) pre systém ELMAX-LOOK Mini (pozri str.36)
- **CENTRAL BATTERY** (C.EVOLUX2) pre **neadresovateľné CBS** (str.44)
- **CENTRAL BATTERY** (-ATXP) pre systém **ELMAX-PATROLUX Mini s adresovateľnou CBS** (pozri str. 40)

- spĺňa požiadavky európskej normy EN 60598-2-22, EN1838, EN62034
- konštrukcia: teleso z eloxovaného hliníku a svetelno-činný kryt z nerozbitného PC

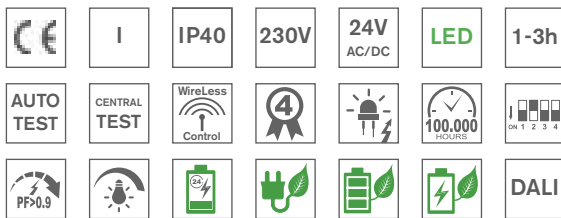

Input Power:

- 5,8W/ 6,1VA (maintained M)
- 2,0W/ 3,9VA (non-maintained NM)
- 5,7W/ 6,0VA (CBS)

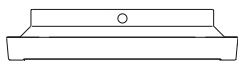
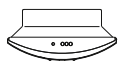

167

350

78

STANDARD FEATURES

STANDARDNÁ VÝBAVA

- **High efficient (150lm/W) LONGLIFE LEDs 5000K (>100.000h)**
- **NEW Advanced Electronics**
- **LONGLIFE LiFePo4 battery**
- **Installation Mode** (battery protection, for more details look up page No.50-51)
- **Intelligent battery charging** (intermittent charging, look up page No.50-51)
- **DIP Switch** allowing to preset following functions:
 - **ECO Mode** (dimming 10%-100%, for more details look up page No.50-51)
 - **ENERGY Saving Mode** (picto illumination 2cd/m² or 200cd/m², look up page 551)
- Special mirror effect reflector
- Addressable CENTRALTEST communication module (for ATXL, ATXP only)
- LEDs indicating both presence of power supply and signaling failures + TEST button
- **vysoko účinné LED 5000K (150lm/W) so životnosťou min.100000h**
- **progressívna elektronická jednotka**
- **LONGLIFE LiFePo4 batéria**
- **Inštaláčny mód** (ochrana batérie, pozri aj str.50-51)
- **Inteligentné nabíjanie batérie** ("intermittent" nabíjanie, pozri aj str.50-51)
- **DIP prepínač** umožňujúci prednastavenie funkcií:
 - **ECO Mód** (stmievanie 10%-100%, pozri aj str.50-51)
 - **ENERGY Saving Mód** (osvetlenie picto na 2cd/m² alebo 200cd/m², pozri aj str.51)
- špeciálny odrazový reflektor so zrkadlovým efektom
- adresovateľný CENTRALTEST komunikačný modul (len pre ATXL, ATXP verzie)
- signalizácia LED a TEST tlačítko

OPTIONAL ACCESSORIES

PRÍPLATKY

- Pictograms / Legends (look up page No.58)
- Wall or ceiling mounting brackets (look up page No.58)
- Protective steel cage (look up page No.58)
- samolepiace alebo fóliové piktogramy s AL rámkom (pozri str.58)
- nástenná, stropná alebo stropná závesná konzola (pozri str.58)
- ochranný kovový kôš (pozri str.58)

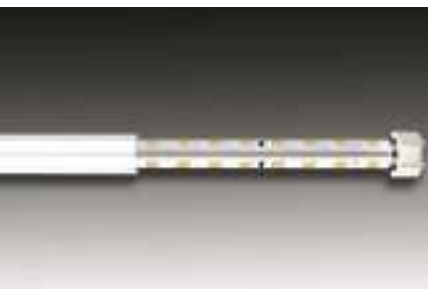

Most Advanced Twin "V" shaped LED light source for perfect light distribution
Progressívny svetelný zdroj s usporiadaním LED do tvaru "V" s perfektnou distribúciou svetla a vysokou účinnosťou



Optional AL Frame with + Foil Legends
Príplatkový AL rámik s piktogramom (look up also page No.58)



Optional Self-adhesive Legends
Príplatkové samolepiace piktogramy (look up also page No.58)



Optional Brackets and Protective Cage
Príplatková kozoly a ochranná mreža (look up also page No.58)

Shopping area emergency lighting application



Page No.32

AUTOTEST -AT NM/M

Type	Version	Duration	Light Source	Light Flux / Emergency mode	Battery	Order Code	Weight
MULTIEVO2-P-AT.1h	NM/M	1h	LED	350 lm / 310 lm	LiFePo4 6,4V/1,0Ah	290-B-001-04-00-00	1,5 kg
MULTIEVO2-P-AT.3h	NM/M	3h	LED	350 lm / 310 lm	LiFePo4 6,4V/2,0Ah	290-B-002-04-00-00	1,6 kg

DALI Self-Contained

Type	Version	Duration	Light Source	Light Flux / Emergency mode	Battery	Order Code	Weight
MULTIEVO2-P-DALI.1h	NM/M	1h	LED	350 lm / 310 lm	LiFePo4 6,4V/1,0Ah	290-B-008-04-00-00	1,7 kg
MULTIEVO2-P-DALI.3h	NM/M	3h	LED	350 lm / 310 lm	LiFePo4 6,4V/2,0Ah	290-B-010-04-00-00	1,7 kg

Page No.36

CENTRALTEST -ATXL ELMAX-LOOK

Type	Version	Duration	Light Source	Light Flux / Emergency mode	Battery	Order Code	Weight
MULTIEVO2-P-ATXL.1h	NM/M	1h	LED	350 lm / 310 lm	LiFePo4 6,4V/1,0Ah	290-B-003-04-00-00	1,6 kg
MULTIEVO2-P-ATXL.3h	NM/M	3h	LED	350 lm / 310 lm	LiFePo4 6,4V/2,0Ah	290-B-004-04-00-00	1,7 kg

Page No.38

CENTRALTEST -ATRF ELMAX-WIRELESS

Type	Version	Duration	Light Source	Light Flux / Emergency mode	Battery	Order Code	Weight
MULTIEVO2-P-ATRF.1h	NM/M	1h	LED	350 lm / 310 lm	LiFePo4 6,4V/1,0Ah	290-B-011-04-00-00	1,6 kg
MULTIEVO2-P-ATRF.3h	NM/M	3h	LED	350 lm / 310 lm	LiFePo4 6,4V/2,0Ah	290-B-009-04-00-00	1,7 kg

DALI CENTRAL BATTERY (CBS)

Type	Version	Light Source	Light Flux	Order Code	Weight
C.EVOLUX2-P DALI 230V AC	DALI CBS	LED	650 lm	290-B-012-00-00-00	1,2 kg

Page No.44

CENTRAL BATTERY (CBS)

Type	Version	Light Source	Light Flux	Order Code	Weight
C.EVOLUX2-P 230V AC/DC	CBS NON-ADDRESSABLE	LED	760 lm	290-B-006-00-00-00	1,2 kg
C.EVOLUX2-P 24V AC/DC	CBS NON-ADDRESSABLE	LED	760 lm	290-B-007-00-00-00	1,2 kg

Page No.40

Addressable CENTRAL BATTERY (CBS) -ATXPR ELMAX-PATROLUX

Type	Version	Light Source	Light Flux	Order Code	Weight
C.EVOLUX2-P-ATXPR 230V AC/DC	ATXPR CBS ADDRESSABLE	LED	760 lm	290-B-005-00-00-00	1,2 kg

Look up pages No. 210-217 for 1lx Spacing tables
Pozri str.210-217 pre rozmiestnenie svetidiel na dosiahnutie 1lx

ACCESSORIES EVOLUX2-P



- Foil based legend + AL cover frame (click system) complying ISO7010
- Viewing Distance: 28m
- Legend luminance > 500cd/m² (white)
- fóliový piktogram + krycí AL rámik („klik“ systém) v súlade s ISO7010
- rozoznatelnosť piktogramu: 28m
- jas piktogramu > 500cd/m² (biela)

Optional Item / Príplatok	Order Code / Objednávaci kód
Foil picto „H“+AL Frame / pikto fólia „H“+rámik	102-B-00-52-01
Foil picto „I“+AL Frame / pikto fólia „I“+rámik	102-B-00-48-01
Foil picto „J“+AL Frame / pikto fólia „J“+rámik	102-B-00-50-01
Foil picto „K“+AL Frame / pikto fólia „K“+rámik	102-B-00-55-01
Foil picto „L“+AL Frame / pikto fólia „L“+rámik	102-B-00-56-01
Foil picto „M“+AL Frame / pikto fólia „M“+rámik	102-B-00-53-01
Foil picto „N“+AL Frame / pikto fólia „N“+rámik	102-B-00-54-01
Foil picto „O“+AL Frame / pikto fólia „O“+rámik	102-B-00-59-01
Foil picto „Z1“+AL Frame / pikto fólia „Z1“+rámik	102-B-00-70-00
Foil picto „Z2“+AL Frame / pikto fólia „Z2“+rámik	102-B-00-71-00



- Self-adhesive legend complying ISO7010
- Viewing Distance 39m
- Legend luminance > 500cd/m² (white)
- samolepiaci piktogram v súlade s ISO7010
- rozoznatelnosť piktogramu 39m
- jas piktogramu > 500cd/m² (biela)

Optional Item / Príplatok	Order Code / objednávaci kód
Self-adhesive „H“ / samolepiaci piktogram „H“	V-102-SAM-01-00-04
Self-adhesive „I“ / samolepiaci piktogram „I“	V-102-SAM-01-00-05
Self-adhesive „J“ / samolepiaci piktogram „J“	V-102-SAM-01-00-06
Self-adhesive „O“ / samolepiaci piktogram „O“	V-102-SAM-01-00-92
Self-adhesive „Z1“ / samolepiaci piktogram „Z1“	V-102-SAM-01-00-136
Self-adhesive „Z2“ / samolepiaci piktogram „Z2“	V-102-SAM-01-00-36



Options:

- Wall / Ceiling / Pendant mounting bracket
- Protective Steel Cage

Príplatky:

- nástenná / stropná / závesná konzola
- ochranný kôš

Optional Item / Príplatok	Order Code / objednávaci kód
Wall mounting bracket / nástenná konzola	102-B-01-09-01
Ceiling mounting bracket / stropná konzola	102-B-01-08-01
Pendant bracket 0,5m / závesná konzola 0,5m	102-B-28-02-00
Pendant bracket 1,0m / závesná konzola 1,0m	102-B-28-03-00
Pendant bracket 1,5m / závesná konzola 1,5m	102-B-28-04-00
Protective steel cage / ochranný kôš	102-B-00-29-00

Shopping area emergency lighting application



CEILING MOUNTING READY FOR SUSPENDED LEGEND EVOLUX2-PP

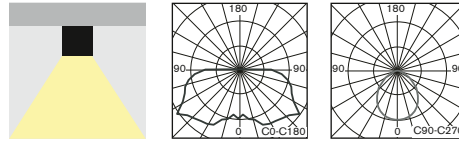

- Equisite design surface mounted powerful LED fixture with perfect light distribution ready for suspended plexi legend
- Designed for non-maintained/maintained (NM/M) or centralised (C) emergency lighting available in all following versions:

- **AUTOTEST** (-AT)
- **DALI**
- **CENTRALTEST** (-ATXL) for ELMAX-Look Mini system (look up page No.36)
- **CENTRAL BATTERY** (C.EVOLUX2) for **non-addressable CBS** (page 44)
- **CENTRAL BATTERY** (-ATXP) for system **ELMAX-PATROLUX Mini & Addressable CBS** (look up page No. 40)
- Conforming to the requirement of EN60598-2-22, EN1838, EN62034
- Design: Anodized AL base & PC impact resistant diffuser

- Elegánntné výkonné LED núdzové svietidlo s perfektnou distribúciou svetla pre trvalé/netrvalé (NM/M) alebo (C) centrálné napájané núdzové osvetlenie dostupné vo verziách pre:

- **AUTOTEST** (-AT)
- **DALI**
- **CENTRALTEST** (-ATXL) pre systém ELMAX-LOOK Mini (pozri str.36)
- **CENTRAL BATTERY** (C.EVOLUX2) pre **neadresovateľné CBS** (str. 44)
- **CENTRAL BATTERY** (-ATXP) pre systém **ELMAX-PATROLUX Mini s adresovateľnou CBS** (pozri str. 40)

- spĺňa požiadavky európskej normy EN 60598-2-22, EN1838, EN62034
- konštrukcia: teleso z eloxovaného hliníku a svetelno-činný kryt z nerozbitného PC

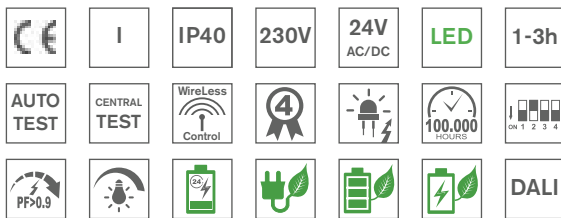

Input Power:

- 5,8W/ 6,1VA (maintained M)
- 2,0W/ 3,9VA (non-maintained NM)
- 5,7W/ 6,0VA (CBS)

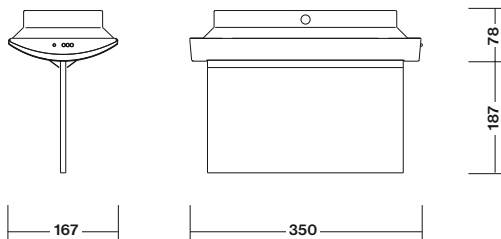

STANDARD FEATURES

STANDARDNÁ VÝBAVA

- **High efficient (150lm/W) LONGLIFE LEDs 5000K (>100.000h)**
- **NEW Advanced Electronics**
- **LONGLIFE LiFePo4 battery**
- **Installation Mode** (battery protection, for more details look up page No.50-51)
- **Intelligent battery charging** (intermittent charging, look up page No.50-51)
- **DIP Switch** allowing to preset following functions:
 - **ECO Mode** (dimming 10%-100%, for more details look up page No.50-51)
 - **ENERGY Saving Mode** (picto illumination 2cd/m² or 200cd/m², look up page 51)
- Special mirror effect reflector
- Addressable CENTRALTEST communication module (for ATXL, ATXP only)
- LEDs indicating both presence of power supply and signaling failures & TEST button
- **vysoko účinné LED 5000K (150lm/W) so životnosťou min.100000h**
- **progressívna elektronická jednotka**
- **LONGLIFE LiFePo4 batéria**
- **Inštalčný mód** (ochrana batérie, pozri aj str.50-51)
- **Inteligentné nabíjanie batérie** ("intermittent" nabíjanie, pozri aj str.50-51)
- **DIP prepínač** umožňujúci prednastavenie funkcií:
 - **ECO Mód** (stmievanie 10%-100%, pozri aj str.50-51)
 - **ENERGY Saving Mód** (osvetlenie piko na 2cd/m² alebo 200cd/m², pozri aj str.51)
- špeciálny odrazový reflektor so zrkadlovým efektom
- adresovateľný CENTRALTEST komunikačný modul (len pre ATXL, ATXP verzie)
- signalizácia LED a TEST tlačítko

OPTIONAL ACCESSORIES

PRÍPLATKY

- Suspended plexi with double sided or single sided legends (look up page No.64)
- Suspended mounting ceiling brackets (look up page No.64)
- AL cover frame for light beam direction to the plexi with legend (look up page No.64)
- závesné plexi s jednostranným alebo obojstranným piktogramom (pozri str.64)
- stropná závesná konzola (pozri str.64)
- hliníkový rámik pre nasmerovanie svetla len do plexi hrany (pozri str.64)



Most Advanced Twin "V" shaped LED light source for perfect light distribution and high efficiency
Progressívny svetelný zdroj s usporiadaním LED do tvaru "V" s perfektnou distribúciou svetla a vysokou účinnosťou



Optional Suspended Plexi Legends and AL Frame
Príplatkové závesné plexi s piktogramom a AL rámik (look up also page No.64)



Optional Brackets
Príplatkové konzoly (look up also page No.64)

CEILING MOUNTING READY FOR SUSPENDED LEGEND
EVOLUX2-PP

Shopping area emergency lighting application



Page No.32

AUTOTEST -AT NM/M

Type	Version	Duration	Light Source	Light Flux / Emergency mode	Battery	Order Code	Weight
MULTIEVO2-PP-AT.1h	NM/M	1h	LED	350 lm / 310 lm	LiFePo4 6,4V/1,0Ah	290-B-100-04-00-00	1,5 kg
MULTIEVO2-PP-AT.3h	NM/M	3h	LED	350 lm / 310 lm	LiFePo4 6,4V/2,0Ah	290-B-101-04-00-00	1,6 kg

DALI Self-Contained

Type	Version	Duration	Light Source	Light Flux / Emergency mode	Battery	Order Code	Weight
MULTIEVO2-PP-DALI.1h	NM/M	1h	LED	350 lm / 310 lm	LiFePo4 6,4V/1,0Ah	290-B-108-04-00-00	1,7 kg
MULTIEVO2-PP-DALI.3h	NM/M	3h	LED	350 lm / 310 lm	LiFePo4 6,4V/2,0Ah	290-B-109-04-00-00	1,7 kg

Page No.36

CENTRALTEST -ATXL ELMAX-LOOK

Type	Version	Duration	Light Source	Light Flux / Emergency mode	Battery	Order Code	Weight
MULTIEVO2-PP-ATXL.1h	NM/M	1h	LED	350 lm / 310 lm	LiFePo4 6,4V/1,0Ah	290-B-102-04-00-00	1,6 kg
MULTIEVO2-PP-ATXL.3h	NM/M	3h	LED	350 lm / 310 lm	LiFePo4 6,4V/2,0Ah	290-B-103-04-00-00	1,7 kg

Page No.38

CENTRALTEST -ATRF ELMAX-WIRELESS

Type	Version	Duration	Light Source	Light Flux / Emergency mode	Battery	Order Code	Weight
MULTIEVO2-PP-ATRF.1h	NM/M	1h	LED	350 lm / 310 lm	LiFePo4 6,4V/1,0Ah	290-B-110-04-00-00	1,6 kg
MULTIEVO2-PP-ATRF.3h	NM/M	3h	LED	350 lm / 310 lm	LiFePo4 6,4V/2,0Ah	290-B-111-04-00-00	1,7 kg

DALI CENTRAL BATTERY (CBS)

Type	Version	Light Source	Light Flux	Order Code	Weight
C.EVOLUX2-P DALI 230V AC	DALI CBS	LED	650 lm	290-B-105-00-00-00	1,2 kg

Page No.44

CENTRAL BATTERY (CBS)

Type	Version	Light Source	Light Flux	Order Code	Weight
C.EVOLUX2-PP 230V AC/DC	CBS NON-ADDRESSABLE	LED	760 lm	290-B-106-00-00-00	1,2 kg
C.EVOLUX2-PP 24V AC/DC	CBS NON-ADDRESSABLE	LED	760 lm	290-B-107-00-00-00	1,2 kg

Page No.40

Addressable CENTRAL BATTERY (CBS) -ATXPR ELMAX-PATROLUX

Type	Version	Light Source	Light Flux	Order Code	Weight
C.EVOLUX2-PP-ATXPR 230V AC/DC	ATXPR CBS ADDRESSABLE	LED	760 lm	290-B-104-00-00-00	1,2 kg

Look up pages No. 210-217 for 1lx Spacing tables
 Pozri str.210-217 pre rozmiestnenie svetidiel na dosiahnutie 1lx

EVOLUX2-VP

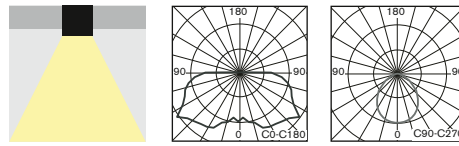

- Equisite design recessed mounted powerful LED fixture with perfect light distribution ready for suspended plexi legend
- Designed for non-maintained/maintained (NM/M) or centralised (C) emergency lighting available in all following versions:
 - **AUTOTEST** (-AT)
 - **DALI**
 - **CENTRALTEST** (-ATXL) for ELMAX-Look Mini system (look up also page 36)
 - **CENTRAL BATTERY** (C.EVOLUX2) for **non-addressable CBS** (page 44)
 - **CENTRAL BATTERY** (-ATXP) for system **ELMAX-PATROLUX Mini & Addressable CBS** (look up also page No.40)
- Conforming to the requirement of EN60598-2-22, EN1838, EN62034
- Design: Anodized AL base & PC impact resistant diffuser
- Elegánntné výkonné LED núdzové svietidlo s perfektnou distribúciou svetla pre trvalé/netrvalé (NM/M) alebo (C) centrálné napájané núdzové osvetlenie dostupné vo verziách pre:
 - **AUTOTEST** (-AT)
 - **DALI**
 - **CENTRALTEST** (-ATXL) pre systém ELMAX-LOOK Mini (pozri str.36)
 - **CENTRAL BATTERY** (C.EVOLUX2) pre **neadresovateľné CBS** (str. 44)
 - **CENTRAL BATTERY** (-ATXP) pre systém **ELMAX-PATROLUX Mini s adresovateľnou CBS** (pozri str. 40)
- spĺňa požiadavky európskej normy EN 60598-2-22, EN1838, EN62034
- konštrukcia: teleso z eloxovaného hliníku a svetelno-činný kryt z nerozbitného PC

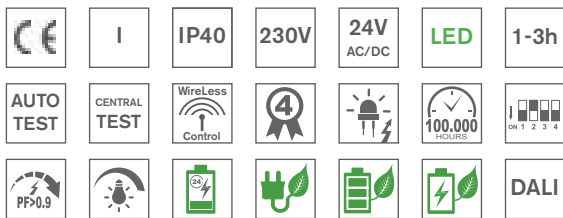

Input Power:

- 5,8W/ 6,1VA (maintained M)
- 2,0W/ 3,9VA (non-maintained NM)
- 5,7W/ 6,0VA (CBS)



Recessed hole size 319x123mm
Rozmer montážneho otvoru 319x123mm

STANDARD FEATURES

STANDARDNÁ VÝBAVA

- **High efficient (150lm/W) LONGLIFE LEDs 5000K (>100.000h)**
- **NEW Advanced Electronics**
- **LONGLIFE LiFePo4 battery**
- **Installation Mode** (battery protection, for more details look up page No.50-51)
- **Intelligent battery charging** (intermittent charging, look up page No.50-51)
- **DIP Switch** allowing to preset following functions:
 - **ECO Mode** (dimming 10%-100%, for more details look up page No.50-51)
 - **ENERGY Saving Mode** (picto illumination 2cd/m² or 200cd/m², look up page 51)
- Special mirror effect reflector
- Addressable CENTRALTEST communication module (for ATXL, ATXP only)
- LEDs indicating both presence of power supply and signaling failures & TEST button
- **vysoko účinné LED 5000K (150lm/W) so životnosťou min.100000h**
- **progresívna elektronická jednotka**
- **LONGLIFE LiFePo4 batéria**
- **Inštalacný mód** (ochrana batérie, pozri aj str.50-51)
- **Inteligentné nabíjanie batérie** ("intermittent" nabíjanie, pozri aj str.50-51)
- **DIP prepínač** umožňujúci prednastavenie funkcií:
 - **ECO Mód** (stmievanie 10%-100%, pozri aj str.50-51)
 - **ENERGY Saving Mód** (osvetlenie pikto na 2cd/m² alebo 200cd/m², pozri aj str.51)
- špeciálny odrazový reflektor so zrkadlovým efektom
- adresovateľný CENTRALTEST komunikačný modul (len pre ATXL, ATXP verzie)
- signalizácia LED a TEST tlačítko

OPTIONAL ACCESSORIES

PRÍPLATKY

- Suspended plexi with double sided or single sided legends (look up page No.64)
- Suspended mounting ceiling brackets (look up page No.64)
- AL cover frame for light beam direction to the plexi with legend (look up page No.64)
- závesné plexi s jednostranným alebo obojstranným piktogramom (pozri str.64)
- stropná závesná konzola (pozri str.64)
- hliníkový rámik pre nasmerovanie svetla len do plexi hrany (pozri str.64)



Most Advanced Twin "V" shaped LED light source for perfect light distribution and high efficiency
Progresívny svetelný zdroj s usporiadaním LED do tvaru "V" s perfektnou distribúciou svetla a vysokou účinnosťou



Optional Suspended Plexi with Legends
Príplatkové závesné plexi s piktogramom (look up also page No.64)



Optional AL cover
Príplatkový hliníkový kryt (look up also page No.64)

RECESSED MOUNTING READY FOR SUSPENDED LEGEND
EVOLUX2-VP

Shopping area emergency lighting application



Page No.32

AUTOTEST -AT NM/M

Type	Version	Duration	Light Source	Light Flux / Emergency mode	Battery	Order Code	Weight
MULTIEVO2-VP-AT.1h	NM/M	1h	LED	350 lm / 310 lm	LiFePo4 6,4V/1,0Ah	290-B-300-04-00-00	1,5 kg
MULTIEVO2-VP-AT.3h	NM/M	3h	LED	350 lm / 310 lm	LiFePo4 6,4V/2,0Ah	290-B-301-04-00-00	1,6 kg

DALI Self-Contained

Type	Version	Duration	Light Source	Light Flux / Emergency mode	Battery	Order Code	Weight
MULTIEVO2-VP-DALI.1h	NM/M	1h	LED	350 lm / 310 lm	LiFePo4 6,4V/1,0Ah	290-B-308-04-00-00	1,5 kg
MULTIEVO2-VP-DALI.3h	NM/M	3h	LED	350 lm / 310 lm	LiFePo4 6,4V/2,0Ah	290-B-309-04-00-00	1,5 kg

Page No.36

CENTRALTEST -ATXL ELMAX-LOOK

Type	Version	Duration	Light Source	Light Flux / Emergency mode	Battery	Order Code	Weight
MULTIEVO2-VP-ATXL.1h	NM/M	1h	LED	350 lm / 310 lm	LiFePo4 6,4V/1,0Ah	290-B-302-04-00-00	1,6 kg
MULTIEVO2-VP-ATXL.3h	NM/M	3h	LED	350 lm / 310 lm	LiFePo4 6,4V/2,0Ah	290-B-303-04-00-00	1,7 kg

Page No.38

CENTRALTEST -ATRF ELMAX-WIRELESS

Type	Version	Duration	Light Source	Light Flux / Emergency mode	Battery	Order Code	Weight
MULTIEVO2-VP-ATRF.1h	NM/M	1h	LED	350 lm / 310 lm	LiFePo4 6,4V/1,0Ah	290-B-310-04-00-00	1,6 kg
MULTIEVO2-VP-ATRF.3h	NM/M	3h	LED	350 lm / 310 lm	LiFePo4 6,4V/2,0Ah	290-B-311-04-00-00	1,7 kg

DALI CENTRAL BATTERY (CBS)

Type	Version	Light Source	Light Flux	Order Code	Weight
C.EVOLUX2-VP DALI 230V AC	DALI CBS	LED	650 lm	290-B-305-00-00-00	1,2 kg

Page No.44

CENTRAL BATTERY (CBS)

Type	Version	Light Source	Light Flux	Order Code	Weight
C.EVOLUX2-VP 230V AC/DC	CBS NON-ADDRESSABLE	LED	760 lm	290-B-306-00-00-00	1,2 kg
C.EVOLUX2-VP 24V AC/DC	CBS NON-ADDRESSABLE	LED	760 lm	290-B-307-00-00-00	1,2 kg

Page No.40

Addressable CENTRAL BATTERY (CBS) -ATXPR ELMAX-PATROLUX

Type	Version	Light Source	Light Flux	Order Code	Weight
C.EVOLUX2-VP-ATXPR 230V AC/DC	ATXPR CBS ADDRESSABLE	LED	760 lm	290-B-304-00-00-00	1,2 kg

Look up pages No. 210-217 for 1x Spacing tables
 Pozri str.210-217 pre rozmiestnenie svetidiel na dosiahnutie 1x



- Suspended plexi with single or double sided legend complying ISO7010
- Viewing Distance: 34m
- AL cover frame for light beam direction to the plexi with legend
- závesné plexi s jednostranným alebo obojstranným piktogramom podľa ISO7010
- rozoznatelnosť piktogramu: 34m
- hliníkový krycí rámik pre nasmerovanie svetla len do plexi strany

Optional Item / Príplatok	Order Code / Objednávaci kód
Suspended plexi H/J doublesided / obojstranné	102-B-08-11-01
Suspended plexi I doublesided / obojstranné	102-B-08-10-01
Suspended plexi H singlesided / jednostranné	102-B-08-50-00
Suspended plexi I singlesided / jednostranné	102-B-08-51-00
Suspended plexi J singlesided / jednostranné	102-B-08-52-00
Suspended plexi O singlesided / jednostranné	102-B-08-49-00
Suspended plexi O doublesided / obojstranné	102-B-08-47-00
Suspended plexi K/M doublesided / obojstranné	102-B-08-41-01
Suspended plexi L/N doublesided / obojstranné	102-B-08-42-01
Suspended plexi K singlesided / jednostranné	102-B-08-53-00
Suspended plexi L singlesided / jednostranné	102-B-08-54-00
Suspended plexi M singlesided / jednostranné	102-B-08-55-00
Suspended plexi N singlesided / jednostranné	102-B-08-56-00
Suspended plexi Z1 singlesided / jednostranné	102-B-00-57-00
Suspended plexi Z1 doublesided / obojstranné	102-B-00-58-00
Suspended plexi Z2 singlesided / jednostranné	102-B-00-59-00
Suspended plexi Z2 doublesided / obojstranné	102-B-00-60-00
AL cover frame / krycí rámik	102-B-00-27-00

**Options:**

- Wall /Pendant mounting bracket

Príplatky:

- nástenná / závesná konzola

Optional Item Príplatok	Order Code Objednávaci kód
Wall mounting bracket / nástenná konzola RAL9003	102-B-01-09-01
Ceiling mounting bracket / stropná konzola RAL9003	102-B-01-08-01
Pendant bracket 0,5m / závesná konzola 0,5m RAL9003	102-B-28-02-00
Pendant bracket 0,7m / závesná konzola 0,7m RAL9003	102-B-28-05-00
Pendant bracket 0,7m / závesná konzola 0,7m RAL9006	102-B-28-05-01
Pendant bracket 0,75m / závesná konzola 0,75m RAL9006	102-B-28-08-00
Pendant bracket 1,0m / závesná konzola 1,0m RAL9003	102-B-28-03-00
Pendant bracket 1,5m / závesná konzola 1,5m RAL9003	102-B-28-04-00
Pendant bracket 2,25m /závesná konzola 2,25m RAL9003	102-B-28-07-00
Pendant bracket 2,75m /závesná konzola 2,75m RAL9006	102-B-28-11-00
Pendant bracket 3m /závesná konzola 3m RAL9006	102-B-28-10-00
Pendant bracket 3,5m /závesná konzola 3,5m RAL9006	102-B-28-12-00

Shopping area emergency lighting application



RECESSED MOUNTING EVOLUX2-V

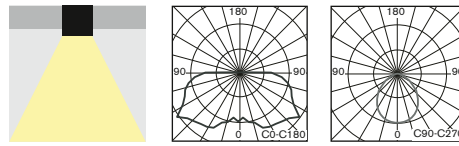

- Equisite design recessed mounted powerful LED fixture with perfect light distribution
- Designed for non-maintained/maintained (NM/M) or centralised (C) emergency lighting available in all following versions:
 - **AUTOTEST** (-AT)
 - **DALI**
 - **CENTRALTEST** (-ATXL) for ELMAX-Look Mini system (look up page No.36)
 - **Wireless CENTRALTEST** (-ATRF) for ELMAX-ATRF system (page No.38)
 - **CENTRAL BATTERY** (C.EVOLUX2) for **non-addressable CBS** (page 44)
 - **CENTRAL BATTERY** (-ATXP) for system **ELMAX-PATROLUX Mini & Addressable CBS** (look up also page No.40)
- Conforming to the requirement of EN60598-2-22, EN1838, EN62034
- Design:
 - Anodized AL base
 - PC impact resistant diffuser
- Elegantné výkonné LED núdzové svietidlo s perfektnou distribúciou svetla pre trvalé/netrvalé (NM/M) alebo (C) centrálné napájané núdzové osvetlenie dostupné vo verziách pre:
 - **AUTOTEST** (-AT)
 - **DALI**
 - **CENTRALTEST** (-ATXL) pre systém ELMAX-LOOK Mini (pozri str.36)
 - **bezdrôtový CENTRALTEST** (-ATRF) pre ELMAX-ATRF systém (str.38)
 - **CENTRAL BATTERY** (C.EVOLUX2) pre **neadresovateľné CBS** (str.44)
 - **CENTRAL BATTERY** (-ATXP) pre systém **ELMAX-PATROLUX Mini s adresovateľnou CBS** (pozri str.40)
- spĺňa požiadavky európskej normy EN 60598-2-22, EN1838, EN62034
- konštrukcia:
 - teleso z eloxovaného hliníku
 - svetelno-činný kryt z nerozbitného PC

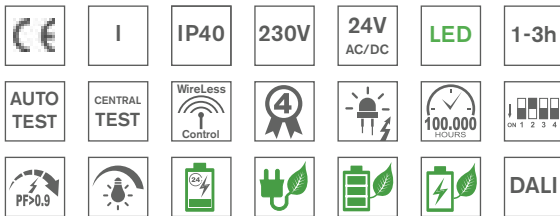

Input Power:

- 5,8W/ 6,1VA (maintained M)
- 2,0W/ 3,9VA (non-maintained NM)
- 5,7W/ 6,0VA (CBS)

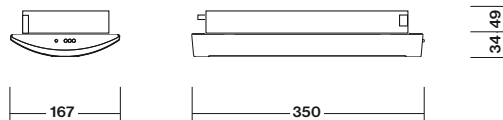

Recessed hole size 319x123mm
Rozmer montážneho otvoru 319x123mm

Most Advanced Twin "V" shaped LED light source for perfect light distribution and high efficiency

Progresívny svetelný zdroj s usporiadaním LED do tvaru "V" s perfektnou distribúciou svetla a vysokou účinnosťou



STANDARD FEATURES

STANDARDNÁ VÝBAVA

- **High efficient (150lm/W) LONGLIFE LEDs 5000K (>100.000h)**
- **NEW Advanced Electronics**
- **LONGLIFE NiMh or LiFePo4 battery**
- **Installation Mode** (battery protection, for more details look up page No.50-51)
- **Intelligent battery charging** (intermittent charging, look up page No.50-51)
- **DIP Switch** allowing to preset following functions:
 - **ECO Mode** (dimming 10%-100%, for more details look up page No.50-51)
 - **ENERGY Saving Mode** (picto illumination 2cd/m² or 200cd/m², look up page No.50-51)
- Special mirror effect reflector
- Addressable CENTRALTEST communication module (for ATXL, ATXP only)
- LEDs indicating both presence of power supply and signaling failures
- TEST button
- **vysoko účinné LED 5000K (150lm/W) so životnosťou min.100000h**
- **progresívna elektronická jednotka**
- **LONGLIFE NiMh alebo LiFePo4 batéria**
- **Inštalčný mód** (ochrana batérie, pozri aj str.50-51)
- **Inteligentné nabíjanie batérie** ("intermittent" nabíjanie, pozri aj str.50-51)
- **DIP prepínač** umožňujúci prednastavenie funkcií:
 - **ECO Mód** (stmievanie 10%-100%, for more details look up page No.50-51)
 - **ENERGY Saving Mód** (osvetlenie pikto na 2cd/m² alebo 200cd/m², pozri aj str.50-51)
- špeciálny odrazový reflektor so zrkadlovým efektom
- adresovateľný CENTRALTEST komunikačný modul (len pre ATXL, ATXP verzie)
- signalizácia LED a TEST tlačítko



Page No.32

AUTOTEST -AT NM/M

Type	Version	Duration	Light Source	Light Flux / Emergency mode	Battery	Order Code	Weight
MULTIEVO2-V-AT.1h	NM/M	1h	LED	350 lm / 310 lm	LiFePo4 6,4V/1,0Ah	290-B-200-04-00-00	1,5 kg
MULTIEVO2-V-AT.3h	NM/M	3h	LED	350 lm / 310 lm	LiFePo4 6,4V/2,0Ah	290-B-201-04-00-00	1,6 kg

DALI Self-Contained

Type	Version	Duration	Light Source	Light Flux / Emergency mode	Battery	Order Code	Weight
MULTIEVO2-V-DALI.1h	NM/M	1h	LED	350 lm / 310 lm	LiFePo4 6,4V/1,0Ah	290-B-208-04-00-00	1,5 kg
MULTIEVO2-V-DALI.3h	NM/M	3h	LED	350 lm / 310 lm	LiFePo4 6,4V/2,0Ah	290-B-209-04-00-00	1,5 kg

Page No.36

CENTRALTEST -ATXL ELMAX-LOOK

Type	Version	Duration	Light Source	Light Flux / Emergency mode	Battery	Order Code	Weight
MULTIEVO2-V-ATXL.1h	NM/M	1h	LED	350 lm / 310 lm	LiFePo4 6,4V/1,0Ah	290-B-202-04-00-00	1,6 kg
MULTIEVO2-V-ATXL.3h	NM/M	3h	LED	350 lm / 310 lm	LiFePo4 6,4V/2,0Ah	290-B-203-04-00-00	1,7 kg

Page No.38

CENTRALTEST -ATRF ELMAX-WIRELESS

Type	Version	Duration	Light Source	Light Flux / Emergency mode	Battery	Order Code	Weight
MULTIEVO2-V-ATRF.1h	NM/M	1h	LED	350 lm / 310 lm	LiFePo4 6,4V/1,0Ah	290-B-210-04-00-00	1,6 kg
MULTIEVO2-V-ATRF.3h	NM/M	3h	LED	350 lm / 310 lm	LiFePo4 6,4V/2,0Ah	290-B-211-04-00-00	1,7 kg

DALI CENTRAL BATTERY (CBS)

Type	Version	Light Source	Light Flux	Order Code	Weight
C.EVOLUX2-V DALI 230V AC	DALI CBS	LED	650 lm	290-B-205-04-00-00	1,2 kg

Page No.44

CENTRAL BATTERY (CBS)

Type	Version	Light Source	Light Flux	Order Code	Weight
C.EVOLUX2-V 230V AC/DC	CBS NON-ADDRESSABLE	LED	760 lm	290-B-206-00-00-00	1,2 kg
C.EVOLUX2-V 24V AC/DC	CBS NON-ADDRESSABLE	LED	760 lm	290-B-207-00-00-00	1,2 kg

Page No.40

Addressable CENTRAL BATTERY (CBS) -ATXPR ELMAX-PATROLUX

Type	Version	Light Source	Light Flux	Order Code	Weight
C.EVOLUX2-V-ATXPR 230V AC/DC	ATXPR CBS ADDRESSABLE	LED	760 lm	290-B-204-00-00-00	1,2 kg

Look up pages No. 210-217 for 1lx Spacing tables
Pozri str.210-217 pre rozmiestnenie svietidiel na dosiahnutie 1lx

DESIGN FEATURES

TRENDLUX2



Most advanced "V" twin LED light source with perfect light distribution. It is equipped with high efficient (150lm/W) **LONGLIFE** LEDs with the lifetime min 100.000h

Modern IK10 impact resistant design based on high quality polycarbonate housing which enhances the functional aspects of TRENDLUX type serie which can be used either in any office or industry application. Combined with the qualities of an innovative LED light source (extra-long service life at constant light output) this escape sign luminaire boasts a special talent for low operating costs.

Moderný nadčasový design vychádzajúci z kvalitného materiálu telesa svietidla - PC polykarbonát, ktorý ešte viac znásobuje funkčné vlastnosti a možnosti použitia svietidiel typovej rady TRENDLUX od "office" až po "industry" IK10 aplikácie. V kombinácii s kvalitami inovatívneho LED svetelného zdroja (extra dlhá životnosť pri konštantnom svetelnom výkone) sa môže toto núdzové svietidlo pochváliť špeciálnym talentom pre nízke prevádzkové a servisné náklady.

 **Lux
Design**



Additional 2pcs of Power LEDs which arrange perfect light distribution downward in order to get more light on the floor for wall mounting version. Or in case of legend on the diffuser the additional LEDs will arrange enough light level on the floor below the fixture.

Pridavné 2 výkonné LED, ktoré zabezpečujú výkonné osvetlenie podlahy v prípade montáže na stenu, čo môže byť s výhodou použité aj v kombinácii s piktogramom. Tri LED nasvetia piktogram, spodné 2 LED zabezpečia nasvetlenie únikovej cesty na dosiahnutie 1lx.

AUTOTEST/CENTRALTEST
Monitor status by 3x LEDs
and TEST button

AUTOTEST/CENTRALTEST
3x LED pre signalizáciu stavu
svietidla a TEST tlačítko

There are in total 6 cable entries:
4 side ones around the body
and 2 from the back side.

Na telese svietidla sa nachádzajú 4 prechodky po obvode svietidla a 2 zo zadnej strany telesa svietidla.

DESIGN FEATURES TRENDLUX2



Light source	LED 5000K >500cd/m ² (white luminance) >200cd/m ² (average luminance)
Installed load	5.8W/6.1VA (maintained M) 2.0W/3.9VA (non-maintained NM) 6.3W/6.5VA (CBS)
Protection type	IP65 IK10
Housing material	Impact resistant polycarbonate
Viewing distance	35m
Application	Escape route lighting
Max luminaire spacing	up to 12,7m > 1lx



**ENERGY SAVING
ECO MODE
SET UP**



**2/200
cd/m²**

**NO
AT**

DIP SWITCH FEATURES No.1-8 / DIP PŘEPÍNAČ č.1-8 - FUNKCIE

SELF-CONTAINED BATTERY VERSIONS

NORMAL MODE 230V MAINS

EMERGENCY BATTERY MODE

**+2xLED
BOTTOM LEDs
ACTIVATION**



+2xBOTTOM LEDs ACTIVATION in 230V
ON - ACTIVATED
OFF - DEACTIVATED



DEFAULT SETT./ PREDNASTAVENÉ
Full Power



ECO MODE 50% (in 230V mode)
EMERGENCY MODE LEGEND
BRIGHTNESS > 200cd/m²



ECO MODE 25% (in 230V mode)
EMERGENCY MODE LEGEND
BRIGHTNESS > 200cd/m²



ECO MODE 10% (in 230V mode)
EMERGENCY MODE LEGEND
BRIGHTNESS > 200cd/m²



ENERGY SAVING (in emerg.mode)
LEGEND BRIGHTNESS > 2cd/m²
JAS PIKTOGRAMU > 2cd/m²



ENERGY SAVING (in emerg.mode)
ECO MODE 50% (in 230V mode)
LEGEND BRIGHTNESS > 2cd/m²



ENERGY SAVING (in emerg.mode)
ECO MODE 25% (in 230V mode)
LEGEND BRIGHTNESS > 2cd/m²



**INSTALLATION
MODE
SET UP**



DEFAULT / PREDNASTAVENÉ
OFF - ACTIVATED
ON - DEACTIVATED



**M /
NM**
NON-MAINTAINED /
MAINTAINED
MODE
SET UP



DEFAULT / PREDNASTAVENÉ
ON - MAINTAINED
OFF - NON-MAINTAINED



**AT /
ATXL**
AUTOTEST /
CENTRALTEST
MODE
SET UP



DEFAULT / PREDNASTAVENÉ
OFF - AUTOTEST
ON - CENTRALTEST



**NO
AT**
NO-AUTOTEST
MODE
SET UP

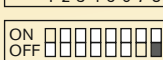

DEFAULT / PREDNASTAVENÉ
OFF - AUTOTEST ACTIVE
ON - NO-AUTOTEST

CBS CENTRAL BATTERY VERSIONS

CBS CENTRAL BATTERY

**1 LUX
ESCAPE ROUTE
APPLICATION**



FULL POWER
PLNÝ VÝKON



FULL POWER
LEGEND BRIGHTNESS > 200cd/m²
JAS PIKTOGRAMU > 200cd/m²



ECO MODE 50%



ECO MODE 25%



ECO MODE 10%
LEGEND BRIGHTNESS > 2cd/m²
JAS PIKTOGRAMU > 2cd/m²

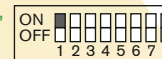

ONLY FOR CBS VERSIONS
ON - +2 BOTTOM LEDs CONTROL
OFF - DIMMING

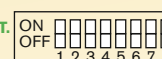

ONLY FOR CBS VERSIONS
ON - NEGATIVE
OFF - POSITIVE

**TO SEE THE CHANGE EITHER PUSH THE TEST BUTTON OR
DISCONNECT THE FIXTURE FROM BOTH THE MAINS 230V AND BATTERY**

Po prestavení stlačte TEST alebo odpojte batériu a pripojenie na sieť na aktiváciu zmeny

WALL OR CEILING MOUNTING TRENDLUX2

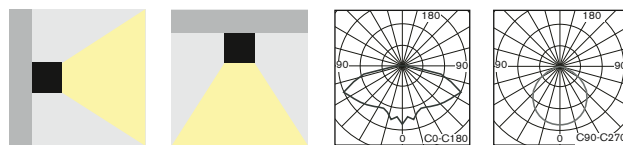

• **Impact resistant** surface or semi-recessed mounted powerful LED fixture with perfect light distribution for all non-maintained/maintained (NM/M) or centralised (C) emergency lighting available in all following versions:

- **AUTOTEST** (-AT)
- **DALI**
- **CENTRALTEST** (-ATXL) for ELMAX LOOK system (look up also page No.36)
- **CENTRAL BATTERY** (C.TRENDLUX) for **non-addressable CBS** (page No.44)
- **CENTRAL BATTERY** (-ATXP) for system **ELMAX-PATROLUX & Addressable CBS** (look up also page No.40)
- Conforming to the requirement of EN60598-2-22, EN1838, EN62034
- Design: Mirror effect AL reflector & PC impact resistant body

• **Mechanicky odolné IK10** výkonné LED núdzové svietidlo s perfektnou distribúciou svetla pre trvalé/netrvalé (NM/M) alebo (C) centrálné napájané núdzové osvetlenie dostupné vo verziách pre:

- **AUTOTEST** (-AT)
- **DALI**
- **CENTRALTEST** (-ATXL) pre systém ELMAX LOOK (pozri str.36)
- **CENTRAL BATTERY** (C.TRENDLUX) pre **neadresovateľné CBS** (str.44)
- **CENTRAL BATTERY** (-ATXP) pre systém **ELMAX-PATROLUX s adresovateľnou CBS** (pozri str. 40)

- spĺňa požiadavky európskej normy EN 60598-2-22, EN1838, EN62034
- konštrukcia: vysokoleštený AL reflektor a teleso z nerozbitného PC

STANDARD FEATURES

STANDARDNÁ VÝBAVA

- **High efficient MidPower (150lm/W) LONGLIFE LEDs 5000K (>100.000h)**
- **2pcs of High-Power bottom LEDs** 120lm/W for floor escape root illumination (valid only for all "+2xLED" versions)
- **NEW Advanced Electronics**
- **LONGLIFE LiFePo4 battery**
- **Installation Mode** (battery protection, for more details look up page No.50+69)
- **Intelligent battery charging** (intermittent charging, look up page No.50+69)
- **DIP Switch** allowing to preset following functions:
 - **ECO Mode** (dimming 10%-100%, for more details look up page No.50+69)
 - **ENERGY Saving Mode** (picto illumination 2cd/m² or 200cd/m², look up page 50+69)
 - **2 bottom LEDs control** (ON/OFF during operation on mains 230V, page No.50+69)
- Special mirror effect reflector
- Addressable CENTRALTEST communication module (for ATXL, ATXP only)
- LEDs indicating presence of power supply and signaling failures + TEST button
- **vysoko účinné MidPower LED 5000K (150lm/W) so životnosťou min.100000h**
- **2 výkonné LED 120lm/W pre osvetlenie únikovej cesty na podlahe** (len pri všetkých "+2xLED" verziách)
- **progresívna elektronická jednotka**
- **LONGLIFE LiFePo4 batéria**
- **Inštalovaný mód** (ochrana batérie, pozri aj str.50+69)
- **Inteligentné nabíjanie batérie** ("intermittent" nabíjanie, pozri aj str.50+69)
- **DIP prepínač** umožňujúci prednastavenie funkcií:
 - **ECO Mód** (stmievanie 10%-100%, pozri aj str.50+69)
 - **ENERGY Saving Mód** (osvetlenie picto na 2cd/m² alebo 200cd/m², pozri aj str.50+69)
- ovládanie **2 spodných LED** (zap/vyp počas normálneho režimu 230V)
- špeciálny odrazový reflektor so zrkadlovým efektom
- adresovateľný CENTRALTEST komunikačný modul (len pre ATXL, ATXP verzie)
- signalizácia LED a TEST tlačítko

OPTIONAL ACCESSORIES

PRÍPLATKY

- Non-adhesive legends & Mounting brackets (look up page No.72)
- fóliové piktogramy a montážne konzoly (pozri str.72)



Input Power:

- 5,8W/ 6,1VA (maintained M)
- 2,0W/ 3,9VA (non-maintained NM)
- 6,3W/ 6,5VA (CBS)

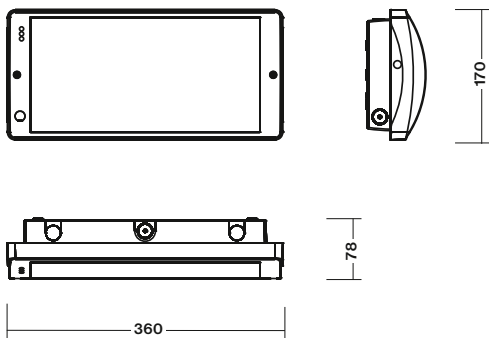

Optional Foil Legends
Príplatkový piktogram
(look up also page No.72)



Optional Semi-recessed accessories
Príplat.prísluš. pre polozapust. montáž
(look up also page No.72)



Optional Brackets
Príplatkové konzoly
(look up also page No.72)



Optional Protective Cage
Príplatková ochranná mreža
(look up also page No.72)



WALL OR CEILING MOUNTING TRENDLUX2



All "+2xLED" version are equipped with 2 additional Power LEDs which arrange perfect light distribution downward in order to get more light on the floor for wall mounting version. Or in case of legend on the diffuser the additional LEDs will arrange enough light level on the floor below the fixture.

Všetky "+2xLED" verzie sú vybavené 2 prídavnými výkonnými LED, ktoré zabezpečujú osvetlenie podlahy v prípade montáže svietidla na stenu (napr nad dvere), čo môže byť s výhodou použité aj v kombinácii s piktoqramom. Hlavné LED nasvietia piktoqram (smer únikovej cesty), spodné 2 LED zabezpečia nasvietenie únikovej cesty na dosiahnutie 1lx.

Page No.32

AUTOTEST -AT NM/M

Type	Version	Duration	Light Source	Light Flux / Emergency mode	Battery	Order Code	Weight
MULTITREND2-AT.1h	NM/M	1h	LED	430 lm / 310 lm	LiFePo4 6,4V/1,0Ah	277-B-300-04-00-00	1,6 kg
MULTITREND2-AT.3h	NM/M	3h	LED	430 lm / 310 lm	LiFePo4 6,4V/2,0Ah	277-B-301-04-00-00	1,6 kg
MULTITREND2-AT+2xLED.1h	NM/M	1h	LED	430+110 lm / 310+110 lm	LiFePo4 6,4V/1,0Ah	277-B-302-04-00-00	1,7 kg
MULTITREND2-AT+2xLED.3h	NM/M	3h	LED	430+110 lm / 310+110 lm	LiFePo4 6,4V/2,0Ah	277-B-303-04-00-00	1,8 kg

DALI Self-Contained

Type	Version	Duration	Light Source	Light Flux / Emergency mode	Battery	Order Code	Weight
MULTITREND2-DALI.1h	NM/M	1h	LED	430 lm / 310 lm	LiFePo4 6,4V/1,0Ah	277-B-309-04-00-00	1,7 kg

Page No.36

CENTRALTEST -ATXL ELMAX-LOOK

Type	Version	Duration	Light Source	Light Flux / Emergency mode	Battery	Order Code	Weight
MULTITREND2-ATXL.1h	NM/M	1h	LED	430 lm / 310 lm	LiFePo4 6,4V/1,0Ah	277-B-304-04-00-00	1,6 kg
MULTITREND2-ATXL.3h	NM/M	3h	LED	430 lm / 310 lm	LiFePo4 6,4V/2,0Ah	277-B-305-04-00-00	1,7 kg
MULTITREND2-ATXL+2xLED.1h	NM/M	1h	LED	430+110 lm / 190+110 lm	LiFePo4 6,4V/1,0Ah	277-B-306-04-00-00	1,7 kg
MULTITREND2-ATXL+2xLED.3h	NM/M	3h	LED	430+110 lm / 190+110 lm	LiFePo4 6,4V/2,0Ah	277-B-307-04-00-00	1,9 kg

Page No.38

Wireless CENTRALTEST ELMAX-WIRELESS

Type	Version	Duration	Light Source	Light Flux / Emergency mode	Battery	Order Code	Weight
MULTITREND2-ATRF.1h	NM/M	1h	LED	430 lm / 310 lm	LiFePo4 6,4V/1,0Ah	277-B-316-04-00-00	1,7 kg
MULTITREND2-ATRF.3h	NM/M	3h	LED	430 lm / 310 lm	LiFePo4 6,4V/2,0Ah	277-B-317-04-00-00	1,8 kg
MULTITREND2-ATRF+2xLED.1h	NM/M	1h	LED	430+110 lm / 310+110 lm	LiFePo4 6,4V/1,0Ah	277-B-318-04-00-00	1,8 kg
MULTITREND2-ATRF+2xLED.3h	NM/M	3h	LED	430+110 lm / 310+110 lm	LiFePo4 6,4V/2,0Ah	277-B-319-04-00-00	1,9 kg

DALI CENTRAL BATTERY (CBS)

Type	Version	Light Source	Light Flux	Order Code	Weight
C.TRENDLUX2-DALI 230V AC	DALI CBS	LED	650 lm	277-B-322-00-00-00	1,3 kg

Page No.44

CENTRAL BATTERY (CBS)

Type	Version	Light Source	Light Flux	Order Code	Weight
C.TRENDLUX2/230V AC/DC	CBS NON-ADDRESSABLE	LED	540 lm	277-B-312-00-00-00	1,3 kg
C.TRENDLUX2/24V AC/DC	CBS NON-ADDRESSABLE	LED	540 lm	277-B-313-00-00-00	1,3 kg
C.TRENDLUX2+2xLED/230V AC/DC	CBS NON-ADDRESSABLE	LED	540+110 lm	277-B-314-00-00-00	1,4 kg
C.TRENDLUX2+2xLED/24V AC/DC	CBS NON-ADDRESSABLE	LED	540+110 lm	277-B-315-00-00-00	1,4 kg

Page No.40

Addressable CENTRAL BATTERY (CBS) -ATXP ELMAX-PATROLUX

Type	Version	Light Source	Light Flux	Order Code	Weight
C.TRENDLUX2-ATXP/230V AC/DC	ATXP CBS ADDRESSABLE	LED	540 lm	277-B-308-00-00	1,3 kg
C.TRENDLUX2-ATXP+2LED/230V AC/DC	ATXP CBS ADDRESSABLE	LED	540+110 lm	277-B-310-00-00	1,5 kg

Look up pages No. 210-217 for 1lx Spacing tables
Pozri str.210-217 pre rozmiestnenie svietidiel na dosiahnutie 1lx

ACCESSORIES TRENDLUX2

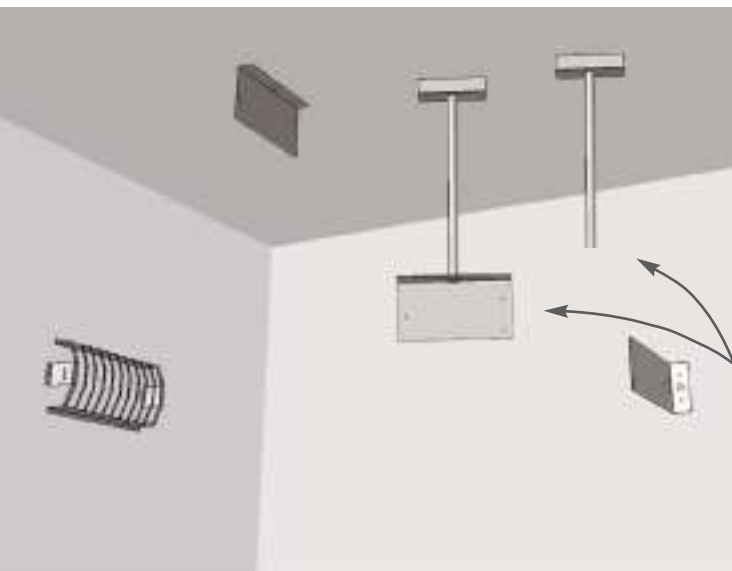

Options:

- Foil legend legend ISO7010 (must be ordered separately, order codes below)
- Viewing Distance: 35m
- Legend luminance >500cd/m² (white)

Príplatky:

- foliový piktogram podľa ISO7010 (musíte objednať samostatne-vid obj.kódy nižšie)
- rozoznatelnosť piktogramu: 35m
- jas piktogramu >500cd/m² (white)

Optional Item / Príplatok	Order Code / Objednávaci kód
Foil legend "H" / pikto fólia typ "H"	277-B-103-01-00
Foil legend "I" / pikto fólia typ "I"	277-B-104-01-00
Foil legend "J" / pikto fólia typ "J"	277-B-105-01-00
Foil legend "K" / pikto fólia typ "K"	277-B-107-01-00
Foil legend "L" / pikto fólia typ "L"	277-B-108-01-00
Foil legend "M" / pikto fólia typ "M"	277-B-109-01-00
Foil legend "N" / pikto fólia typ "N"	277-B-110-01-00
Foil legend "O" / pikto fólia typ "O"	277-B-111-01-00
Foil legend "Z1" / pikto fólia typ "Z1"	277-B-111-07-00
Foil legend "Z2" / pikto fólia typ "Z2"	277-B-111-08-00



Options:

- Semi-recessed mounting accessories

Príplatky:

- výbava pre polozapustenú montáž do stropu

Optional Item / Príplatok	Order Code / Objednávaci kód
Semi-recessed mouting accessories	277-B-210-01-00
Výbava pre polozapustenú montáž do stropu	277-B-210-01-00

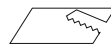

Recessed version mounting hole: 320x152 mm
Rozmer montážneho otvoru: 320x152 mm

Options:

- Wall / Ceiling / Pendant mounting bracket
- Protective Steel Cage

Príplatky:

- nástenná / stropná / závesná konzola
- ochranný kôš

Optional Item / Príplatok	Order Code / objednávaci kód
Wall mounting bracket / nástenná konzola	277-B-200-01-00
Ceiling mounting bracket / stropná konzola	277-B-201-01-00
Ceiling bracket 0,5m / závesná konzola 0,5m	277-B-202-01-00
Ceiling bracket 1,0m / závesná konzola 1,0m	277-B-203-01-00
Ceiling bracket 1,5m / závesná konzola 1,5m	277-B-204-01-00
Pendant bracket 0,5m / závesná konzola 0,5m	277-B-207-01-00
Pendant bracket 1,0m / závesná konzola 1,0m	277-B-208-01-00
Pendant bracket 1,5m / závesná konzola 1,5m	277-B-209-01-00
Protective stell cage / ochranný kôš	277-B-205-01-00

Train station area emergency lighting application



Light source	LED 5000K >500cd/m ² (white luminance) >200cd/m ² (average luminance)
Installed load	5.8W/6.1VA (maintained M) 2.0W/3.9VA (non-maintained NM) 6.3W/6.5VA (CBS)
Protection type	IP65 IK10
Housing material	Impact resistant polycarbonate
Viewing distance	35m

CEILING MOUNTING TRENDLUX2-TOP

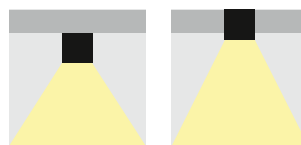

• Equisite IK10 IP65 design surface or semi-recessed mounted powerful double-sided LED fixture with perfect light distribution for non-maintained/maintained (NM/M) or centralised (C) emergency lighting available in all following versions:

- **AUTOTEST** (-AT)
- **DALI**
- **CENTRALTEST** (-ATXL) for ELMAX LOOK system (look up pages No.36)
- **Wireless CENTRALTEST** (-ATRF) for ELMAX-ATRF system (page No.38)
- **CENTRAL BATTERY** (C.TRENDLUX) for **non-addressable CBS** (page No.44)
- **CENTRAL BATTERY** (-ATXP) for system **ELMAX-PATROLUX & Addressable CBS** (look up also page No.40)
- Conforming to the requirement of EN60598-2-22, EN1838, EN62034
- Design: PC impact resistant body IK10

• kompaktné a elegantné výkonné núdzové svietidlo s perfektnou distribúciou svetla pre netrvalé (NM) alebo pre trvalé/netrvalé (NM/M) alebo (C) centrálné napájané núdzové osvetlenie dostupné vo verziách pre:

- **AUTOTEST** (-AT) alebo **DALI**
- **CENTRALTEST** (-ATXL) pre systém ELMAX LOOK (pozri str.36)
- **bezdrôtový CENTRALTEST** (-ATRF) pre ELMAX-ATRF systém (str.38)
- **CENTRAL BATTERY** (C.TRENDLUX) pre **neadresovateľné CBS** (str.44)
- **CENTRAL BATTERY** (-ATXP) pre systém **ELMAX-PATROLUX s adresovateľnou CBS** (pozri str. 40)

- spĺňa požiadavky európskej normy EN 60598-2-22, EN1838, EN62034
- konštrukcia: IK10 teleso z nerozbitného PC



Input Power:

- 5,8W/ 6,1VA (maintained M)
- 2,0W/ 3,9VA (non-maintained NM)
- 6,3W/ 6,5VA (CBS)

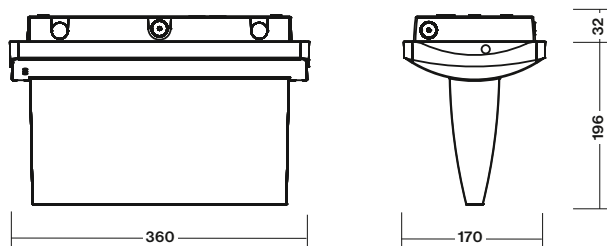

STANDARD FEATURES

STANDARDNÁ VÝBAVA

- **High efficient MidPower (150lm/W) LONGLIFE LEDs 5000K (>100.000h)**
- **NEW Advanced Electronics**
- **LONGLIFE LiFePo4 battery**
- **Installation Mode** (battery protection, for more details look up page No.51+75)
- **Intelligent battery charging** (intermittent charging, look up page No.No.51+75)
- **DIP Switch** allowing to preset following functions:
 - **ECO Mode** (dimming 10%-100%, for more details look up page No.No.51+75)
 - **ENERGY Saving Mode** (picto illumination 2cd/m² or 200cd/m², page 51+75)
- Special mirror effect reflector
- Addressable CENTRALTEST communication module (for ATXL, ATXP only)
- LEDs indicating presence of power supply and signaling failures & TEST button
- **vysoko účinné MidPower LED 5000K (150lm/W) so životnosťou min.100000h**
- **progresívna elektronická jednotka**
- **LONGLIFE LiFePo4 batéria**
- **Inštalčný mód** (ochrana batérie, pozri aj str.51+75)
- **Inteligentné nabíjanie batérie** ("intermittent" nabíjanie, pozri aj str.51+75)
- **DIP prepínač** umožňujúci prednastavenie funkcií:
 - **ECO Mód** (stmievanie 10%-100%, pozri aj str.51+75)
 - **ENERGY Saving Mód** (osvetlenie pikto 2cd/m² alebo 200cd/m², pozri str.51+75)
- špeciálny odrazový reflektor so zrkadlovým efektom
- adresovateľný CENTRALTEST komunikačný modul (len pre ATXL, ATXP verzie)
- signalizácia LED a TEST tlačítko

OPTIONAL ACCESSORIES

PRÍPLATKY

- Non-adhesive legends (look up page No.76)
- Wall mounting or pendant brackets (look up page No.76)
- Semi-recessed mounting accessories (look up page No.76)
- fóliové piktogramy (pozri str.76)
- nástenná alebo stropná závesná konzola (pozri str.76)
- príslušenstvo pre polozapustenú montáž do stropu (pozri str.76)



Optional Foil Legends
Príplatkový piktogram
(look up also page No.76)



Optional Semi-recessed accessories
Príplatkové príslušen. pre polozapustenú montáž
(look up also page No.76)



Optional Brackets
Príplatkové konzoly
(look up also page No.76)



SELF-CONTAINED BATTERY VERSIONS		CBS CENTRAL BATTERY VERSIONS	
NORMAL MODE 230V MAINS 	EMERGENCY BATTERY MODE 	DEFAULT SETT./ PREDNASTAVENÉ Full Power 	CBS CENTRAL BATTERY
		ECO MODE 50% (in 230V mode) EMERGENCY MODE LEGEND BRIGHTNESS > 200cd/m ² 	FULL POWER LEGEND BRIGHTNESS > 200cd/m ² JAS PIKTOGRAMU > 200cd/m ²
		ECO MODE 25% (in 230V mode) EMERGENCY MODE LEGEND BRIGHTNESS > 200cd/m ² 	ECO MODE 50%
		ECO MODE 10% (in 230V mode) EMERGENCY MODE LEGEND BRIGHTNESS > 200cd/m ² 	ECO MODE 25%
		ENERGY SAVING (in emerg.mode) LEGEND BRIGHTNESS > 2cd/m ² JAS PIKTOGRAMU > 2cd/m ² 	ECO MODE 10% LEGEND BRIGHTNESS > 2cd/m ² JAS PIKTOGRAMU > 2cd/m ²
		ENERGY SAVING (in emerg.mode) ECO MODE 50% (in 230V mode) LEGEND BRIGHTNESS > 2cd/m ² 	
		ENERGY SAVING (in emerg.mode) ECO MODE 25% (in 230V mode) LEGEND BRIGHTNESS > 2cd/m ² 	
		ENERGY SAVING (in emerg.mode) ECO MODE 10% (in 230V mode) LEGEND BRIGHTNESS > 2cd/m ² 	
	INSTALLATION MODE SET UP 	DEFAULT / PREDNASTAVENÉ OFF - ACTIVATED ON - DEACTIVATED 	
	NON-MAINTAINED / MAINTAINED MODE SET UP 	DEFAULT / PREDNASTAVENÉ ON - MAINTAINED OFF - NON-MAINTAINED 	
	AUTOTEST / CENTRALTEST MODE SET UP 	DEFAULT / PREDNASTAVENÉ OFF - AUTOTEST ON - CENTRALTEST 	
	NO-AUTOTEST MODE SET UP 	DEFAULT / PREDNASTAVENÉ OFF - AUTOTEST ACTIVE ON - NO-AUTOTEST 	

TO SEE THE CHANGE EITHER PUSH THE TEST BUTTON OR DISCONNECT THE FIXTURE FROM BOTH THE MAINS 230V AND BATTERY
 Po prestavení stlačte TEST alebo odpojte batériu a pripojenie na sieť na aktiváciu zmeny



Most advanced "V" twin LED light source with perfect light distribution. It is equipped with high efficient (150lm/W) LONGLIFE LEDs with the lifetime min 100.000h

Page No.32

AUTOTEST -AT NM/M

Type	Version	Duration	Light Source	Light Flux / Emergency mode	Battery	Order Code	Weight
MULTITREND2-TOP-AT.1h	NM/M	1h	LED	430 lm / 310 lm	LiFePo4 6,4V/1,0Ah	277-B-400-04-00-00	1,8 kg
MULTITREND2-TOP-AT.3h	NM/M	3h	LED	430 lm / 310 lm	LiFePo4 6,4V/2,0Ah	277-B-401-04-00-00	1,9 kg

DALI Self-Contained

Type	Version	Duration	Light Source	Light Flux / Emergency mode	Battery	Order Code	Weight
MULTITREND2-TOP-DALI.1h	NM/M	1h	LED	430 lm / 310 lm	LiFePo4 6,4V/1,0Ah	277-B-409-04-00-00	1,9 kg

Page No.36

CENTRALTEST -ATXL ELMAX-LOOK

Type	Version	Duration	Light Source	Light Flux / Emergency mode	Battery	Order Code	Weight
MULTITREND2-TOP-ATXL.1h	NM/M	1h	LED	430 lm / 310 lm	LiFePo4 6,4V/1,0Ah	277-B-402-04-00-00	1,9 kg
MULTITREND2-TOP-ATXL.3h	NM/M	3h	LED	430 lm / 310 lm	LiFePo4 6,4V/2,0Ah	277-B-403-04-00-00	2,0 kg

Page No.38

Wireless CENTRALTEST ELMAX-WIRELESS

Type	Version	Duration	Light Source	Light Flux / Emergency mode	Battery	Order Code	Weight
MULTITREND2-TOP-ATRF.1h	NM/M	1h	LED	430 lm / 310 lm	LiFePo4 6,4V/1,0Ah	277-B-407-04-00-00	1,7 kg
MULTITREND2-TOP-ATRF.3h	NM/M	3h	LED	430 lm / 310 lm	LiFePo4 6,4V/2,0Ah	277-B-408-04-00-00	1,8 kg

DALI CENTRAL BATTERY (CBS)

Type	Version	Light Source	Light Flux	Order Code	Weight
C.TRENDLUX2-TOP-DALI 230V AC	DALI CBS	LED	650 lm	277-B-410-04-00-00	1,3 kg

Page No.44

CENTRAL BATTERY (CBS)

Type	Version	Light Source	Light Flux	Order Code	Weight
C.TRENDLUX2-TOP/230V AC/DC	CBS NON-ADDRESSABLE	LED	540 lm	277-B-404-00-00-00	1,3 kg
C.TRENDLUX2-TOP/24V AC/DC	CBS NON-ADDRESSABLE	LED	540 lm	277-B-405-00-00-00	1,3 kg

Look up pages No. 210-217 for 1lx Spacing tables
 Pozri str.210-217 pre rozmiestnenie svietidiel na dosiahnutie 1lx

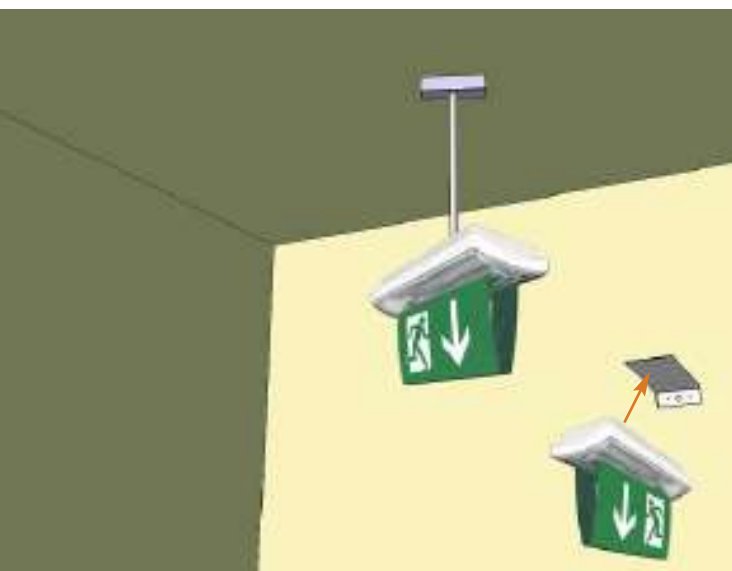
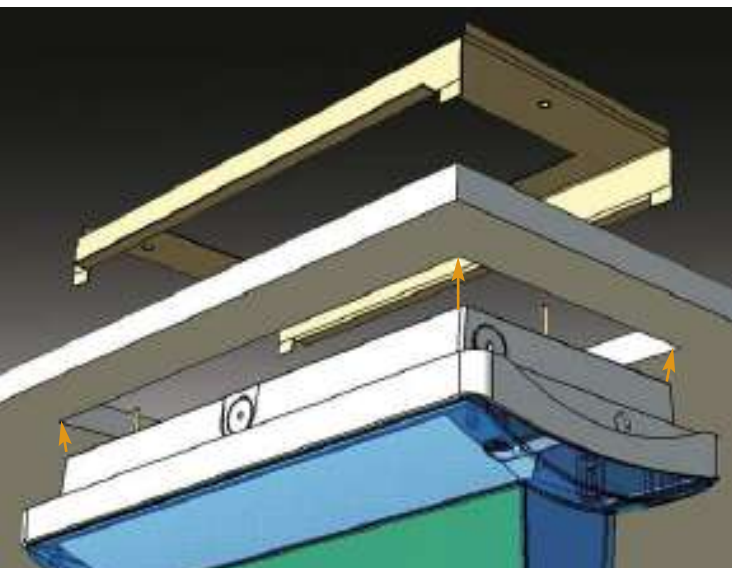
**Options:**

- Foil pictogram/legend complying ISO7010 (must be ordered separately, order codes below)
- Viewing Distance: 35m
- Legend luminance >500cd/m² (white)

Príplatky:

- foliový piktoqram v súlade s ISO7010 (musí sa objednať samostatne-vid' obj.kódy nižšie)
- rozoznatelnosť piktoqramu: 35m
- jas piktoqramu >500cd/m² (biela)

Optional Item / Príplatok	Order Code / Objednávaci kód
Foil legend "H" / pikto fólia typ "H"	277-B-103-01-00
Foil legend "I" / pikto fólia typ "I"	277-B-104-01-00
Foil legend "J" / pikto fólia typ "J"	277-B-105-01-00
Foil legend "K" / pikto fólia typ "K"	277-B-107-01-00
Foil legend "L" / pikto fólia typ "L"	277-B-108-01-00
Foil legend "M" / pikto fólia typ "M"	277-B-109-01-00
Foil legend "N" / pikto fólia typ "N"	277-B-110-01-00
Foil legend "O" / pikto fólia typ "O"	277-B-111-01-00
Foil legend "Z1" / pikto fólia typ "Z1"	277-B-111-07-00
Foil legend "Z2" / pikto fólia typ "Z2"	277-B-111-08-00

**Options:**

- Semi-recessed mounting accessories

Príplatky:

- výbava pre polozapustenú montáž do stropu

Optional Item / Príplatok	Order Code / Objednávaci kód
Semi-recessed mouting accessories	277-B-210-01-00
Výbava pre polozapustenú montáž do stropu	277-B-210-01-00

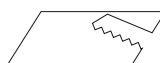

Recessed version mounting hole: 320x152 mm
Rozmer montážneho otvoru: 320x152 mm

Options:

- Wall / Ceiling Pendant mounting brackets

Príplatky:

- nástenná / stropná závesná konzola

Optional Item / Príplatok	Order Code / objednávaci kód
Wall mounting bracket / nástenná konzola	277-B-200-01-00
Pendant bracket 0,5m / závesná konzola 0,5m	277-B-207-01-00
Pendant bracket 1,0m / závesná konzola 1,0m	277-B-208-01-00
Pendant bracket 1,5m / závesná konzola 1,5m	277-B-209-01-00

CEILING MOUNTING TRENDLUX2-TOP

Light source	LED 5000K >500cd/m ² (white luminance) >200cd/m ² (average luminance)
Installed load	5.8W/6.1VA (maintained M) 2.0W/3.9VA (non-maintained NM) 6.3W/6.5VA (CBS)
Protection type	IP65 IK10
Housing material	Impact resistant polycarbonate
Viewing distance	35m

Industrial Area Emergency Lighting Application



WALL OR CEILING MOUNTING NORMALUX2



Most advanced "V" twin LED light source with perfect light distribution. It is equipped with high efficient (150lm/W) **LOGLIFE** LEDs with the lifetime min 100.000h

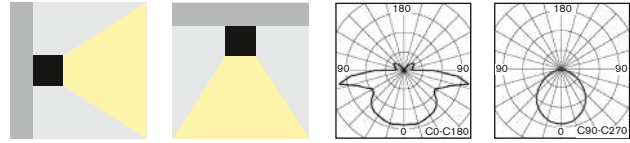

• **NEW Generation** of IK10 IP65 design surface mounted powerful LED fixture with perfect light distribution for all non-maintained/maintained (NM/M) or centralised (C) emergency lighting available in all following versions:

- **AUTOTEST** (-AT)
- **CENTRAL BATTERY** (C.NORMALUX2) for **non-addressable CBS** (look up page No.44)
- Conforming to the requirement of EN60598-2-22, EN1838, EN62034
- Design: PC impact resistant body
- **NOVÁ generácia** elegantného IP65 výkonného LED núdzového svietidla s perfektnou distribúciou svetla pre trvalé/netrvalé (NM/M) alebo (C) centrálné napájané núdzové osvetlenie dostupné vo verziách pre:
 - **AUTOTEST** (-AT)
 - **CENTRAL BATTERY** (C.NORMALUX2) pre **neadresovateľné CBS** (str.44)
- spĺňa požiadavky európskej normy EN 60598-2-22, EN1838, EN62034
- konštrukcia: teleso z nerozbitného PC

STANDARD FEATURES

ŠTANDARDNÁ VÝBAVA

- High efficient **MidPower (150lm/W) **LOGLIFE** LEDs 5000K (>100.000h)**
- **NEW Advanced Electronics**
- **LOGLIFE LiFePo4 battery**
- **Installation Mode** (battery protection, for more details look up page No.51+79)
- **Intelligent battery charging** (intermittent charging, look up page No.51+79)
- **DIP Switch** allowing to preset following functions:
 - **ECO Mode** (dimming 10%-100%, for more details look up page No.51+79)
 - **ENERGY Saving Mode** (picto illumination 2cd/m² or 200cd/m², look up page 51+79)
- Addressable **CENTRALTEST** communication module (for ATXL, ATXP only)
- LEDs indicating presence of power supply and signaling failures + **TEST** button
- Set of self-adhesive legends (H+I+J) complying ISO7010
- **vysoce účinné MidPower LED 5000K (150lm/W) so životnosťou min.100000h**
- **progresívna elektronická jednotka**
- **LOGLIFE LiFePo4 batéria**
- **Inštaláčny mód** (ochrana batérie, pozri aj str.51+79)
- **Inteligentné nabíjanie batérie** ("intermittent" nabíjanie, pozri aj str.51+79)
- **DIP prepínač** umožňujúci prednastavenie funkcií:
 - **ECO Mód** (stmievanie 10%-100%, pozri aj str.51+79)
 - **ENERGY Saving Mód** (osvetlenie pikto na 2cd/m² alebo 200cd/m², pozri str.51+79)
- adresovateľný **CENTRALTEST** komunikačný modul (len pre ATXL, ATXP verzie)
- signalizácia LED a **TEST** tlačítko
- sada samolepiacich piktogramov H+I+J v súlade s ISO7010



OPTIONAL ACCESSORIES

PRÍPLATKY

- Suspended plexi with single sided or double sided legend (look up page 82)
- Wall or ceiling mounting brackets (look up page No.82)
- Protective steel cage (look up page No.82)
- závesné plexi s jednostranným alebo obojstranným piktogramom (pozri str.82)
- nástenná, stropná alebo stropná závesná konzola (pozri str.82)
- ochranný kovový kôš (pozri str.82)



Optional Suspended plexi with Legends
Príplatkové závesné plexi s piktogramom
(look up also page No.82)



Optional Brackets and Protective Steel Cage
Príplatkové konzoly a ochranná mreža
(look up also page No.82)

← → 32m



Input Power:

- 5,8W/ 6,1VA (maintained M)
- 2,0W/ 3,9VA (non-maintained NM)
- 5,7W/ 6,0VA (CBS)

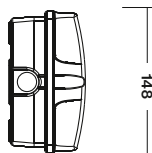

360

80

148

WALL OR CEILING MOUNTING NORMALUX2



DIP SWITCH FEATURES No.1-4 / DIP PREPÍNAČ č.1-4 - FUNKCIE

SELF-CONTAINED BATTERY VERSIONS

NORMAL MODE 230V MAINS	EMERGENCY BATTERY MODE	1 LUX ESCAPE ROUTE APPLICATION	ON OFF	NO LEGEND / BEZ PIKTOGRAMU ESCAPE ROUTE ILLUMINATION
1 LUX ESCAPE ROUTE APPLICATION	1 LUX ESCAPE ROUTE APPLICATION		ON OFF	DEFFAULT SETT./ PREDNASTAVENÉ Full Power for ESCAPE SIGN Applicaton BRIGHTNESS > 200cd/m ²
			ON OFF	ECO MODE 50% (in 230V mode) EMERGENCY MODE LEGEND BRIGHTNESS > 200cd/m ²
			ON OFF	ECO MODE 25% (in 230V mode) EMERGENCY MODE LEGEND BRIGHTNESS > 200cd/m ²
			ON OFF	ECO MODE 10% (in 230V mode) EMERGENCY MODE LEGEND BRIGHTNESS > 200cd/m ²
			ON OFF	ENERGY SAVING (in emerg.mode) LEGEND BRIGHTNESS > 2cd/m ² JAS PIKTOGRAMU > 2cd/m ²
			ON OFF	ENERGY SAVING (in emerg.mode) ECO MODE 50% (in 230V mode) LEGEND BRIGHTNESS > 2cd/m ²
			ON OFF	ENERGY SAVING (in emerg.mode) ECO MODE 25% (in 230V mode) LEGEND BRIGHTNESS > 2cd/m ²
			ON OFF	ENERGY SAVING (in emerg.mode) ECO MODE 10% (in 230V mode) LEGEND BRIGHTNESS > 2cd/m ²
	INSTALLATION MODE SET UP		ON OFF	DEFFAULT / PREDNASTAVENÉ OFF - ACTIVATED ON - DEACTIVATED
M / NM	NON-MAINTAINED / MAINTAINED MODE SET UP		ON OFF	DEFFAULT / PREDNASTAVENÉ ON - MAINTAINED OFF - NON-MAINTAINED
AT / ATXL	AUTOTEST / CENTRALTEST MODE SET UP		ON OFF	DEFFAULT / PREDNASTAVENÉ OFF - AUTOTEST ON - CENRALTEST
NO AT	NO-AUTOTEST MODE SET UP		ON OFF	DEFFAULT / PREDNASTAVENÉ OFF - AUTOTEST ACTIVE ON - NO-AUTOTEST

CBS CENTRAL BATTERY VERSIONS

CBS CENTRAL BATTERY	1 LUX ESCAPE ROUTE APPLICATION	ON OFF	FULL POWER PLNY VÝKON
		ON OFF	FULL POWER LEGEND BRIGHTNESS > 200cd/m ² JAS PIKTOGRAMU > 200cd/m ²
		ON OFF	ECO MODE 50%
		ON OFF	ECO MODE 25%
		ON OFF	ECO MODE 10% LEGEND BRIGHTNESS > 2cd/m ² JAS PIKTOGRAMU > 2cd/m ²
L1' Logic	L1' FUNCT. LOGIC SET UP	ON OFF	ONLY FOR CBS VERSIONS ON - NEGATIVE OFF - POSITIVE

TO SEE THE CHANGE EITHER PUSH THE TEST BUTTON OR DISCONNECT THE FIXTURE FROM BOTH THE MAINS 230V AND BATTERY

Po prestavení stlačte TEST alebo odpojte batériu a pripojenie na sieť na aktiváciu zmeny



Parking Garage Area Emergency Lighting Application

Page No.32

AUTOTEST -AT NM/M

Type	Version	Duration	Light Source	Light Flux / Emergency mode	Battery	Order Code	Weight
MULTINORMA2-AT.1h	NM/M	1h	LED	350 lm / 310 lm	LiFePo4 6,4V/1,0Ah	252-B-100-04-00-00	1,5 kg
MULTINORMA2-AT.3h	NM/M	3h	LED	350 lm / 310 lm	LiFePo4 6,4V/2,0Ah	252-B-101-04-00-00	1,6 kg

Page No.44

CENTRAL BATTERY (CBS)

Type	Version	Light Source	Light Flux	Order Code	Weight
C.NORMALUX2 230V AC/DC	CBS NON-ADDRESSABLE	LED	760 lm	252-B-106-00-00-00	1,2 kg
C.NORMALUX2 24V AC/DC	CBS NON-ADDRESSABLE	LED	760 lm	252-B-107-00-00-00	1,2 kg

Look up pages No. 210-217 for 1lx Spacing tables
Pozri str.210-217 pre rozmiestnenie svietidiel na dosiahnutie 1lx

WALL OR CEILING MOUNTING
NORMALUX2



Light source	LED 5000K >500cd/m ² (white luminance) >200cd/m ² (average luminance)
Installed load	5.8W/6.1VA (maintained M) 2.0W/3.9VA (non-maintained NM) 6.3W/6.5VA (CBS)
Protection type	IP65
Housing material	Impact resistant polycarbonate
Viewing distance	32/35m

CEILING MOUNTING WITH SUSPENDED LEGEND NORMALUX2





- Suspended plexi with single or double sided legend complying ISO7010
- Viewing Distance: 35m
- závesné plexi s jednostranným alebo obojstranným piktogramom v súlade s ISO7010
- rozoznatelnosť piktogramu: 35m

Optional Item / Príplatok	Order Code / Objednávaci kód
Suspended plexi H/J doublesided / obojstranné	252-B-23-05
Suspended plexi I doublesided / obojstranné	252-B-23-01
Suspended plexi H singlesided / jednostranné	252-B-23-06
Suspended plexi I singlesided / jednostranné	252-B-23-04
Suspended plexi J singlesided / jednostranné	252-B-23-07
Suspended plexi K/M doublesided / obojstranné	252-B-23-08
Suspended plexi L/N doublesided / obojstranné	252-B-23-09
Suspended plexi K singlesided / jednostranné	252-B-23-10
Suspended plexi L singlesided / jednostranné	252-B-23-11
Suspended plexi M singlesided / jednostranné	252-B-23-12
Suspended plexi N singlesided / jednostranné	252-B-23-13
Suspended plexi O singlesided / jednostranné	252-B-23-16
Suspended plexi O doublesided / obojstranné	252-B-23-17
Suspended plexi Z1 doublesided / obojstranné	252-B-23-21
Suspended plexi Z2 doublesided / obojstranné	252-B-23-22

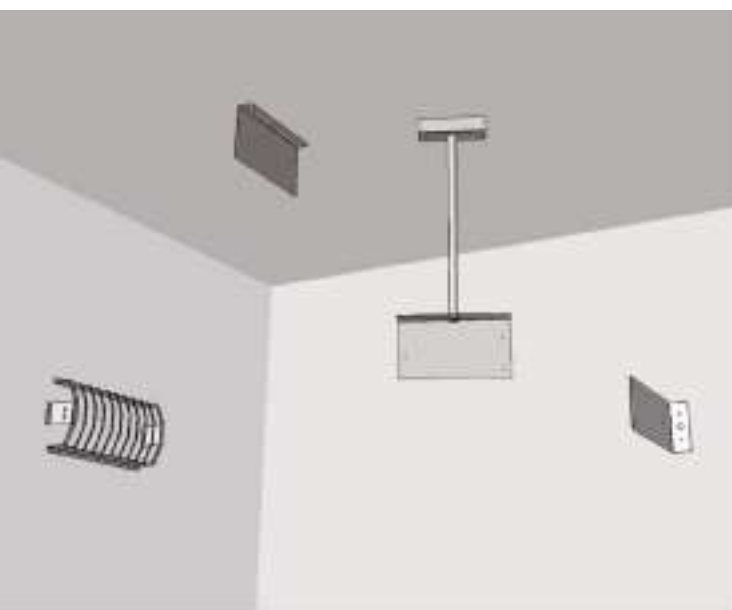
**Options:**

- Wall / Ceiling / Pendant mounting bracket
- Protective Steel Cage

Príplatky:

- nástenná / stropná / závesná konzola
- ochranný kôš

Optional Item : Príplatok :	Order Code : objednávaci kód :
Wall mounting bracket / nástenná konzola RAL9003	252-B-22-00
Ceiling mounting bracket / stropná konzola RAL9003	252-B-22-01-01
Ceiling mounting bracket / stropná konzola RAL9006	252-B-22-01
Pendant bracket 0,5m / závesná konzola 0,5m RAL9003	252-B-22-12-01
Pendant bracket 0,5m / závesná konzola 0,5m RAL9006	252-B-22-12-02
Pendant bracket 0,65m / závesná konz. 0,65m RAL9006	252-B-22-09
Pendant bracket 1,0m / závesná konzola 1,0m RAL9003	252-B-22-10-01
Pendant bracket 1,5m / závesná konzola 1,5m RAL9003	252-B-22-11-01
Protective steel cage / ochranný kôš RAL9003	252-B-22-05

CEILING MOUNTING WITH SUSPENDED LEGEND NORMALUX2

Parking garage area emergency lighting application

Light source	LED 5000K >500cd/m ² (white luminance) >200cd/m ² (average luminance)
Installed load	5.8W/6.1VA (maintained M) 2.0W/3.9VA (non-maintained NM) 6.3W/6.5VA (CBS)
Protection type	IP65
Housing material	Impact resistant polycarbonate
Viewing distance	32/35m



WALL OR CEILING MOUNTING PRIMALUX

Exclusive modern unobtrusive design based on high quality aluminum frame which enhances aesthetic and functional aspects of PRIMALUX type series. Combined with the qualities of an innovative LED light source - extra-long service life at constant light output - this escape sign luminaire boasts a special talent for low operating costs. The luminaire proves its application flexibility with its range of installation options.

Exkluzívny moderný nenápadný design vychádzajúci z kvalitného materiálu hliníkového rámu, ktorý ešte viac prehlbuje estetické a funkčné vlastnosti svietidiel typovej rady PRIMALUX. V kombinácii s kvalitami inovatívneho LED svetelného zdroja - extra dlhá životnosť pri konštantnom svetelnom výkone - sa môže toto núdzové svietidlo pochváliť špeciálnym talentom pre nízke prevádzkové a servisné náklady. PRIMALUX dokazuje svoju aplikačnú flexibilitu vďaka širokej typovej rade s rôznymi inštaláčnymi možnosťami.

Light source	LED 5000K
	>500cd/m ² (white luminance)
	>200cd/m ² (average luminance)
Installed load	5.8W/6.1VA (maintained M)
	2.0W/3.9VA (non-maintained NM)
	6.1W/6.3VA (CBS)
Frame cover material	Anodised aluminum
Viewing distance	30m
Application	Escape route lighting
Max luminaire spacing	up to 18m > 1lx
Application	Anti-panic lighting
Max room illumination	up to 86m² > 0.5lx



C.PRIMALUX / MULTIPRIMA
(Page No.86)

C.PRIMALUX / MULTIPRIMA escape sign luminaire

- Wall mounting escape sign LED emergency luminaire in accordance with EN1838
- Perfect uniform pictogram illumination
- Viewing distance: 30m/60m
- núdzové svietidlo pre montáž na stenu v súlade s EN1838
- perfektná rovnomernosť osvetlenia piktogramu
- rozoznatelnosť piktogramu: 30m/60m



C.PRIMALUX / MULTIPRIMA-A+2xLED
(Page No.86)

C.PRIMALUX-A+2xLED / MULTIPRIMA-A+2xLED

escape sign & escape route lighting (with 2 bottom HighPower LEDs)

- Wall mounting escape sign LED emergency luminaire in accordance with EN1838
- The additional bottom HighPower LEDs turn this fixture into escape sign and escape route/ anti-panic emergency lighting 2-in-1
- Perfect uniform pictogram illumination
- Maximum luminaire spacing: look up the page No.212
- Viewing distance: 30m

- núdzové svietidlo pre montáž na stenu v súlade s EN1838
- verzia s prídavnými spodnými HighPower LED je perfektnou kombináciou svietidla na vyznačenie smeru / osvetlenie únikovej cesty a anti-panic svietidla
- perfektná rovnomernosť osvetlenia piktogramu
- maximálny rozstup svietidiel: pozri str. 212
- rozoznatelnosť piktogramu: 30m



C.PRIMALUX / MULTIPRIMA-AP
(Page No.92)



C.PRIMALUX / MULTIPRIMA-APA
(Page No.92)



C.PRIMALUX / MULTIPRIMA-APB
(Page No.92)

C.PRIMALUX-AP/-AV/+2xLED MULTIPRIMA-AP/-AV/+2xLED

escape sign & escape route lighting / anti-panic lighting (with additional 2 bottom HighPower LEDs)

- Ceiling mounting double sided escape sign LED emergency luminaire in accordance with EN1838
- The additional bottom HighPower LEDs turn this fixture into escape sign and escape route/anti-panic emergency lighting 2in1
- Perfect uniform pictogram illumination
- Maximum luminaire spacing : up to 18m >1lx
- Maximum room illumination: up to 86m² >0.5lx
- Viewing distance: 30m

- núdzové svietidlo pre montáž na strop s obojstranným piktogramom v súlade s EN1838
- verzia s prídavnými spodnými HighPower LED je perfektnou kombináciou svietidla na vyznačenie/ osvetlenie smeru únikovej cesty a anti-panic núdzového svietidla
- perfektná rovnomernosť osvetlenia piktogramu
- maximálny rozstup svietidiel: až 18m >1lx
- maximálna plocha osvetlenia: až 86m² >0.5lx
- rozoznatelnosť piktogramu: 30m



C.PRIMALUX / MULTIPRIMA-AV
(Page No.99)



C.PRIMALUX / MULTIPRIMA-AVA
(Page No.99)



C.PRIMALUX / MULTIPRIMA-AVB
(Page No.99)

**C.PRIMALUX-AP
MULTIPRIMA-AP**

escape sign &
escape route lighting &
anti-panic lighting

(with additional 2 bottom HighPower LEDs)

All ceiling mounting types can be equipped with optional wire rope suspension set suitable for higher ceiling application. The wire rope suspension set must be ordered as separate item.

Všetky PRIMALUX-AP LED núdzové svietidlá s montážou na strop môžu byť vybavené lankovým závesným setom pre montáž v priestoroch s vyššou vnútornou výškou stropu. Závesná sada musí byť objednaná ako samostatná položka, ktorá sa montuje na štandardné svietidlo.



C.PRIMALUX / MULTIPRIMA-AP
+ wire suspension set
(Page No.92)

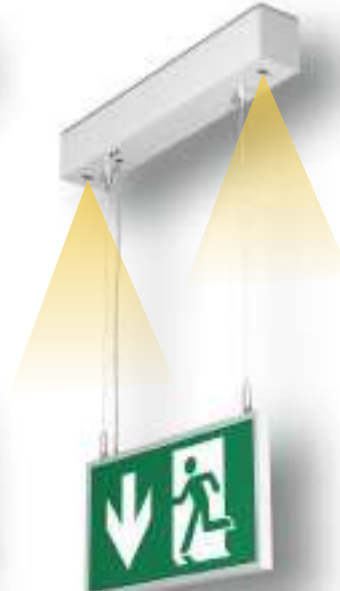

C.PRIMALUX / MULTIPRIMA-APA
+ wire suspension set
(Page No.92)



C.PRIMALUX / MULTIPRIMA-APB
+ wire suspension set
(Page No.92)

**C.PRIMALUX-AV
MULTIPRIMA-AV**

escape sign &
escape route lighting &
anti-panic lighting

(with 2 bottom HighPower LEDs)

All recessed mounting types can be equipped with the optional wire rope suspension set suitable for higher ceiling application.

The wire rope suspension set must be ordered as separate item.

Všetky PRIMALUX-AV LED núdzové svietidlá s montážou do stropu môžu byť vybavené lankovým závesným setom pre montáž v priestoroch s vyššou vnútornou výškou stropu. Závesná sada musí byť objednaná ako samostatná položka, ktorá sa montuje na štandardné svietidlo.



C.PRIMALUX / MULTIPRIMA-AV
+ wire suspension set
(Page No.99)



C.PRIMALUX / MULTIPRIMA-AVB
+ wire suspension set
(Page No.99)



C.PRIMALUX / MULTIPRIMA-AVB
+ wire suspension set
(Page No.99)

WALL MOUNTING PRIMALUX



← → 30m/60m

MULTIPRIMA-A / -B



← → 30m

MULTIPRIMA-A+2xLED

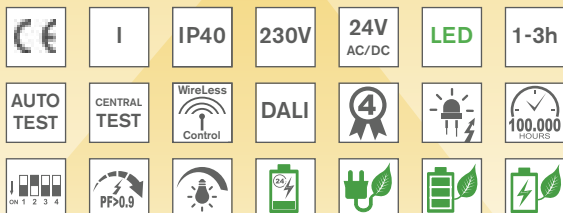

Input Power:

- 5,8W/ 6,1VA (maintained M)
- 2,0W/ 3,9VA (non-maintained NM)
- 6,1W/ 6,3VA (CBS)

Available in black RAL9005 colour

Order code on demand

Dostupné aj v čiernej farbe RAL9005

obj.kód na požiadanie

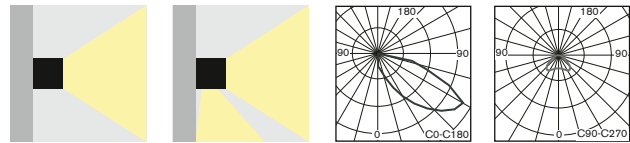

- Exclusive slim design surface mounted fixture for non-maintained/maintained (NM/M) or centralised (C) emergency lighting available in all following versions:

- **AUTOTEST** (-AT)
- **DALI**
- **CENTRALTEST** (-ATXL) for ELMAX LOOK system (look up also page No.36)
- **Wireless CENTRALTEST** (-ATRF) for ELMAX-ATRF system (page No.38)
- **CENTRAL BATTERY** (C.PRIMALUX) for **non-addressable CBS** (look up also page No.44)
- **CENTRAL BATTERY** (-ATXP) for system **ELMAX-PATROLUX & Addressable CBS** (look up also page No.40)
- Conforming to the requirement of EN60598-2-22, EN1838, EN62034
- Design:
 - Metal sheet base painted in RAL9003 colour
 - Acrylic layered diffuser with legend in anodised AL frame
- Elegantné "štíhle" núdzové svietidlo pre trvalé/netrvalé (NM/M) alebo (C) centrálné napájané núdzové osvetlenie dostupné vo verziách pre:
 - **AUTOTEST** (-AT) alebo **DALI**
 - **CENTRALTEST** (-ATXL) pre systém ELMAX LOOK (pozri str.36)
 - **bezdrôtový CENTRALTEST** (-ATRF) pre ELMAX-ATRF systém (str.38)
 - **CENTRAL BATTERY** (C.PRIMALUX) pre **neadresovateľné CBS** (str.44)
 - **CENTRAL BATTERY** (-ATXP) pre systém **ELMAX-PATROLUX s adresovateľnou CBS** (pozri str. 40)
- spĺňa požiadavky európskej normy EN 60598-2-22, EN1838, EN62034
- konštrukcia:
 - základňa z ocelového plechu v bielej farbe RAL9003
 - svetelno-činný kryt z vrstveného plexi v ráme z eloxovaného hliníku

STANDARD FEATURES

STANDARDNÁ VÝBAVA

- **High efficient (150lm/W, 5000K) LONGLIFE LEDs (>100.000h)**
- **2pcs of High-Power bottom LEDs 120lm/W** for floor escape root illumination (valid only for all "+2xLED" versions)
- **NEW Advanced Electronics**
- **LONGLIFE NiMH or LiFePo4 battery**
- **Installation Mode** (battery protection, for more details look up page No.51+58)
- **Intelligent battery charging** (intermittent charging, look up page No.51+58)
- **DIP Switch** allowing to preset following functions:
 - **ECO Mode** (dimming 10%-100%, for more details look up page No.51+58)
 - **ENERGY Saving Mode** (picto illumination 2cd/m² or 200cd/m², look page 51+58)
 - **2 bottom LEDs control** (ON/OFF during operation on mains 230V, page 51+58)
- Special layered diffuser for perfect smooth pictogram illumination
- Addressable CENTRALTEST communication module (for ATXL, ATXP only)
- LEDs indicating presence of power supply and signaling failures + TEST button
- **vysoko účinné LED (150lm/W, 5000K) so životnosťou min.100000h**
- **2 výkonné LED 120lm/W** pre osvetlenie únikovej cesty na podlahe (len pri "+2xLED" verziách)
- **progressívna elektronická jednotka**
- **LONGLIFE NiMH alebo LiFePo4 batéria**
- **Inštaláčny mód** (ochrana batérie, pozri aj str.51+58)
- **Inteligentné nabíjanie batérie** ("intermittent" nabíjanie, pozri aj str.51+58)
- **DIP prepínač** umožňujúci prednastavenie funkcií:
 - **ECO Mód** (stmievanie 10%-100%, pozri aj str.51+58)
 - **ENERGY Saving Mód** (osvetlenie pikto na 2cd/m² alebo 200cd/m², pozri 51+58)
 - ovládanie **2 spodných LED** (zap/vyp počas normálneho režimu 230V)
- špeciálne vrstvené plexi pre perfektné rovnomerné osvetlenie piktoqramu
- adresovateľný CENTRALTEST komunikačný modul (len pre ATXL, ATXP verzie)
- signalizácia LED a TEST tlačítko



Accessory: Diffuser in AL Frame+Legend
Príplatkový kryt svietidla v AL ráme+pikto
(look up also page No.90)



Optional Brackets
Príplatkové konzoly
(look up also page No.90)

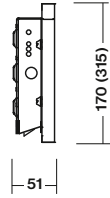
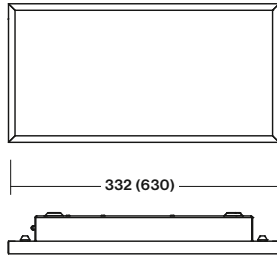

* Dimensions in the bracket are valid for all "B" versions
* rozmery v zátvorke platia pre všetky "B" verzie

Available in black RAL9005 colour
Order code on demand
Dostupné aj v čiernej farbe RAL9005
obj.kód na požiadanie

Page No.32

AUTOTEST -AT NM/M

Type	Version	Duration	Light Source	Light Flux/Emerg.mode	Battery	Order Code	Weight
MULTIPRIMA-A-AT.1h	NM/M	1h	MidPower LEDs	N.A.	LiFePo4 6,4V/1,0Ah	295-B-001-04-00-00	1,6 kg
MULTIPRIMA-A-AT.3h	NM/M	3h	MidPower LEDs	N.A.	LiFePo4 6,4V/2,0Ah	295-B-002-04-00-00	1,7 kg
MULTIPRIMA-A-AT+2xLED.1h	NM/M	1h	MidPwr LED+2x LED	- / 100 lm	LiFePo4 6,4V/1,0Ah	295-B-003-04-00-00	1,7 kg
MULTIPRIMA-A-AT+2xLED.3h	NM/M	3h	MidPwr LED+2x LED	- / 100 lm	LiFePo4 6,4V/2,0Ah	295-B-004-04-00-00	1,8 kg
MULTIPRIMA-B-AT.1h	NM/M	1h	MidPwr LED+2x LED	- / 100 lm	LiFePo4 6,4V/1,0Ah	295-B-005-04-00-00	3,5 kg
MULTIPRIMA-B-AT.3h	NM/M	3h	MidPwr LED+2x LED	- / 100 lm	LiFePo4 6,4V/2,0Ah	295-B-006-04-00-00	3,6 kg

DALI Self-Contained

Type	Version	Duration	Light Source	Light Flux	Battery	Order Code	Weight
MULTIPRIMA-A-DALI.1h	NM/M	1h	MidPower LEDs	N.A.	LiFePo4 6,4V/1,0Ah	295-B-032-04-00-00	1,6 kg
MULTIPRIMA-A-DALI.3h	NM/M	3h	MidPower LEDs	N.A.	LiFePo4 6,4V/2,0Ah	295-B-033-04-00-00	1,6 kg

Page No.36

CENTRALTEST -ATXL ELMAX-LOOK

Type	Version	Duration	Light Source	Light Flux/Emerg.mode	Battery	Order Code	Weight
MULTIPRIMA-A-ATXL.1h	NM/M	1h	MidPower LEDs	N.A.	LiFePo4 6,4V/1,0Ah	295-B-007-04-00-00	1,7 kg
MULTIPRIMA-A-ATXL.3h	NM/M	3h	MidPower LEDs	N.A.	LiFePo4 6,4V/2,0Ah	295-B-008-04-00-00	1,8 kg
MULTIPRIMA-A-ATXL+2xLED.1h	NM/M	1h	MidPwr LED+2x LED	- / 100 lm	LiFePo4 6,4V/1,0Ah	295-B-009-04-00-00	1,8 kg
MULTIPRIMA-A-ATXL+2xLED.3h	NM/M	3h	MidPwr LED+2x LED	- / 100 lm	LiFePo4 6,4V/2,0Ah	295-B-010-04-00-00	1,9 kg
MULTIPRIMA-B-ATXL.1h	NM/M	1h	MidPower LEDs	N.A.	LiFePo4 6,4V/1,0Ah	295-B-011-04-00-00	3,6 kg
MULTIPRIMA-B-ATXL.3h	NM/M	3h	MidPower LEDs	N.A.	LiFePo4 6,4V/2,0Ah	295-B-012-04-00-00	3,6 kg

Page No.38

Wireless CENTRALTEST ELMAX-ATRF

Type	Version	Duration	Light Source	Light Flux	Battery	Order Code	Weight
MULTIPRIMA-A-ATRF.1h	NM/M	1h	MidPower LEDs	N.A.	LiFePo4 6,4V/1,0Ah	295-B-013-04-00-00	1,7 kg
MULTIPRIMA-A-ATRF.3h	NM/M	3h	MidPower LEDs	N.A.	LiFePo4 6,4V/2,0Ah	295-B-014-04-00-00	1,8 kg
MULTIPRIMA-A-ATRF+2xLED.1h	NM/M	1h	MidPwr LED+2x LED	- / 100 lm	LiFePo4 6,4V/1,0Ah	295-B-015-04-00-00	1,8 kg
MULTIPRIMA-A-ATRF+2xLED.3h	NM/M	3h	MidPwr LED+2x LED	- / 100 lm	LiFePo4 6,4V/2,0Ah	295-B-016-04-00-00	1,8 kg
MULTIPRIMA-B-ATRF.1h	NM/M	1h	MidPower LEDs	N.A.	LiFePo4 6,4V/1,0Ah	295-B-017-04-00-00	3,6 kg
MULTIPRIMA-B-ATRF.3h	NM/M	3h	MidPower LEDs	N.A.	LiFePo4 6,4V/2,0Ah	295-B-018-04-00-00	3,6 kg

Page No.44

CENTRAL BATTERY (CBS)

Type	Version	Light Source	Light Flux	Order Code	Weight
C.PRIMALUX-A 230V AC/DC	CBS NON-ADDRESSABLE	MidPower LEDs	N.A.	295-B-019-00-00-00	1,3 kg
C.PRIMALUX-A 24V AC/DC	CBS NON-ADDRESSABLE	MidPower LEDs	N.A.	295-B-020-00-00-00	1,3 kg
C.PRIMALUX-A+2xLED 230V AC/DC	CBS NON-ADDRESSABLE	MidPower LEDs+2x LEDs	100 lm	295-B-021-00-00-00	1,4 kg
C.PRIMALUX-A+2xLED 24V AC/DC	CBS NON-ADDRESSABLE	MidPower LEDs+2x LEDs	100 lm	295-B-022-00-00-00	1,4 kg
C.PRIMALUX-B 230V AC/DC	CBS NON-ADDRESSABLE	MidPower LEDs	N.A.	295-B-023-00-00-00	3,1 kg
C.PRIMALUX-B 24V AC/DC	CBS NON-ADDRESSABLE	MidPower LEDs	N.A.	295-B-024-00-00-00	3,1 kg

DALI CENTRAL BATTERY (CBS)

Type	Version	Light Source	Light Flux	Order Code	Weight
C.PRIMALUX-A-DALI 230V AC	DALI CBS	MidPower LEDs	N.A.	295-B-034-00-00-00	1,3 kg

Page No.40

Addressable CENTRAL BATTERY (CBS) -ATXP ELMAX-PATROLUX

Type	Version	Light Source	Light Flux	Order Code	Weight
C.PRIMALUX-A-ATXPR 230V AC/DC	ATXP CBS ADDRESSABLE	MidPower LEDs	N.A.	295-B-025-00-00-00	1,4 kg
C.PRIMALUX-A-ATXPR+2xLED 230V AC/DC	ATXP CBS ADDRESSABLE	MidPwr LED+2x LED	100 lm	295-B-026-00-00-00	1,5 kg
C.PRIMALUX-B-ATXPR 230V AC/DC	ATXP CBS ADDRESSABLE	MidPower LEDs	N.A.	295-B-027-00-00-00	3,2 kg

Look up pages No. 210-217 for 1lx Spacing tables
Pozri str.210-217 pre rozmiestnenie svetidiel na dosiahnutie 1lx

PRIMALUX



ENERGY SAVING
ECO MODE
SET UP



2/200
cd/m²

NO
AT

DIP SWITCH FEATURES No.1-4 / DIP PREPÍNAČ č.1-4 - FUNKCIE

SELF-CONTAINED BATTERY VERSIONS

NORMAL MODE
230V MAINS

EMERGENCY
BATTERY MODE



DEFFAULT SETT./ PREDNASTAVENÉ
Full Power for ESCAPE SIGN Applicaton
BRIGHTNESS > 200cd/m²



ECO MODE 50% (in 230V mode)
EMERGENCY MODE LEGEND
BRIGHTNESS > 200cd/m²



ECO MODE 25% (in 230V mode)
EMERGENCY MODE LEGEND
BRIGHTNESS > 200cd/m²



ECO MODE 10% (in 230V mode)
EMERGENCY MODE LEGEND
BRIGHTNESS > 200cd/m²

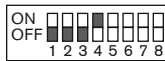

ENERGY SAVING (in emerg.mode)
LEGEND BRIGHTNESS > 2cd/m²
JAS PIKTOGRAMU > 2cd/m²



ENERGY SAVING (in emerg.mode)
ECO MODE 50% (in 230V mode)
LEGEND BRIGHTNESS > 2cd/m²

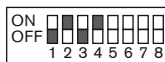

ENERGY SAVING (in emerg.mode)
ECO MODE 25% (in 230V mode)
LEGEND BRIGHTNESS > 2cd/m²

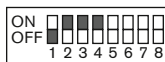

ENERGY SAVING (in emerg.mode)
ECO MODE 10% (in 230V mode)
LEGEND BRIGHTNESS > 2cd/m²



INSTALLATION
MODE
SET UP

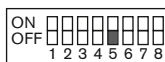

DEFFAULT / PREDNASTAVENÉ
OFF - ACTIVATED
ON - DEACTIVATED



NON-MAINTAINED /
MAINTAINED
MODE
SET UP

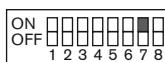

DEFFAULT / PREDNASTAVENÉ
ON - MAINTAINED
OFF - NON-MAINTAINED



NO-AUTOTEST
MODE
SET UP



DEFFAULT / PREDNASTAVENÉ
OFF - AUTOTEST ACTIVE
ON - NO-AUTOTEST

CBS CENTRAL BATTERY VERSIONS

CBS CENTRAL
BATTERY

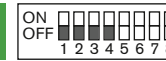

FULL POWER
LEGEND BRIGHTNESS > 200cd/m²
JAS PIKTOGRAMU > 200cd/m²

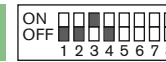

ECO MODE 50%

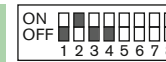

ECO MODE 25%

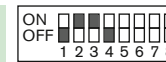

ECO MODE 10%
LEGEND BRIGHTNESS > 2cd/m²
JAS PIKTOGRAMU > 2cd/m²



L1' FUNCT.
LOGIC
SET UP



ONLY FOR CBS VERSIONS
ON - NEGATIVE
OFF - POSITIVE

TO SEE THE CHANGE EITHER PUSH THE TEST BUTTON OR DISCONNECT THE FIXTURE FROM BOTH THE MAINS 230V AND BATTERY

Po prestavení stlačte TEST alebo odpojte batériu a pripojenie na sieť na aktiváciu zmeny

Premium Line

DIP SWITCH FUNCTIONALITY

C.PRIMALUX+2xLED / MULTIPRIMA+2xLED

DIP SWITCH FEATURES No.1-4 / DIP PREPÍNAČ č.1-4 - FUNKCIE

SELF-CONTAINED BATTERY VERSIONS (not valid for DALI versions)

NORMAL MODE
230V MAINS

EMERGENCY
BATTERY MODE

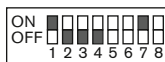

NO LEGEND / BEZ PIKTOGRAMU
ESCAPE ROUTE ILLUMINATION



DEFFAULT SETT./ PREDNASTAVENÉ
Full Power for ESCAPE SIGN Applicaton
BRIGHTNESS > 200cd/m²

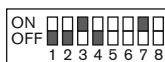

ECO MODE 50% (in 230V mode)
EMERGENCY MODE LEGEND
BRIGHTNESS > 200cd/m²



ECO MODE 25% (in 230V mode)
EMERGENCY MODE LEGEND
BRIGHTNESS > 200cd/m²

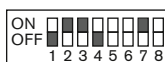

ECO MODE 10% (in 230V mode)
EMERGENCY MODE LEGEND
BRIGHTNESS > 200cd/m²



ENERGY SAVING (in emerg.mode)
LEGEND BRIGHTNESS > 2cd/m²
JAS PIKTOGRAMU > 2cd/m²



ENERGY SAVING (in emerg.mode)
ECO MODE 50% (in 230V mode)
LEGEND BRIGHTNESS > 2cd/m²



ENERGY SAVING (in emerg.mode)
ECO MODE 25% (in 230V mode)
LEGEND BRIGHTNESS > 2cd/m²



ENERGY SAVING (in emerg.mode)
ECO MODE 10% (in 230V mode)
LEGEND BRIGHTNESS > 2cd/m²



INSTALLATION
MODE
SET UP



DEFFAULT / PREDNASTAVENÉ
OFF - ACTIVATED
ON - DEACTIVATED



NON-MAINTAINED /
MAINTAINED
MODE
SET UP



DEFFAULT / PREDNASTAVENÉ
ON - MAINTAINED
OFF - NON-MAINTAINED



NO-AUTOTEST
MODE
SET UP



DEFFAULT / PREDNASTAVENÉ
OFF - AUTOTEST ACTIVE
ON - NO-AUTOTEST

CBS CENTRAL BATTERY VERSIONS (not valid for DALI versions)

CBS CENTRAL
BATTERY

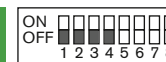

FULL POWER
LEGEND BRIGHTNESS > 200cd/m²
JAS PIKTOGRAMU > 200cd/m²



ECO MODE 50%



ECO MODE 25%



ECO MODE 10%
LEGEND BRIGHTNESS > 2cd/m²
JAS PIKTOGRAMU > 2cd/m²



INPUT L1'
FUNCT.
SET UP



ONLY FOR CBS VERSIONS
ON - +2 BOTTOM LEDs CONTROL
OFF - DIMMING



L1' FUNCT.
LOGIC
SET UP

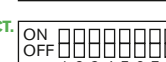

ONLY FOR CBS VERSIONS
ON - NEGATIVE
OFF - POSITIVE

TO SEE THE CHANGE EITHER PUSH THE TEST BUTTON OR DISCONNECT THE FIXTURE FROM BOTH THE MAINS 230V AND BATTERY

Po prestavení stlačte TEST alebo odpojte batériu a pripojenie na sieť na aktiváciu zmeny



Light source	LED 5000K >500cd/m ² (white luminance) >200cd/m ² (average luminance)
Installed load	5.8W/6.1VA (maintained M) 2.0W/3.9VA (non-maintained NM) 6.1W/6.3VA (CBS)
Frame cover material	Anodised aluminum
Viewing distance	30m
Application	Escape route lighting
Max luminaire spacing	Look up page No.212
Application	Anti-panic lighting
Max room illumination	Look up page No.212



Available in black RAL9005 colour
Order code on demand
Dostupné aj v čiernej farbe RAL9005
obj.kód na požiadanie

- Diffuser in AL frame including legend in accordance with ISO7010
- **It is not included in standard package. It must be ordered as separate item !**
- Viewing Distance 30m: (for all "A" size versions), 60m (for all "B" size versions)
- Legend luminance >500cd/m² (white)
- kryt svietidla v AL ráme s piktogramom v súlade s ISO7010
- **nie je súčasťou štandardného balenia svietidla, musí byť objednané ako samostatná položka !**
- rozoznateľnosť piktogramu: 30m (pre veľkosť A), 60m (pre veľkosť B)
- jas piktogramu >500cd/m² (biela)



All "A" Size versions / pre všetky verzie veľkosť "A"	Order Code / Objednávaci kód
Diffuser with legend "H" / kryt s pikto typ "H"	295-B-000-01-00-00
Diffuser with legend "I" / kryt s pikto typ "I"	295-B-000-02-00-00
Diffuser with legend "J" / kryt s pikto typ "J"	295-B-000-03-00-00
Diffuser with legend "K" / kryt s pikto typ "K"	295-B-000-04-00-00
Diffuser with legend "L" / kryt s pikto typ "L"	295-B-000-05-00-00
Diffuser with legend "M" / kryt s pikto typ "M"	295-B-000-06-00-00
Diffuser with legend "N" / kryt s pikto typ "N"	295-B-000-07-00-00
Diffuser with legend "O" / kryt s pikto typ "O"	295-B-000-08-00-00

All "B" Size versions / pre všetky verzie veľkosť "B"	Order Code / Objednávaci kód
Diffuser with legend "H" / kryt s pikto typ "H"	295-B-000-10-00-00
Diffuser with legend "I" / kryt s pikto typ "I"	295-B-000-11-00-00
Diffuser with legend "J" / kryt s pikto typ "J"	295-B-000-12-00-00
Diffuser with legend "K" / kryt s pikto typ "K"	295-B-000-13-00-00
Diffuser with legend "L" / kryt s pikto typ "L"	295-B-000-14-00-00
Diffuser with legend "M" / kryt s pikto typ "M"	295-B-000-15-00-00
Diffuser with legend "N" / kryt s pikto typ "N"	295-B-000-16-00-00
Diffuser with legend "O" / kryt s pikto typ "O"	295-B-000-20-00-00

Additional Bottom HighPower LEDs (valid only for all "+2xLED" versions")

- for escape route illumination on the floor
- for 1x Spacing Tables Look up Page No.212
- Prídavné 2x HighPower LED na spodnej strane svietidla (len pre verzie "+2xLED")
- pre nasvietenie únikovej cesty na podlahe
- tabuľky rozmiestnenia svietidiel pre 1x hladinu osvetlenia pozri str. 212

Options: / Příplatky:

- Wall / Ceiling / Pendant mounting bracket
- Protective Steel Cage
- nástenná / stropná / závesná konzola
- ochranný kôš

Optional Item / Příplatek	Order Code / objednávaci kód
Wall mounting bracket "A" / nástenná konzola "A"	295-B-200-01
Wall mounting bracket "B" / nástenná konzola "B"	295-B-200-02
Ceiling mounting bracket "A" / stropná konzola "A"	295-B-201-01
Ceiling mounting bracket "B" / stropná konz. "B"	295-B-201-02
Pendant bracket 0,5m "A" / záves. konz. 0,5m "A"	295-B-202-01
Pendant bracket 0,5m "B" / záves. konz. 0,5m "B"	295-B-202-02
Pendant bracket 1,0m "A" / záves. konz. 1,0m "A"	295-B-203-01
Pendant bracket 1,0m "B" / záves. konz. 1,0m "B"	295-B-203-02
Pendant bracket 1,5m "A" / záves. konz. 1,5m "A"	295-B-204-01
Pendant bracket 1,5m "B" / záves. konz. 1,5m "B"	295-B-204-02
Protective stell cage "A" / ochranný kôš "A"	295-B-205-01
Protective stell cage "B" / ochranný kôš "B"	295-B-205-02

WALL MOUNTING PRIMALUX



Light source	LED 5000K >500cd/m ² (white luminance) >200cd/m ² (average luminance)
Installed load	5.8W/6.1VA (maintained M) 2.0W/3.9VA (non-maintained NM) 6.1W/6.3VA (CBS)
Frame cover material	Anodised aluminum
Viewing distance	30m
Application	Escape route lighting
Max luminaire spacing	Look up page No.212
Application	Anti-panic lighting
Max room illumination	Look up page No.212

CEILING MOUNTING WITH SUSPENDED LEGEND PRIMALUX



← → 30m

MULTIPRIMA-AP



← → 30m

MULTIPRIMA-APB+2xLED

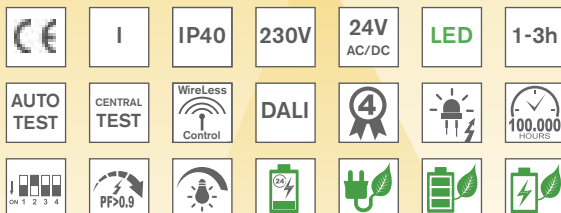

Input Power:

- 5,8W/ 6,1VA (maintained M)
- 2,0W/ 3,9VA (non-maintained NM)
- 6,1W/ 6,3VA (CBS)

Available in black RAL9005 colour

Order code on demand

Dostupné aj v čiernej farbe RAL9005

obj.kód na požiadanie

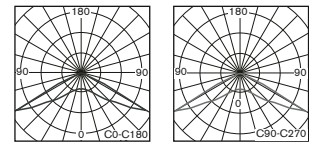
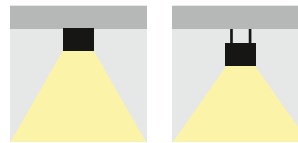
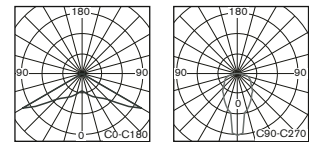

- Exclusive slim design doublesided ceiling mounted fixture for non-maintained/ maintained (NM/M) or centralised (C) emergency lighting available in all following versions:

- **AUTOTEST** (-AT)
- **DALI**
- **CENTRALTEST** (-ATXL) for ELMAX LOOK system (look up also page No.36)
- **Wireless CENTRALTEST** (-ATRF) for ELMAX-ATRF system (page No.38)
- **CENTRAL BATTERY** (C.PRIMALUX) for **non-addressable CBS** (look up also page No.44)
- **CENTRAL BATTERY** (-ATXP) for system **ELMAX-PATROLUX & Addressable CBS** (look up also page No.40)
- Conforming to the requirement of EN60598-2-22, EN1838, EN62034
- Design:
 - Anodised AL profile base
 - Acrylic layered diffuser with legend in anodised AL frame

- Elegatné "štíhle" obojstranné stropné núdzové svietidlo pre netrválne/trvalé (NM/M) alebo (C) centrálné napájané núdzové osvetlenie dostupné vo verziách:

- **AUTOTEST** (-AT)
- **DALI**
- **CENTRALTEST** (-ATXL) pre systém ELMAX LOOK (pozri str.36)
- **bezdrôtový CENTRALTEST** (-ATRF) pre ELMAX-ATRF systém (str.38)
- **CENTRAL BATTERY** (C.PRIMALUX) pre **neadresovateľné CBS** (str.44)
- **CENTRAL BATTERY** (-ATXP) pre systém **ELMAX-PATROLUX s adresovateľnou CBS** (pozri str. 40)
- spĺňa požiadavky európskej normy EN 60598-2-22, EN1838, EN62034
- konštrukcia:
 - základňa z eloxovaného hliníkového profilu
 - svetelno-činný kryt z vrstveného plexi v ráme z eloxovaného hliníku

STANDARD FEATURES

STANDARDNÁ VÝBAVA

- **High efficient (150lm/W, 5000K) LONGLIFE LEDs (>100.000h)**
- **2pcs of High-Power bottom LEDs 120lm/W** for floor escape root illumination (valid only for all "+2xLED" versions)
- **NEW Advanced Electronics**
- **LONGLIFE LiFePo4 battery**
- **Installation Mode** (battery protection, for more details look up page No.51+88)
- **Intelligent battery charging** (intermittent charging, look up page No.51+88)
- **DIP Switch** allowing to preset following functions:
 - **ECO Mode** (dimming 10%-100%, for more details look up page No.51+88)
 - **ENERGY Saving Mode** (picto illumination 2cd/m² or 200cd/m², look up page 51+88)
 - **2 bottom LEDs control** (ON/OFF during operation on mains 230V, page No.51+88)
- Special layered diffuser for perfect smooth pictogram illumination
- Addressable CENTRALTEST communication module (for ATXL, ATXP only)
- LEDs indicating presence of power supply and signaling failures & TEST button
- **vysoko účinné LED (150lm/W, 5000K) so životnosťou min.100000h**
- **2 výkonné LED 120lm/W** pre osvetlenie únikovej cesty na podlahe (len pri všetkých "+2xLED" verziách)
- **progressívna elektronická jednotka**
- **LONGLIFE LiFePo4 batéria**
- **Inštalovaný mód** (ochrana batérie, pozri aj str.51+88)
- **Inteligentné nabíjanie batérie** ("intermittent" nabíjanie, pozri aj str.51+88)
- **DIP prepínač** umožňujúci prednastavenie funkcií:
 - **ECO Mód** (stmievanie 10%-100%, pozri aj str.51+88)
 - **ENERGY Saving Mód** (osvetlenie pikto na 2cd/m² alebo 200cd/m², pozri str.51+88)
 - ovládanie **2 spodných LED** (zap/vyp počas normálneho režimu 230V)
- špeciálne vrstvené plexi pre perfektné rovnomerné osvetlenie piktoqramu
- adresovateľný CENTRALTEST komunikačný modul (len pre ATXL, ATXP verzie)
- signalizácia LED a TEST tlačítko



Optional end cap with cable entry holes
Príplatkové bočné čelíčky s prechodkami
(look up also page No.94)



Accessory: Diffuser in AL Frame+Legend
Príplatkový kryt svietidla v AL ráme+pikto
(look up also page No.94)

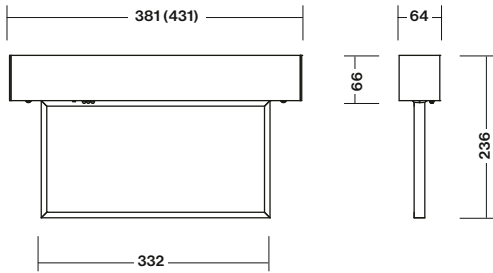

* Dimensions in the bracket are valid for all "APA, APB" versions
 * rozmery v zátvorke platia pre všetky "APA, APB" verzie

Escape route illumination by 2 additional HighPower LEDs

- version APA for corridor application Escape Route illumination
- version APB for open area application Anti Panic Lighting

Anti-panik osvetlenie prídavnými 2xHighPower LED

- verzia APA pre aplikáciu pre koridor / Escape Route
- verzia APB pre aplikáciu v otvorenom priestore "anti-panik"

1LX SPACING TABLE / ROZMIESTNENIE PRE 1LX

H (m)	Y1 (m)	Y2 (m)
2,75	6,6	17,5
3,00	6,1	17,9
3,50	5,7	18,0
4,00	4,7	17,5
4,50	3,5	17,1

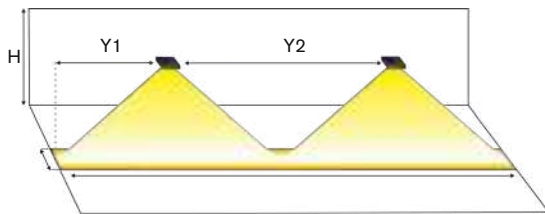

1LX SPACING TABLE / ROZMIESTNENIE PRE 1LX

H (m)	X1 (m)	X2 (m)	Y1 (m)	Y2 (m)
2,75	4,0	10,5	3,0	9,6
3,00	3,1	11,3	2,3	9,8

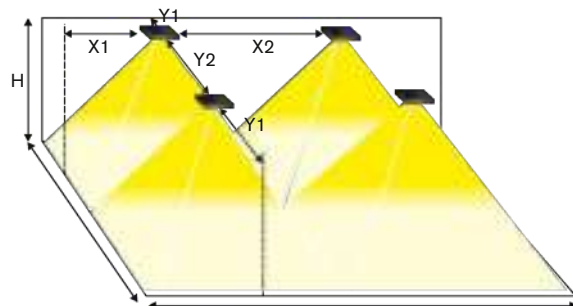

- Optional Wire rope suspension set (for the Item No. look up page No.94)
- Priplatkový lankový závesný set (pre obj.kód pozri str. 94)



MULTIPRIMA-APA+2xLED



MULTIPRIMA-APB+2xLED



- Diffuser in AL frame including legend in accordance with ISO7010
- **It is not included in standard package. It must be ordered as separate item !**
- Viewing Distance 30m
- Legend luminance: >500cd/m² (white)
- kryt svetidla v AL ráme s piktogramom v súlade s ISO7010
- **nie je súčasťou štandardného balenia svetidla, musí byť objednané ako samostatná položka !**
- rozoznatelnosť piktogramu 30m
- jas piktogramu: >500cd/m² (biela)



Item / Položka	Order Code / Objednávaci kód
Single sided diffuser with legend "H" Jednostranný kryt s pikto typ "H"	295-B-000-020-00-00
Single sided diffuser with legend "I" Jednostranný kryt s pikto typ "I"	295-B-000-021-00-00
Single sided diffuser with legend "J" Jednostranný kryt s pikto typ "J"	295-B-000-022-00-00
Single sided diffuser with legend "O" Jednostranný kryt s pikto typ "O"	295-B-000-023-00-00
Single sided diffuser with legend "K" Jednostranný kryt s pikto typ "K"	295-B-000-024-00-00
Single sided diffuser with legend "L" Jednostranný kryt s pikto typ "L"	295-B-000-025-00-00
Single sided diffuser with legend "M" Jednostranný kryt s pikto typ "M"	295-B-000-026-00-00
Single sided diffuser with legend "N" Jednostranný kryt s pikto typ "N"	295-B-000-027-00-00
Double sided diffuser with legend "H/J" Obojstranný kryt s pikto typ "H/J"	295-B-000-028-00-00
Double sided diffuser with legend "I" Obojstranný kryt s pikto typ "I"	295-B-000-029-00-00
Double sided diffuser with legend "O" Obojstranný kryt s pikto typ "O"	295-B-000-030-00-00
Double sided diffuser with legend "K/M" Obojstranný kryt s pikto typ "K/M"	295-B-000-031-00-00
Double sided diffuser with legend "L/N" Obojstranný kryt s pikto typ "L/N"	295-B-000-032-00-00



Options: / Priplatky:

- Wire rope suspension set including all:
 - 2pcs of tool-free adjustable wire holders located on the fixture body for rapid mounting and adjustment of suspension length
 - 2pcs of suspension steel wire ropes 0.8m long
 - 1pc of ceiling power outlets + 1.5m long cord
- End cap with cable entry holes
- Závesný lankový set obsahuje:
 - 2ks nastaviteľných závesov pre nastavenie požadovanej dĺžky závesu
 - 2ks závesných laniek dĺžky 0,8m
 - 1ks sieťovej prípojnej krabičky na strop + číry prívodný elektrický kábel 1,5m dlhý
- Bočné čelíčko s prechodkami pre kabeľaž zo strany

Optional Item / Priplatok	Order Code / objednávaci kód
Wire rope suspension kit 1.5 m long Závesná lanková sada dĺžky 1,5 m	295-B-206-001-00-00
End cap with cable entry holes Bočné čelíčko s prechodkami pre kabeľaž z boku	295-B-207-001-00-00

Page No.32

AUTOTEST -AT NM/M

Type	Version	Duration	Light Source	Light Flux/Emerg.mode	Battery	Order Code	Weight
MULTIPRIMA-AP-AT.1h	NM/M	1h	MidPower LEDs	N.A.	LiFePo4 6,4V/1,0Ah	295-B-300-04-00-00	1,6 kg
MULTIPRIMA-AP-AT.3h	NM/M	3h	MidPower LEDs	N.A.	LiFePo4 6,4V/2,0Ah	295-B-301-04-00-00	1,7 kg
MULTIPRIMA-APA-AT+2xLED.1h	NM/M	1h	MidP LEDs+2x LEDs	- / 100 lm	LiFePo4 6,4V/1,0Ah	295-B-302-04-00-00	1,7 kg
MULTIPRIMA-APA-AT+2xLED.3h	NM/M	3h	MidP LEDs+2x LEDs	- / 100 lm	LiFePo4 6,4V/2,0Ah	295-B-303-04-00-00	1,7 kg
MULTIPRIMA-APB-AT+2xLED.1h	NM/M	1h	MidP LEDs+2x LEDs	- / 100 lm	LiFePo4 6,4V/1,0Ah	295-B-304-04-00-00	1,7 kg
MULTIPRIMA-APB-AT+2xLED.3h	NM/M	3h	MidP LEDs+2x LEDs	- / 100 lm	LiFePo4 6,4V/2,0Ah	295-B-305-04-00-00	1,7 kg

DALI Self-Contained

Type	Version	Duration	Light Source	Light Flux	Battery	Order Code	Weight
MULTIPRIMA-AP-DALI.1h	NM/M	1h	MidPower LEDs	N.A.	LiFePo4 6,4V/1,0Ah	295-B-327-04-00-00	1,6 kg
MULTIPRIMA-AP-DALI.3h	NM/M	3h	MidPower LEDs	N.A.	LiFePo4 6,4V/2,0Ah	295-B-328-04-00-00	1,6 kg

Page No.36

CENTRALTEST -ATXL ELMAX-LOOK

Type	Version	Duration	Light Source	Light Flux/Emerg.mode	Battery	Order Code	Weight
MULTIPRIMA-AP-ATXL.1h	NM/M	1h	18xMidPower LEDs	N.A.	LiFePo4 6,4V/1,0Ah	295-B-306-04-00-00	1,6 kg
MULTIPRIMA-AP-ATXL.3h	NM/M	3h	18xMidPower LEDs	N.A.	LiFePo4 6,4V/2,0Ah	295-B-307-04-00-00	1,7 kg
MULTIPRIMA-APA-ATXL+2xLED.1h	NM/M	1h	MidP LEDs+2x LEDs	- / 100 lm	LiFePo4 6,4V/1,0Ah	295-B-308-04-00-00	1,7 kg
MULTIPRIMA-APA-ATXL+2xLED.3h	NM/M	3h	MidP LEDs+2x LEDs	- / 100 lm	LiFePo4 6,4V/2,0Ah	295-B-309-04-00-00	1,8 kg
MULTIPRIMA-APB-ATXL+2xLED.1h	NM/M	1h	MidP LEDs+2x LEDs	- / 100 lm	LiFePo4 6,4V/1,0Ah	295-B-310-04-00-00	1,7 kg
MULTIPRIMA-APB-ATXL+2xLED.3h	NM/M	3h	MidP LEDs+2x LEDs	- / 100 lm	LiFePo4 6,4V/2,0Ah	295-B-311-04-00-00	1,8 kg

Page No.38

Wireless CENTRALTEST ELMAX-ATRF

Type	Version	Duration	Light Source	Light Flux	Battery	Order Code	Weight
MULTIPRIMA-AP-ATRF.1h	NM/M	1h	MidPower LEDs	N.A.	LiFePo4 6,4V/1,0Ah	295-B-312-04-00-00	1,6 kg
MULTIPRIMA-AP-ATRF.3h	NM/M	3h	MidPower LEDs	N.A.	LiFePo4 6,4V/2,0Ah	295-B-313-04-00-00	1,7 kg
MULTIPRIMA-APA-ATRF+2xLED.1h	NM/M	1h	MidP LEDs+2x LEDs	- / 100 lm	LiFePo4 6,4V/1,0Ah	295-B-314-04-00-00	1,7 kg
MULTIPRIMA-APA-ATRF+2xLED.3h	NM/M	3h	MidP LEDs+2x LEDs	- / 100 lm	LiFePo4 6,4V/2,0Ah	295-B-315-04-00-00	1,8 kg
MULTIPRIMA-APB-ATRF+2xLED.1h	NM/M	1h	MidP LEDs+2x LEDs	- / 100 lm	LiFePo4 6,4V/1,0Ah	295-B-316-04-00-00	1,7 kg
MULTIPRIMA-APB-ATRF+2xLED.3h	NM/M	3h	MidP LEDs+2x LEDs	- / 100 lm	LiFePo4 6,4V/2,0Ah	295-B-317-04-00-00	1,8 kg

Page No.44

CENTRAL BATTERY (CBS)

Type	Version	Light Source	Light Flux	Order Code	Weight
C.PRIMALUX-AP 230V AC/DC	CBS NON-ADDRESSABLE	18xMidPower LEDs	N.A.	295-B-318-00-00-00	1,3 kg
C.PRIMALUX-AP 24V AC/DC	CBS NON-ADDRESSABLE	18xMidPower LEDs	N.A.	295-B-319-00-00-00	1,3 kg
C.PRIMALUX-APA+2xLED 230V AC/DC	CBS NON-ADDRESSABLE	MidPower LEDs+2x LEDs	100 lm	295-B-320-00-00-00	1,4 kg
C.PRIMALUX-APA+2xLED 24V AC/DC	CBS NON-ADDRESSABLE	MidPower LEDs+2x LEDs	100 lm	295-B-321-00-00-00	1,4 kg
C.PRIMALUX-APB+2xLED 230V AC/DC	CBS NON-ADDRESSABLE	MidPower LEDs+2x LEDs	100 lm	295-B-322-00-00-00	1,4 kg
C.PRIMALUX-APB+2xLED 24V AC/DC	CBS NON-ADDRESSABLE	MidPower LEDs+2x LEDs	100 lm	295-B-323-00-00-00	1,4 kg

DALI CENTRAL BATTERY (CBS)

Type	Version	Light Source	Light Flux	Order Code	Weight
C.PRIMALUX-AP-DALI 230V AC	DALI CBS	MidPower LEDs	N.A.	295-B-329-00-00-00	1,3 kg

Page No.40

Addressable CENTRAL BATTERY (CBS) -ATXP ELMAX-PATROLUX

Type	Version	Light Source	Light Flux	Order Code	Weight
C.PRIMALUX-AP-ATXPR 230V AC/DC	ATXP CBS ADDRESSABLE	MidPower LEDs	N.A.	295-B-324-00-00-00	1,4 kg
C.PRIMALUX-APA-ATXPR+2xLED 230V AC/DC	ATXP CBS ADDRESSABLE	MidPower LEDs	100 lm	295-B-325-00-00-00	1,5 kg
C.PRIMALUX-APB-ATXPR+2xLED 230V AC/DC	ATXP CBS ADDRESSABLE	MidP LEDs+2x LEDs	100 lm	295-B-326-00-00-00	1,5 kg

Look up pages No. 210-217 for 1lx Spacing tables
Pozri str.210-217 pre rozmiestnenie svetidiel na dosiahnutie 1lx



Light source	LED 5000K >500cd/m ² (white luminance) >200cd/m ² (average luminance)
Installed load	5.8W/6.1VA (maintained M) 2.0W/3.9VA (non-maintained NM) 6.1W/6.3VA (CBS)
Frame cover material	Anodised aluminum
Viewing distance	30m
Application	Escape route lighting
Max luminaire spacing	up to 18m > 1lx
Application	Anti-panic lighting
Max room illumination	up to 86m² > 0.5lx

Light source	LED 5000K >500cd/m ² (white luminance) >200cd/m ² (average luminance)
Installed load	5.8W/6.1VA (maintained M) 2.0W/3.9VA (non-maintained NM) 6.1W/6.3VA (CBS)
Frame cover material	Anodised aluminum
Viewing distance	30m
Application	Escape route lighting
Max luminaire spacing	up to 18m > 1lx
Application	Anti-panic lighting
Max room illumination	up to 86m² > 0.5lx



RECESSED MOUNTING WITH SUSPENDED LEGEND PRIMALUX



← → 30m

MULTIPRIMA-AV



← → 30m

MULTIPRIMA-AVB+2xLED

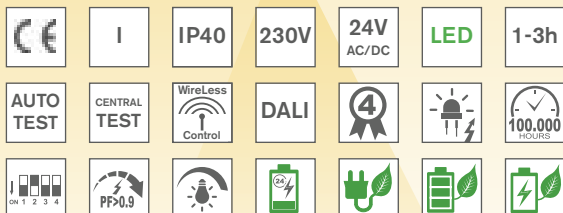

Input Power:

- 5,8W/ 6,1VA (maintained M)
- 2,0W/ 3,9VA (non-maintained NM)
- 6,1W/ 6,3VA (CBS)

Available in black RAL9005 colour

Order code on demand

Dostupné aj v čiernej farbe RAL9005

obj.kód na požiadanie

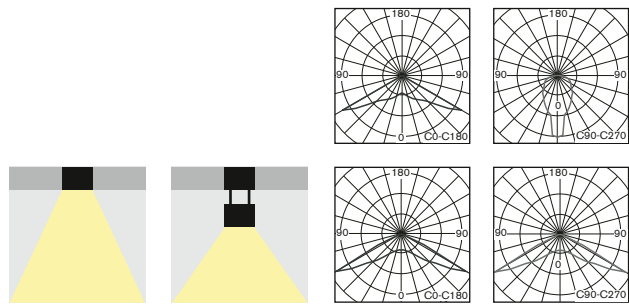

- Exclusive slim design doublesided recessed mounted fixture for non-maintained/ maintained (NM/M) or centralised (C) emergency lighting available in all following versions:

- **AUTOTEST** (-AT)
- **DALI**
- **CENTRALTEST** (-ATXL) for ELMAX LOOK system (look up also page No.36)
- **Wireless CENTRALTEST** (-ATRF) for ELMAX-ATRF system (page No.38)
- **CENTRAL BATTERY** (C.PRIMALUX) for **non-addressable CBS** (page 44)
- **CENTRAL BATTERY** (-ATXP) for system **ELMAX-PATROLUX & Addressable CBS** (look up also page No.40)

- Conforming to the requirement of EN60598-2-22, EN1838, EN62034

Design:

- Anodised AL profile base
- Acrylic layered diffuser with legend in anodised AL frame

- Elegantly "štíhle" obojstranné stropné zapustené núdzové svetidlo pre netrvalé/trvalé (NM/M) alebo (C) centrálné napájané núdzové osvetlenie dostupné vo verziách:

- **AUTOTEST** (-AT)
- **DALI**
- **CENTRALTEST** (-ATXL) pre systém ELMAX LOOK (pozri str.36)
- **bezdrôtový CENTRALTEST** (-ATRF) pre ELMAX-ATRF systém (str.38)
- **CENTRAL BATTERY** (C.PRIMALUX) pre **neadresovateľné CBS** (str.44)
- **CENTRAL BATTERY** (-ATXP) pre systém **ELMAX-PATROLUX s adresovateľnou CBS** (pozri str. 40)

- spĺňa požiadavky európskej normy EN 60598-2-22, EN1838, EN62034

konštrukcia:

- základňa z eloxovaného hliníkového profilu
- svetelno-činný kryt z vrstveného plexi v ráme z eloxovaného hliníku

STANDARD FEATURES

ŠTANDARDNÁ VÝBAVA

- **High efficient (150lm/W, 5000K) LONGLIFE LEDs (>100.000h)**
- **2pcs of High-Power bottom LEDs** 120lm/W for floor escape root illumination (valid only for all "+2xLED" versions)
- **NEW Advanced Electronics**
- **LONGLIFE LiFePo4 battery**
- **Installation Mode** (battery protection, for more details look up page No.51+88)
- **Intelligent battery charging** (intermittent charging, look up page No.51+88)
- **DIP Switch** allowing to preset following functions:
 - **ECO Mode** (dimming 10%-100%, for more details look up page No.51+88)
 - **ENERGY Saving Mode** (picto illumination 2cd/m² or 200cd/m², look up pages 51+88)
 - **2 bottom LEDs control** (ON/OFF during operation on mains 230V, pages 51+88)
- Special layered diffuser for perfect smooth pictogram illumination
- Addressable CENTRALTEST communication module (for ATXL, ATXP only)
- LEDs indicating presence of power supply and signaling failures & TEST button
- **vysoko účinné LED (150lm/W, 5000K) so životnosťou min.100000h**
- **2 výkonné LED 120lm/W pre osvetlenie únikovej cesty na podlahe** (len pri všetkých "+2xLED" verziách)
- **progresívna elektronická jednotka**
- **LONGLIFE LiFePo4 batéria**
- **Inštaláčny mód** (ochrana batérie, pozri aj str.51+88)
- **Inteligentné nabíjanie batérie** ("intermittent" nabíjanie, pozri aj str.51+88)
- **DIP prepínač** umožňujúci prednastavenie funkcií:
 - **ECO Mód** (stmievanie 10%-100%, pozri aj str.51+88)
 - **ENERGY Saving Mód** (osvetlenie pikto na 2cd/m² alebo 200cd/m², pozri str.51+88)
 - ovládanie **2 spodných LED** (zap/vyp počas normálneho režimu 230V)
- špeciálne vrstvené plexi pre perfektné rovnomerné osvetlenie piktoqramu
- adresovateľný CENTRALTEST komunikačný modul (len pre ATXL, ATXP verzie)
- signalizácia LED a TEST tlačítko



Optional Wire Rope Suspension
Príplatkový lankový záves 2m
(look up also page No.99)



Accessory: Diffuser in AL Frame & Legend
Príplatkový kryt svetidla v AL ráme+pikto
(look up also page No.99)

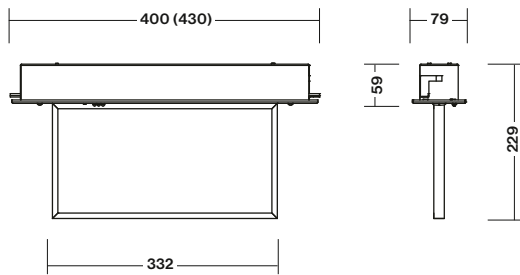

* Dimensions in the bracket are valid for all "AVA, AVB" versions
 * rozmery v zátvorke platia pre všetky "AVA, AVB" verzie



Recessed mounting hole size for all -AVA/-AVB versions: **400x60 mm**
 Rozmer montážneho otvoru pre verzie -AVA/-AVB: **400x60 mm**

Recessed mounting hole size for all -AVA/-AVB +2xLED versions: **430x60 mm**
 Rozmer montážneho otvoru pre verzie -AVA/-AVB +2xLED: **430x60 mm**

Escape route illumination by 2 additional HighPower LEDs

- version APA for corridor application Escape Route illumination
- version APB for open area application Anti Panic Lighting

Anti-panik osvetlenie prídavnými 2xHighPower LED

- verzia APA pre aplikáciu pre koridor / Escape Route
- verzia APB pre aplikáciu v otvorenom priestore "anti-panik"

1LX SPACING TABLE / ROZMIESTNENIE PRE 1LX

H (m)	Y1 (m)	Y2 (m)
2,75	6,6	17,5
3,00	6,1	17,9
3,50	5,7	18,0
4,00	4,7	17,5
4,50	3,5	17,1

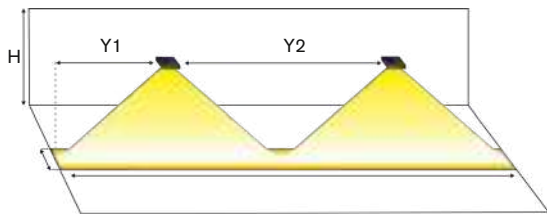

1LX SPACING TABLE / ROZMIESTNENIE PRE 1LX

H (m)	X1 (m)	X2 (m)	Y1 (m)	Y2 (m)
2,75	4,0	10,5	3,0	9,6
3,00	3,1	11,3	2,3	9,8

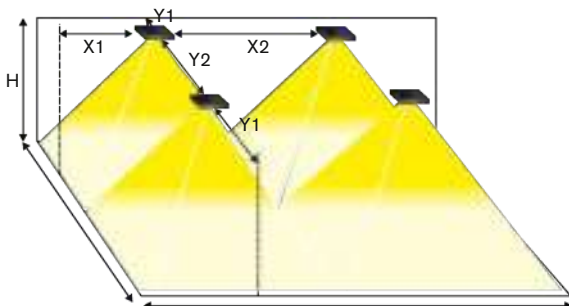

- Optional Wire rope suspension set (for the Item No. look up page No.99)
- Príplatkový lankový závesný set (pre obj.kód pozri str. 99)



MULTIPRIMA-AVA+2xLED



MULTIPRIMA-AVB+2xLED

ACCESSORIES PRIMALUX



- Diffuser in AL frame including legend in accordance with ISO7010
- **It is not included in standard package. It must be ordered as separate item !**

- Viewing Distance: 30m
- Legend luminance >500cd/m² (white)

- kryt svetidla v AL ráme s piktoqramom v súlade s ISO7010
- **nie je súčasťou štandardného balenia svetidla, musí byť objednané ako samostatná položka !**
- rozoznatelnosť piktoqramu: 30m
- jas piktoqramu >500cd/m² (biela)



Item / Položka	Order Code / Objednávací kód
Single sided diffuser with legend "H" Jednostranný kryt s pikto typ "H"	295-B-000-020-00-00
Single sided diffuser with legend "I" Jednostranný kryt s pikto typ "I"	295-B-000-021-00-00
Single sided diffuser with legend "J" Jednostranný kryt s pikto typ "J"	295-B-000-022-00-00
Single sided diffuser with legend "O" Jednostranný kryt s pikto typ "O"	295-B-000-023-00-00
Single sided diffuser with legend "K" Jednostranný kryt s pikto typ "K"	295-B-000-024-00-00
Single sided diffuser with legend "L" Jednostranný kryt s pikto typ "L"	295-B-000-025-00-00
Single sided diffuser with legend "M" Jednostranný kryt s pikto typ "M"	295-B-000-026-00-00
Single sided diffuser with legend "N" Jednostranný kryt s pikto typ "N"	295-B-000-027-00-00
Double sided diffuser with legend "H/J" Obojstranný kryt s pikto typ "H/J"	295-B-000-028-00-00
Double sided diffuser with legend "I" Obojstranný kryt s pikto typ "I"	295-B-000-029-00-00
Double sided diffuser with legend "O" Obojstranný kryt s pikto typ "O"	295-B-000-030-00-00
Double sided diffuser with legend "K/M" Obojstranný kryt s pikto typ "K/M"	295-B-000-031-00-00
Double sided diffuser with legend "L/N" Obojstranný kryt s pikto typ "L/N"	295-B-000-032-00-00

Available in black RAL9005 colour

Order code on demand

Dostupné aj čiernej farbe RAL9005

obj.kód ba požiadanie

Options: / Príplatky:

- Wire rope suspension set including all:
 - 2pcs of tool-free adjustable wire holders located on the fixture body for rapid mounting and adjustment of suspension length
 - 2pcs of suspension steel wire ropes 0.8m long
 - 1pc of ceiling power outlets
 - 1.5m long cord

• Závesný lankový set obsahuje:

- 2ks nastaviteľných závesov pre nastavenie požadovanej dĺžky závesu
- 2ks závesných laniek dĺžky 0,8m
- 1ks sieťovej prípojnej krabičky na strop
- číry prírodný elektrický kábel 1,5m dlhý

Optional Item / Príplatok	Order Code / objednávací kód
Wire rope suspension kit 1.5 m long	295-B-206-001-00-00
Závesná lanková sada dĺžky 1,5 m	295-B-206-001-00-00



Page No.32

AUTOTEST -AT NM/M

Type	Version	Duration	Light Source	Light Flux / Emerg.mode	Battery	Order Code	Weight
MULTIPRIMA-AV-AT.1h	NM/M	1h	MidPower LEDs	N.A.	LiFePo4 6,4V/1,0Ah	295-B-400-04-00-00	1,6 kg
MULTIPRIMA-AV-AT.3h	NM/M	3h	MidPower LEDs	N.A.	LiFePo4 6,4V/2,0Ah	295-B-401-04-00-00	1,7 kg
MULTIPRIMA-AVA-AT+2xLED.1h	NM/M	1h	MidPwr LED+2x LED	- / 100 lm	LiFePo4 6,4V/1,0Ah	295-B-402-04-00-00	1,7 kg
MULTIPRIMA-AVA-AT+2xLED.3h	NM/M	3h	MidPwr LED+2x LED	- / 100 lm	LiFePo4 6,4V/2,0Ah	295-B-403-04-00-00	1,8 kg
MULTIPRIMA-AVB-AT+2xLED.1h	NM/M	1h	MidPwr LED+2x LED	- / 100 lm	LiFePo4 6,4V/1,0Ah	295-B-404-04-00-00	1,7 kg
MULTIPRIMA-AVB-AT+2xLED.3h	NM/M	3h	MidPwr LED+2x LED	- / 100 lm	LiFePo4 6,4V/2,0Ah	295-B-405-04-00-00	1,8 kg

DALI Self-Contained

Type	Version	Duration	Light Source	Light Flux	Battery	Order Code	Weight
MULTIPRIMA-AV-DALI.1h	NM/M	1h	MidPower LEDs	N.A.	LiFePo4 6,4V/1,0Ah	295-B-427-04-00-00	1,6 kg
MULTIPRIMA-AV-DALI.3h	NM/M	3h	MidPower LEDs	N.A.	LiFePo4 6,4V/2,0Ah	295-B-428-04-00-00	1,6 kg

Page No.36

CENTRALTEST -ATXL ELMAX-LOOK

Type	Version	Duration	Light Source	Light Flux/Emerg.mode	Battery	Order Code	Weight
MULTIPRIMA-AV-ATXL.1h	NM/M	1h	MidPower LEDs	N.A.	LiFePo4 6,4V/1,0Ah	295-B-406-04-00-00	1,6 kg
MULTIPRIMA-AV-ATXL.3h	NM/M	3h	MidPower LEDs	N.A.	LiFePo4 6,4V/2,0Ah	295-B-407-04-00-00	1,7 kg
MULTIPRIMA-AVA-ATXL+2xLED.1h	NM/M	1h	MidPwr LED+2x LED	- / 100 lm	LiFePo4 6,4V/1,0Ah	295-B-408-04-00-00	1,7 kg
MULTIPRIMA-AVA-ATXL+2xLED.3h	NM/M	3h	MidPwr LED+2x LED	- / 100 lm	LiFePo4 6,4V/2,0Ah	295-B-409-04-00-00	1,8 kg
MULTIPRIMA-AVB-ATXL+2xLED.1h	NM/M	1h	MidPwr LED+2x LED	- / 100 lm	LiFePo4 6,4V/1,0Ah	295-B-410-04-00-00	1,7 kg
MULTIPRIMA-AVB-ATXL+2xLED.3h	NM/M	3h	MidPwr LED+2x LED	- / 100 lm	LiFePo4 6,4V/2,0Ah	295-B-411-04-00-00	1,8 kg

Page No.38

Wireless CENTRALTEST ELMAX-ATRF

Type	Version	Duration	Light Source	Light Flux	Battery	Order Code	Weight
MULTIPRIMA-AV-ATRF.1h	NM/M	1h	MidPower LEDs	N.A.	LiFePo4 6,4V/1,0Ah	295-B-412-04-00-00	1,6 kg
MULTIPRIMA-AV-ATRF.3h	NM/M	3h	MidPower LEDs	N.A.	LiFePo4 6,4V/2,0Ah	295-B-413-04-00-00	1,7 kg
MULTIPRIMA-AVA-ATRF+2xLED.1h	NM/M	1h	MidPwr LED+2x LED	- / 100 lm	LiFePo4 6,4V/1,0Ah	295-B-414-04-00-00	1,7 kg
MULTIPRIMA-AVA-ATRF+2xLED.3h	NM/M	3h	MidPwr LED+2x LED	- / 100 lm	LiFePo4 6,4V/2,0Ah	295-B-415-04-00-00	1,8 kg
MULTIPRIMA-AVB-ATRF+2xLED.1h	NM/M	1h	MidPwr LED+2x LED	- / 100 lm	LiFePo4 6,4V/1,0Ah	295-B-416-04-00-00	1,7 kg
MULTIPRIMA-AVB-ATRF+2xLED.3h	NM/M	3h	MidPwr LED+2x LED	- / 100 lm	LiFePo4 6,4V/2,0Ah	295-B-417-04-00-00	1,8 kg

Page No.44

CENTRAL BATTERY (CBS)

Type	Version	Light Source	Light Flux	Order Code	Weight
C.PRIMALUX-AV 230V AC/DC	CBS NON-ADDRESSABLE	MidPower LEDs	N.A.	295-B-418-00-00-00	1,3 kg
C.PRIMALUX-AV 24V AC/DC	CBS NON-ADDRESSABLE	MidPower LEDs	N.A.	295-B-419-00-00-00	1,3 kg
C.PRIMALUX-AVA+2xLED 230V AC/DC	CBS NON-ADDRESSABLE	MidPower LEDs+2x LEDs	100 lm	295-B-420-00-00-00	1,4 kg
C.PRIMALUX-AVA+2xLED 24V AC/DC	CBS NON-ADDRESSABLE	MidPower LEDs+2x LEDs	100 lm	295-B-421-00-00-00	1,4 kg
C.PRIMALUX-AVB+2xLED 230V AC/DC	CBS NON-ADDRESSABLE	MidPower LEDs+2x LEDs	100 lm	295-B-422-00-00-00	1,4 kg
C.PRIMALUX-AVB+2xLED 24V AC/DC	CBS NON-ADDRESSABLE	MidPower LEDs+2x LEDs	100 lm	295-B-423-00-00-00	1,4 kg

DALI CENTRAL BATTERY (CBS)

Type	Version	Light Source	Light Flux	Order Code	Weight
C.PRIMALUX-AV-DALI 230V AC	DALI CBS	MidPower LEDs	N.A.	295-B-429-00-00-00	1,3 kg

Page No.40

Addressable CENTRAL BATTERY (CBS) -ATXP ELMAX-PATROLUX

Type	Version	Light Source	Light Flux	Order Code	Weight
C.PRIMALUX-AV-ATXPR 230V AC/DC	ATXP CBS ADDRESSABLE	MidPower LEDs	N.A.	295-B-424-00-00-00	1,4 kg
C.PRIMALUX-AVA-ATXPR+2xLED 230V AC/DC	ATXP CBS ADDRESSABLE	MidPwr LED+2x LED	100 lm	295-B-425-00-00-00	1,5 kg
C.PRIMALUX-AVB-ATXPR+2xLED 230V AC/DC	ATXP CBS ADDRESSABLE	MidPwr LED+2x LED	100 lm	295-B-426-00-00-00	1,5 kg

Look up pages No. 210-217 for 1lx Spacing tables
Pozri str.210-217 pre rozmiestnenie svetidiel na dosiahnutie 1lx

FALCON-P /-V



FALCON-P



FALCON-V

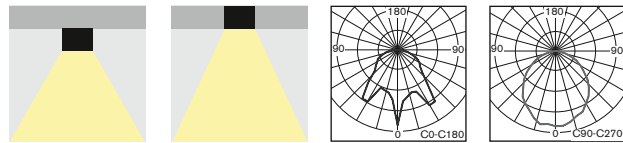

- Exclusive design orientated ceiling mounted fixture for 2IN1 function: antipanic & escape route sign in one fixture
- Available either for surface ceiling mounting (all "-P" versions) or for recessed mounting (all "-V" versions)
- Either non-maintained/ maintained (NM/M) or centralised (C) emergency lighting available in all following versions:
 - **AUTOTEST (-AT) or DALI**
 - **CENTRALTEST (-ATXL)** for ELMAX LOOK system (look up also page No.36)
 - **Wireless CENTRALTEST (-ATRF)** for ELMAX-ATRF system (page No.38)
 - **CENTRAL BATTERY (C.PRIMALUX)** for **non-addressable CBS** (look up also page No.44)
 - **CENTRAL BATTERY (-ATXP)** for system **ELMAX-PATROLUX & Addressable CBS** (look up also page No.40)
- Conforming to the requirement of EN60598-2-22, EN1838, EN62034
- Design:
 - Anodised AL profile base
 - PC diffuser
- Elegatné stropné núdzové svietidlo pre stropnú montáž (všetky "-P" verzie) alebo zapustenú montáž do stropu (všetky "-V" verzie)
- 2v1 dizajn, tj antipanic svietidlo a núdzové svietidlo s piktogramom v jednom
- Pre netrvalé/trvalé (NM/M) alebo (C) centrálné napájané núdzové osvetlenie dostupné vo verziách:
 - **AUTOTEST (-AT)** alebo **DALI**
 - **CENTRALTEST (-ATXL)** pre systém ELMAX LOOK (pozri str.36)
 - **bezdrôtový CENTRALTEST (-ATRF)** pre ELMAX-ATRF systém (str.38)
 - **CENTRAL BATTERY (C.PRIMALUX)** pre **neadresovateľné CBS** (str.44)
 - **CENTRAL BATTERY (-ATXP)** pre systém **ELMAX-PATROLUX s adresovateľnou CBS** (pozri str. 40)
- spĺňa požiadavky európskej normy EN 60598-2-22, EN1838, EN62034
- konštrukcia:
 - základňa z eloxovaného hliníkového profilu
 - svetelno-činný kryt z polykarbonátu

STANDARD FEATURES

STANDARDNÁ VÝBAVA

- **High efficient (150lm/W, 5000K) LONGLIFE LEDs (>100.000h)**
- **NEW Advanced Electronics**
- **LONGLIFE LiFePo4 battery**
- **Installation Mode** (battery protection, for more details look up page No.51+102)
- **Intelligent battery charging** (intermittent charging, look up page No.51+102)
- **DIP Switch** allowing to preset following functions:
 - **ECO Mód** (dimming 10%-100%, for more details look up page No.51+102)
 - **ENERGY Saving Mode** (picto illumination 2cd/m² or 200cd/m², look up page 102)
- Special layered suspended legend for perfect smooth pictogram illumination
- Addressable CENTRALTEST communication module (for ATXL, ATXP, ATRF only)
- LEDs indicating presence of power supply and signaling failures & TEST button
- **vysoko účinné LED (150lm/W, 5000K) so životnosťou min.100000h**
- **progressívna elektronická jednotka**
- **LONGLIFE LiFePo4 batéria**
- **Inštalčný mód** (ochrana batérie, pozri aj str.51+102)
- **Inteligentné nabíjanie batérie** ("intermittent" nabíjanie, pozri aj str.51+102)
- **DIP prepínač** umožňujúci prednastavenie funkcií:
 - **ECO Mód** (stmievanie 10%-100%, pozri aj str.51+102)
 - **ENERGY Saving Mód** (osvetlenie pikto na 2cd/m² alebo 200cd/m², pozri aj str.102)
- špeciálne vrstvené závesné plexi pre perfektné rovnomerné osvetlenie piktogramu
- adresovateľný CENTRALTEST komunikačný modul (len pre ATXL, ATXP, ATRF verzie)
- signalizácia LED a TEST tlačítko

OPTIONAL ACCESSORIES

PRÍPLATKY

- **Special suspended plexi with layered design for perfect uniform illumination of legend - must be ordered as a separate item (look up also page No.104)**
- Wall or ceiling mounting brackets (look up also page No.104)
- Wire rope suspension set (look up also page No.104)
- Alternative colour surface treatment in RAL (min order quantity 50pcs)
- **špeciálne vrstvené závesné plexi pre rovnomerné osvetlenie piktogramu na jeho celej ploche (plexi musí byť objednané samostatne podľa želaného piktogramu- pozri aj str.104)**
- nástenná, stropná alebo stropná závesná konzola (pozri aj str.104)
- lanková závesná sada (pozri aj str.104)
- povrchová úprava vo farbe podľa špecifikácie odberateľa (min 50ks)



Input Power:

- 5,3W/ 5,6VA (maintained M)
- 2,0W/ 3,8VA (non-maintained NM)
- 3,0W/ 5,1VA (CBS)

RECESSED MOUNTING FALCON-V

CEILING MOUNTING WITH SUSPENDED LEGEND FALCON-P



Recessed mounting hole size
for all -V versions: 357x68mm

Rozmer montážneho otvoru
pre verzie -V: 357x68mm

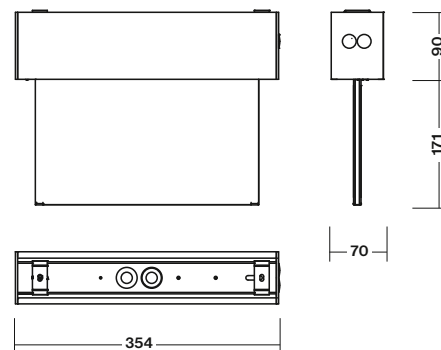
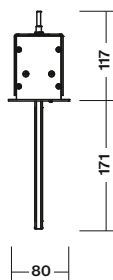
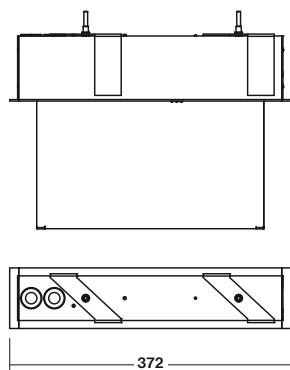

Page No.32

AUTOTEST -AT NM/M

Type	Version	Duration	Light Source	Light Flux/Emerg.mode	Battery	Order Code	Weight
FALCON-P-AT.1h	NM/M	1h	MidPower LEDs	400 lm / 220lm	LiFePo4 6,4V/1,0Ah	333-B-001-04-00-00	1,6 kg
FALCON-P-AT.3h	NM/M	3h	MidPower LEDs	400 lm / 220lm	LiFePo4 6,4V/2,0Ah	333-B-002-04-00-00	1,7 kg
FALCON-V-AT.1h	NM/M	1h	MidPower LEDs	400 lm / 220lm	LiFePo4 6,4V/1,0Ah	333-B-201-04-00-00	1,6 kg
FALCON-V-AT.3h	NM/M	3h	MidPower LEDs	400 lm / 220lm	LiFePo4 6,4V/2,0Ah	333-B-202-04-00-00	1,7 kg

DALI Self-Contained

Type	Version	Duration	Light Source	Light Flux	Battery	Order Code	Weight
FALCON-P-DALI.1h	NM/M	1h	MidPower LEDs	400 lm / 220lm	LiFePo4 6,4V/1,0Ah	333-B-003-04-00-00	1,6 kg
FALCON-V-DALI.1h	NM/M	1h	MidPower LEDs	400 lm / 220lm	LiFePo4 6,4V/1,0Ah	333-B-203-04-00-00	1,6 kg

Page No.36

CENTRALTEST -ATXL ELMAX-LOOK

Type	Version	Duration	Light Source	Light Flux/Emerg.mode	Battery	Order Code	Weight
FALCON-P-ATXL.1h	NM/M	1h	MidPower LEDs	400 lm / 220lm	LiFePo4 6,4V/1,0Ah	333-B-004-04-00-00	1,6 kg
FALCON-P-ATXL.3h	NM/M	3h	MidPower LEDs	400 lm / 220lm	LiFePo4 6,4V/2,0Ah	333-B-005-04-00-00	1,7 kg
FALCON-V-ATXL.1h	NM/M	1h	MidPower LEDs	400 lm / 220lm	LiFePo4 6,4V/1,0Ah	333-B-204-04-00-00	1,6 kg
FALCON-V-ATXL.3h	NM/M	3h	MidPower LEDs	400 lm / 220lm	LiFePo4 6,4V/2,0Ah	333-B-205-04-00-00	1,7 kg

Page No.38

Wireless CENTRALTEST ELMAX-ATRF

Type	Version	Duration	Light Source	Light Flux	Battery	Order Code	Weight
FALCON-P-ATRF.1h	NM/M	1h	MidPower LEDs	400 lm / 220lm	LiFePo4 6,4V/1,0Ah	333-B-006-04-00-00	1,6 kg
FALCON-P-ATRF.3h	NM/M	3h	MidPower LEDs	400 lm / 220lm	LiFePo4 6,4V/2,0Ah	333-B-007-04-00-00	1,7 kg
FALCON-V-ATRF.1h	NM/M	1h	MidPower LEDs	400 lm / 220lm	LiFePo4 6,4V/1,0Ah	333-B-206-04-00-00	1,6 kg
FALCON-V-ATRF.3h	NM/M	3h	MidPower LEDs	400 lm / 220lm	LiFePo4 6,4V/2,0Ah	333-B-207-04-00-00	1,7 kg

Page No.44

CENTRAL BATTERY (CBS)

Type	Version	Light Source	Light Flux	Order Code	Weight
C.FALCON-P 230V AC/DC	CBS NON-ADDRESSABLE	MidPower LEDs	400lm	333-B-008-00-00-00	1,3 kg
C.FALCON-P 24V AC/DC	CBS NON-ADDRESSABLE	MidPower LEDs	400lm	333-B-009-00-00-00	1,3 kg
C.FALCON-V 230V AC/DC	CBS NON-ADDRESSABLE	MidPower LEDs	400lm	333-B-208-00-00-00	1,3 kg
C.FALCON-V 24V AC/DC	CBS NON-ADDRESSABLE	MidPower LEDs	400lm	333-B-209-00-00-00	1,3 kg

DALI CENTRAL BATTERY (CBS)

Type	Version	Light Source	Light Flux	Order Code	Weight
C.FALCON-P-DALI 230V AC/DC	DALI CBS	MidPower LEDs	480lm	333-B-010-00-00-00	1,3 kg
C.FALCON-V-DALI 230V AC/DC	DALI CBS	MidPower LEDs	480lm	333-B-210-00-00-00	1,3 kg

Page No.40

Addressable CENTRAL BATTERY (CBS) -ATXP ELMAX-PATROLUX

Type	Version	Light Source	Light Flux	Order Code	Weight
C.FALCON-P-ATXPR 230V AC/DC	ATXP CBS ADDRESSABLE	MidPower LEDs	400lm	333-B-011-00-00-00	1,4 kg
C.FALCON-V-ATXPR 230V AC/DC	ATXP CBS ADDRESSABLE	MidPower LEDs	400lm	333-B-211-00-00-00	1,4 kg

Look up pages No. 210-217 for 1lx Spacing tables
Pozri str.210-217 pre rozmiestnenie svetidiel na dosiahnutie 1lx



• **It is not included in standard package. It must be ordered as separate item !**

- Viewing Distance: 30m
- Complying ISO7010
- Legend luminance >500cd/m² (white)

• **nie je súčasťou štandardného balenia svietidla, musí byť objednané ako samostatná položka !**

- rozoznateľnosť piktogramu: 30m
- v súlade s ISO7010
- jas piktogramu >500cd/m² (biela)



Plexi Legend / plexi s pikto

Optional Item	Order Code
Double sided plexi H/J / obojstranné pikto H/J	309-B-000-00-00-01
Double sided plexi I / obojstranné pikto I	309-B-000-00-00-02
Single sided plexi H / jednostranné pikto H	309-B-000-00-00-03
Single sided plexi I / jednostranné pikto I	309-B-000-00-00-04
Single sided plexi J / jednostranné pikto J	309-B-000-00-00-05
Double sided plexi K/M / obojstranné pikto K/M	309-B-000-00-00-06
Double sided plexi L/N / obojstranné pikto L/N	309-B-000-00-00-07
Single sided plexi K / jednostranné pikto K	309-B-000-00-00-08
Single sided plexi L / jednostranné pikto L	309-B-000-00-00-09
Single sided plexi M / jednostranné pikto M	309-B-000-00-00-10
Single sided plexi N / jednostranné pikto N	309-B-000-00-00-11
Single sided plexi O / jednostranné pikto O	309-B-000-00-00-12
Double sided plexi O / obojstranné pikto O	309-B-000-00-00-13
Double sided plexi Z1 / obojstranné pikto Z1	309-B-000-00-00-27
Double sided plexi Z2 / obojstranné pikto Z2	309-B-000-00-00-28



Wire rope suspension set RAL9006 colour
Lanková závesná sada v RAL9006 farbe



Optional Item / Príplatky	Order Code
Wire rope suspension set 1,0m long in white RAL9003 colour / lanková závesná sada 1,0m dlhá v bielej RAL9003 farbe	85-B-05-13-01
Wire rope suspension set 1,0m long in grey RAL9006 colour / lanková závesná sada 1,0m dlhá v šedej RAL9006 farbe	85-B-05-13-00
Wire rope suspension set 2,0m long in white RAL9003 colour / lanková závesná sada 2,0m dlhá v bielej RAL9003 farbe	85-B-05-18-00
Wire rope suspension set 2,0m long in grey RAL9006 colour / lanková závesná sada 2,0m dlhá v šedej RAL9006 farbe	85-B-05-60-00



DIP SWITCH FEATURES No.1 DIP PREPÍNAČ č.1 - FUNKCIE SELF-CONTAINED BATTERY VERSIONS

DIP SWITCH FEATURES No.2-4 DIP PREPÍNAČ č.2-4 - FUNKCIE SELF-CONTAINED BATTERY VERSIONS

NORMAL MODE
230V MAINS

EMERGENCY MODE
BATTERY



ESCAPE SIGN Brightness in 230V
OFF = 100%
BRIGHTNESS > 200cd/m²

ECO MODE 10% (in 230V Mode)
ON = 10%
BRIGHTNESS > 2cd/m²

INSTALLATION MODE
SET UP

DEFAULT SETTING / PREDNASTAVENÉ
OFF - ACTIVATED
ON - DEACTIVATED

M / NM
NON-MAINTAINED / MAINTAINED MODE
SET UP

DEFAULT SETTING / PREDNASTAVENÉ
ON - MAINTAINED
OFF - NON-MAINTAINED

AT / ATXL
AUTOTEST / CENTRALTEST MODE
SET UP

DEFAULT SETTING / PREDNASTAVENÉ
OFF - AUTOTEST
ON - CENTRALTEST

TO SEE THE CHANGE PUSH EITHER TEST BUTTON OR DISCONNECT THE FIXTURE FROM BOTH THE MAINS 230V AND BATTERY

Po prestavení stlačte TEST alebo odpojte batériu a 230V napájanie na aktiváciu zmeny

JUMPERS FEATURES JUMPER FUNKCIE CBS CENTRAL BATTERY VERSIONS

There is L1' logical input which allows to control the dimming function of the fixture by presence of 230V on L1'. During the first installation you can preset DIM level either 50% or 40% or 30% or 20% or 10%. The advantage of dimming feature is either energy saving or brightness reduction in e.g.cinema or theatre application.

Svietidlo je vybavené logickým vstupom L1', ktorým je ovládané stmievanie svietidla. Počas prvej inštalácie je možné nastaviť úroveň stmievania na 50% alebo 40% alebo 30% alebo 20% alebo 10%. Táto funkcia prispieva k zníženiu spotreby elektrickej energie alebo môže byť s výhodou použitá v kinách / divadlách, kde je počas predstavenia nežiadúci vysoký jas piktoqramu.

	If 230V presents on L1: Ak je 230V prítomných na L1 :	FULL POWER LEGEND BRIGHTNESS > 200cd/m² JAS PIKTOGRAMU > 200cd/m²
	J9 CLOSE J10,11,12 OPEN	ECO MODE 50%
	J10 CLOSE J9,11,12 OPEN	ECO MODE 40%
	J11 CLOSE J9,10,12 OPEN	ECO MODE 30%
	J12 CLOSE J9,10,11 OPEN	ECO MODE 20%
	J9,10,11,12 OPEN	ECO MODE 10% LEGEND BRIGHTNESS > 2cd/m² JAS PIKTOGRAMU > 2cd/m²

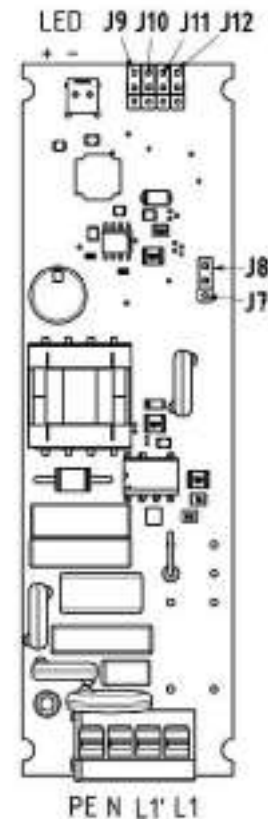

Logic of Dimming:

JUMPER	MAINS INPUT		Lighting Output
J8 - CLOSE (DEFAULT SETTING)	L1	L1'	
	0	0	OFF
	0	1	OFF
	1	0	100%
	1	1	DIMM

JUMPER	MAINS INPUT		Lighting Output
J7 - CLOSE	L1	L2 (L1')	
	0	0	OFF
	0	1	OFF
	1	0	DIMM
	1	1	100%

Dimming options:

JUMPERS				DIMMING LEVEL
J9	J10	J11	J12	
OPEN	OPEN	OPEN	OPEN	10%
OPEN	OPEN	OPEN	CLOSE	20%
OPEN	OPEN	CLOSE	OPEN	30%
OPEN	CLOSE	OPEN	OPEN	40%
CLOSE	OPEN	OPEN	OPEN	50%

DIMM - see Dimming option

PREMIUM LINE LEDLUX2

Transparent acrylic glass and unobtrusive design enhances aesthetic and functional aspects of LEDLUX type series. Thanks to the special layered glass design it achieves perfect uniformity of backlighting. Combined with the qualities of an innovative LED luminaire - extra-long service life at constant light output - this escape sign luminaire boasts a special talent for low operating costs. The luminaire proves its application flexibility with its range of installation options.

Číre závesné plexi a moderný nenápadný design vychádzajúci z kvalitných materiálov prehlbujú estetické a funkčné vlastnosti svietidiel typovej rady LEDLUX. Vďaka špeciálnemu vrstvenému plexi je dosiahnutá perfektná rovnomernosť osvetlenia piktogramu. V kombinácii s kvalitami inovatívneho LED svietidla - extra dlhá životnosť pri konštantnom svetelnom výkone - sa môže toto núdzové svietidlo pochváliť špeciálnym talentom pre nízke prevádzkové a servisné náklady. LEDLUX dokazuje svoju aplikačnú flexibilitu vďaka širokej typovej rade s rôznymi inštalačnými možnosťami.

Light source	LED 5000K
	>500cd/m ² (white luminance)
	>200cd/m ² (average luminance)
Installed load	5.3W/5.6VA (maintained M)
	2.0W/3.8VA (non-maintained NM)
	3.0W/5.1VA (CBS)
Suspended plexi	Layered design with high uniformity
Viewing distance	30m





Available in black RAL9005 colour
Order code on demand
Dostupné aj čiernej RAL9005

Thanks to the advanced design of the suspended plexi diffuser the pictogram is perfectly uniformly illuminated on the whole surface

Vďaka špeciálnej vrstvenej štruktúre závesného plexi je jeho celá plocha perfektne rovnomerne nasvietená po celom povrchu



AUTOTEST/CENTRALTEST
(only all MULTILED-AT/ATXL/ATRF versions):
Monitor status by 3x LEDs and TEST button

AUTOTEST/CENTRALTEST
(len pre všetky MULTILED-AT/ATXL/ATRF):
3x LED pre signalizáciu stavu svietidla a TEST tlačítko

The whole assortment of accessories including all wire rope suspension, ceiling brackets and wall mounting brackets

Široká ponuka príplatkového príslušenstva zahrňujúceho závesné sady, konzoly pre montáž na stenu, resp. závesná konzola na strop



CEILING MOUNTING WITH SUSPENDED LEGEND LEDLUX2-P

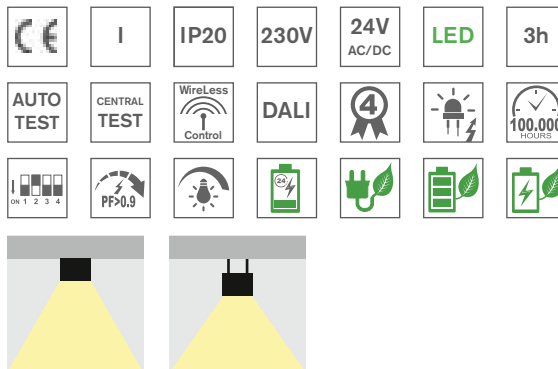

- Modern design orientated **surface mounted LED** non-maintained/maintained (NM/M) or centralised (C) emergency lighting with smooth legend illumination for all **areas such as offices, shops, hotels, banks, entrance halls, schools, hospitals, etc.**

It is available in all following versions:

- **AUTOTEST** (-AT)
- **DALI**
- **CENTRALTEST** (-ATXL) for **ELMAX LOOK** system (look up also page No.36)
- **Wireless CENTRALTEST** (-ATRF) for **ELMAX Wireless** system (page No.38)
- **CENTRAL BATTERY** (C.LEDLUX) for **non-addressable CBS** (look up also page No.44)
- **CENTRAL BATTERY** (-ATXP) for system **ELMAX-PATROLUX & Addressable CBS** (look up also page No.40)
- Legend luminance: >500cd/m² (white)
- Conforming to the requirement of EN60598-2-22, EN1838, EN62034
- Design: metal sheet body with PE powder coat finish RAL9006 (grey), RAL9003 (white) or RAL9005 (black)

- Elegánntné stropné LED svietidlá pre **netrvalé/trvalé (NM/M)** alebo **centrálne (C)** núdzové osvetlenie s perfektnou rovnomernosťou osvetlenia piktogramu **navrhnuté pre všeobecné použitie priestorov ako napr. kancelárie, obchody, školy, nemocnice, vstupné haly, banky a pod.,** aj s funkciami:

- **AUTOTEST** (-AT)
- **DALI**
- **CENTRALTEST** (-ATXL) pre systém ELMAX LOOK (pozri str.36)
- **bezdrôtový CENTRALTEST** (-ATRF) pre ELMAX Wireless systém (pozri str.38)
- **CENTRAL BATTERY** (C.LEDLUX) pre **neadresovateľné CBS** (pozri str.44)
- **CENTRAL BATTERY** (-ATXP) pre systém **ELMAX-PATROLUX s adresovateľnou CBS** (pozri str. 40)

- spĺňa požiadavky európskej normy EN 60598-2-22, EN1838, EN62034
- Jas piktogramu: >500cd/m² (white)
- konštrukcia: teleso z oceľového plechu vo farbe RAL9006 (šedá), RAL9003 (biela) alebo RAL9005 (čierna)

STANDARD FEATURES

STANDARDNÁ VÝBAVA

- **High efficient MidPower (150lm/W, 5000K) LONGLIFE LEDs (>100.000h)**
- **NEW Advanced Electronics**
- **LONGLIFE NiMh or LiFePo4 battery**
- **Installation Mode** (battery protection, for more details look up page No.51+114)
- **Intelligent battery charging** (intermittent charging, look up page No.51+114)
- **DIP Switch** allowing to preset following functions:
 - **ECO Mode** (dimming 10%-100%, for more details look up page No.51+114)
- Addressable CENTRALTEST communication module (for ATXL, ATXP, ATRF only)
- LEDs indicating presence of power supply and signaling failures & TEST button

- **vysoko účinné MidPower LED (150lm/W, 5000K) so životnosťou min.100000h**
- **progresívna elektronická jednotka**
- **LONGLIFE NiMh alebo LiFePo4 batéria**
- **Inštalčný mód** (ochrana batérie, pozri aj str.51+114)
- **Inteligentné nabíjanie batérie** ("intermittent" nabíjanie, pozri aj str.51+114)
- **DIP prepínač** umožňujúci prednastavenie funkcií:
 - **ECO Mód** (stmievanie 10%-100%, pozri aj str.51+114)
- adresovateľný CENTRALTEST komunikačný modul (len pre ATXL, ATXP, ATRF verzie)
- signalizácia LED a TEST tlačítko

OPTIONAL ACCESSORIES

PRÍPLATKY

- **Special suspended plexi with layered design for perfect uniform illumination of legend - must be ordered as a separate item (look up also page No.110)**
- Wall or ceiling mounting brackets (look up also page No.110)
- Wire rope suspension set (look up also page No.110)
- Alternative colour surface treatment in RAL (min order quantity 100pcs)
- **špeciálne vrstvené závesné plexi pre rovnomerné osvetlenie piktogramu na jeho celej ploche (plexi musí byť objednané samostatne podľa želaného piktogramu- pozri aj str.110)**
- nástenná, stropná alebo stropná závesná konzola (pozri aj str.110)
- lanková závesná sada (pozri aj str.110)
- povrchová úprava vo farbe podľa špecifikácie odberateľa (min 100ks)

CEILING MOUNTING WITH SUSPENDED LEGEND
LEDLUX2-P

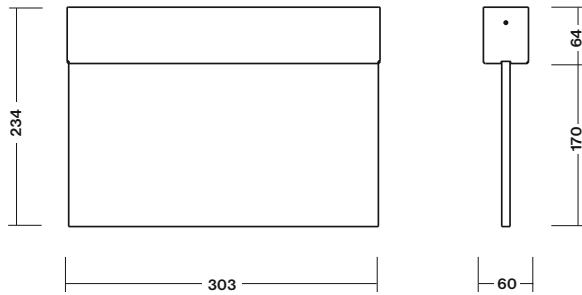

Light source	LED 5000K
	>500cd/m ² (white luminance)
	>200cd/m ² (average luminance)
Installed load	5.3W/5.6VA (maintained M)
	2.0W/3.8VA (non-maintained NM)
	3.0W/5.1VA (CBS)
Suspended plexi	Layered design with high uniformity
Viewing distance	30m

Page No.32

AUTOTEST -AT NM/M

Type	Version	Colour	Light Source	Duration	Battery	Order Code	Weight
MULTILED2-P-AT.3h RAL9006	Only Body, No Plexi incl.	Grey / šedá	MidPower LEDs	3h	LiFePo4 6,4V/1Ah	309-B-002-04-00-01	1,3 kg
MULTILED2-P-AT.3h RAL9003	Only Body, No Plexi incl.	White / biela	MidPower LEDs	3h	LiFePo4 6,4V/1Ah	309-B-002-04-00-02	1,3 kg
MULTILED2-P-AT.3h RAL9005	Only Body, No Plexi incl.	Black / čierna	MidPower LEDs	3h	LiFePo4 6,4V/1Ah	309-B-002-04-00-03	1,3 kg

DALI Self-Contained

Type	Version	Colour	Light Source	Duration	Battery	Order Code	Weight
MULTILED2-P-DALI.3h RAL9006	Only Body, No Plexi incl.	Grey / šedá	MidPower LEDs	3h	LiFePo4 6,4V/1Ah	309-B-015-04-00-01	1,2 kg
MULTILED2-P-DALI.3h RAL9003	Only Body, No Plexi incl.	White / biela	MidPower LEDs	3h	LiFePo4 6,4V/1Ah	309-B-015-04-00-02	1,2 kg
MULTILED2-P-DALI.3h RAL9005	Only Body, No Plexi incl.	Black / čierna	MidPower LEDs	3h	LiFePo4 6,4V/1Ah	309-B-015-04-00-03	1,2 kg

Page No.36

CENTRALTEST -ATXL ELMAX-LOOK

Type	Version	Colour	Light Source	Duration	Battery	Order Code	Weight
MULTILED2-P-ATXL.3h RAL9006	Only Body, No Plexi incl.	Grey / šedá	MidPower LEDs	3h	LiFePo4 6,4V/1Ah	309-B-004-04-00-01	1,4 kg
MULTILED2-P-ATXL.3h RAL9003	Only Body, No Plexi incl.	White / biela	MidPower LEDs	3h	LiFePo4 6,4V/1Ah	309-B-004-04-00-02	1,4 kg
MULTILED2-P-ATXL.3h RAL9005	Only Body, No Plexi incl.	Black / čierna	MidPower LEDs	3h	LiFePo4 6,4V/1Ah	309-B-004-04-00-03	1,4 kg

Page No.38

Wireless CENTRALTEST ELMAX-ATRF

Type	Version	Colour	Light Source	Duration	Battery	Order Code	Weight
MULTILED2-P-ATRF.3h RAL9006	Only Body, No Plexi incl.	Grey / šedá	MidPower LEDs	3h	LiFePo4 6,4V/1Ah	309-B-016-04-00-01	1,3 kg
MULTILED2-P-ATRF.3h RAL9003	Only Body, No Plexi incl.	White / biela	MidPower LEDs	3h	LiFePo4 6,4V/1Ah	309-B-016-04-00-02	1,3 kg

Page No.44

CENTRAL BATTERY (CBS)

Type	Version	Colour	CBS Version for	Light Source	Order Code	Weight
C.LEDLUX2-P 230V AC/DC	Only Body, No Plexi incl.	Grey / šedá	CBS NON-ADDRESSABLE	MidPower LEDs	309-B-007-00-00-01	1,0 kg
C.LEDLUX2-P 230V AC/DC	Only Body, No Plexi incl.	White / biela	CBS NON-ADDRESSABLE	MidPower LEDs	309-B-007-00-00-02	1,0 kg
C.LEDLUX2-P 230V AC/DC	Only Body, No Plexi incl.	Black / čierna	CBS NON-ADDRESSABLE	MidPower LEDs	309-B-007-00-00-05	1,0 kg
C.LEDLUX2-P 24V AC/DC	Only Body, No Plexi incl.	Grey / šedá	CBS NON-ADDRESSABLE	MidPower LEDs	309-B-008-00-00-01	1,0 kg
C.LEDLUX2-P 24V AC/DC	Only Body, No Plexi incl.	White / biela	CBS NON-ADDRESSABLE	MidPower LEDs	309-B-008-00-00-02	1,0 kg

DALI CENTRAL BATTERY (CBS)

Type	Version	Colour	CBS Version for	Light Source	Order Code	Weight
C.LEDLUX2-P-DALI 230V AC	Only Body, No Plexi incl.	Grey / šedá	DALI CBS	MidPower LEDs	309-B-017-00-00-01	1,0 kg
C.LEDLUX2-P-DALI 230V AC	Only Body, No Plexi incl.	White / biela	DALI CBS	MidPower LEDs	309-B-017-00-00-02	1,0 kg
C.LEDLUX2-P-DALI 230V AC	Only Body, No Plexi incl.	Black / čierna	DALI CBS	MidPower LEDs	309-B-017-00-00-03	1,0 kg

Page No.40

Addressable CENTRAL BATTERY (CBS) -ATXP ELMAX-PATROLUX

Type	Version	Colour	CBS Version for	Light Source	Order Code	Weight
C.LEDLUX2-P-ATXPR 230V AC/DC	Only Body, No Plexi incl.	Grey / šedá	CBS ADDRESSABLE	MidPower LEDs	309-B-009-00-00-01	1,1 kg
C.LEDLUX2-P-ATXPR 230V AC/DC	Only Body, No Plexi incl.	White / biela	CBS ADDRESSABLE	MidPower LEDs	309-B-009-00-00-02	1,1 kg



• It is not included in standard package. It must be ordered as separate item !

- Viewing Distance: 30m
- Complying ISO7010
- Legend luminance >500cd/m² (white)

• nie je súčasťou štandardného balenia svietidla, musí byť objednané ako samostatná položka !

- rozoznateľnosť piktogramu: 30m
- v súlade s ISO7010
- jas piktogramu >500cd/m² (biela)



Suspended Legend Accessory

Optional Item	Order Code
Double sided plexi with legend H/J	309-B-000-00-00-01
Double sided plexi with legend I	309-B-000-00-00-02
Single sided plexi with legend H	309-B-000-00-00-03
Single sided plexi with legend I	309-B-000-00-00-04
Single sided plexi with legend J	309-B-000-00-00-05
Double sided plexi with legend K/M	309-B-000-00-00-06
Double sided plexi with legend L/N	309-B-000-00-00-07
Single sided plexi with legend K	309-B-000-00-00-08
Single sided plexi with legend L	309-B-000-00-00-09
Single sided plexi with legend M	309-B-000-00-00-10
Single sided plexi with legend N	309-B-000-00-00-11
Single sided plexi with legend O	309-B-000-00-00-12
Double sided plexi with legend O	309-B-000-00-00-13
Double sided plexi with legend Z1	309-B-000-00-00-27
Double sided plexi with legend Z2	309-B-000-00-00-28

Závesné plexi s piktogramom

Príplatok	Objednávaci kód
Obojstranné plexi s piktogramom H/J	309-B-000-00-00-01
Obojstranné plexi s piktogramom I	309-B-000-00-00-02
Jednostranné plexi s piktogramom H	309-B-000-00-00-03
Jednostranné plexi s piktogramom I	309-B-000-00-00-04
Jednostranné plexi s piktogramom J	309-B-000-00-00-05
Obojstranné plexi s piktogramom K/M	309-B-000-00-00-06
Obojstranné plexi s piktogramom L/N	309-B-000-00-00-07
Jednostranné plexi s piktogramom K	309-B-000-00-00-08
Jednostranné plexi s piktogramom L	309-B-000-00-00-09
Jednostranné plexi s piktogramom M	309-B-000-00-00-10
Jednostranné plexi s piktogramom N	309-B-000-00-00-11
Jednostranné plexi s piktogramom O	309-B-000-00-00-12
Obojstranné plexi s piktogramom O	309-B-000-00-00-13
Obojstranné plexi s piktogramom Z1	309-B-000-00-00-27
Obojstranné plexi s piktogramom Z2	309-B-000-00-00-28



ACCESSORIES LEDLUX2-P

- Optional Accessories:**
- Wall brackets
 - Wire rope suspension set
- Príplatky:**
- nástenné konzoly
 - lankový záves



Parallel wall mounting bracket
Konzola rovnobežne so stenou



RAL9003



RAL9006



RAL9005

Upright wall mounting bracket
Konzola kolmo na stenu



RAL9003



RAL9006



RAL9005

Optional Item / Príplatky	Order Code
Parallel wall mounting bracket in white RAL9003 colour / nástenná konzola rovnobežne so stenou v bielej RAL9003	309-B-000-01-00-02
Parallel wall mounting bracket in grey RAL9006 colour / nástenná konzola rovnobežne so stenou v šedej RAL9006	309-B-000-01-00-01
Parallel wall mounting bracket in black RAL9005 colour / nástenná konzola rovnobežne so stenou v čiernej RAL9005	309-B-000-01-01-03
Upright wall mounting bracket in white RAL9003 colour / konzola kolmo na stenu v bielej RAL9003	309-B-000-03-00-02
Upright wall mounting bracket in grey RAL9006 colour / konzola kolmo na stenu v šedej RAL9006	309-B-000-03-00-01
Upright wall mounting bracket in black RAL9005 colour / konzola kolmo na stenu v čiernej RAL9005	309-B-000-03-01-03
Wire rope suspension set 1,0m long in white RAL9003 colour / lanková závesná sada 1,0m dlhá v bielej RAL9003 farbe	85-B-05-13-01
Wire rope suspension set 1,0m long in grey RAL9006 colour / lanková závesná sada 1,0m dlhá v šedej RAL9006 farbe	85-B-05-13-00
Wire rope suspension set 1,0m long in black RAL9005 colour / lanková závesná sada 1,0m dlhá v čiernej RAL9005 farbe	85-B-05-13-02
Wire rope suspension set 1,5m long in white RAL9003 colour / lanková závesná sada 1,5m dlhá v bielej RAL9003 farbe	85-B-05-25-F1
Wire rope suspension set 1,5m long in grey RAL9006 colour / lanková závesná sada 1,5m dlhá v šedej RAL9006 farbe	85-B-05-25-00
Wire rope suspension set 2,0m long in white RAL9003 colour / lanková závesná sada 2,0m dlhá v bielej RAL9003 farbe	85-B-05-60-00
Wire rope suspension set 2,0m long in grey RAL9006 colour / lanková závesná sada 2,0m dlhá v šedej RAL9006 farbe	85-B-05-18-00
Wire rope suspension set 3,5m long in white RAL9003 colour / lanková závesná sada 3,5m dlhá v bielej RAL9003 farbe	85-B-05-26-F1
Wire rope suspension set 3,5m long in grey RAL9006 colour / lanková závesná sada 3,5m dlhá v šedej RAL9003 farbe	85-B-05-26-00
Pendant ceiling mounting bracket 1,0m in white RAL9003 colour / trubková závesná sada 1,0m dlhá v bielej RAL9003 farbe	85-B-05-27-F1
Pendant ceiling mounting bracket 1,0m in grey RAL9006 colour / trubková závesná sada 1,0m dlhá v šedej RAL9006 farbe	85-B-05-27-F17





Light source	LED 5000K >500cd/m ² (white luminance) >200cd/m ² (average luminance)
Installed load	5.3W/5.6VA (maintained M) 2.0W/3.8VA (non-maintained NM) 3.0W/5.1VA (CBS)
Suspended plexi	Layered design with high uniformity
Viewing distance	30m

UNITED COLORS OF
OF BENETTON.

ACCESSORIES
LEDLUX2

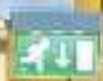

DIP-SWITCH SET-UP FEATURES LEDLUX2-P



DIP SWITCH FEATURES No.1 DIP PREPÍNAČ č.1 - FUNKCIE SELF-CONTAINED BATTERY VERSIONS

NORMAL MODE
230V MAINS

EMERGENCY MODE
BATTERY



ESCAPE SIGN Brightness in 230V
OFF = 100%
BRIGHTNESS > 200cd/m²

ECO MODE 10% (in 230V Mode)
ON = 10%
BRIGHTNESS > 2cd/m²



DIP SWITCH FEATURES No.2-4 DIP PREPÍNAČ č.2-4 - FUNKCIE SELF-CONTAINED BATTERY VERSIONS

INSTALLATION MODE
SET UP

M / NM
NON-MAINTAINED / MAINTAINED MODE SET UP

AT / ATXL
AUTOTEST / CENTRALTEST MODE SET UP

DEFAULT SETTING / PREDNASTAVENÉ
OFF - ACTIVATED
ON - DEACTIVATED

DEFAULT SETTING / PREDNASTAVENÉ
ON - MAINTAINED
OFF - NON-MAINTAINED

DEFAULT SETTING / PREDNASTAVENÉ
OFF - AUTOTEST
ON - CENTRALTEST

TO SEE THE CHANGE PUSH EITHER TEST BUTTON OR DISCONNECT THE FIXTURE FROM BOTH THE MAINS 230V AND BATTERY

Po prestavení stlačte TEST alebo odpojte batériu a 230V napájanie na aktiváciu zmeny

JUMPERS FEATURES JUMPER FUNKCIE CBS CENTRAL BATTERY VERSIONS

There is L1' logical input which allows to control the dimming function of the fixture by presence of 230V on L1'. During the first installation you can preset DIM level either 50% or 40% or 30% or 20% or 10%. The advantage of dimming feature is either energy saving or brightness reduction in e.g.cinema or theatre application.

Svietidlo je vybavené logickým vstupom L1', ktorým je ovládané stmievanie svietidla. Počas prvej inštalácie je možné nastaviť úroveň stmievania na 50% alebo 40% alebo 30% alebo 20% alebo 10%. Táto funkcia prispieva k zníženiu spotreby elektrickej energie alebo môže byť s výhodou použitá v kinách / divadlách, kde je počas predstavenia nežiadúci vysoký jas piktoqramu.

	If 230V presents on L1: Ak je 230V prítomných na L1 :	FULL POWER LEGEND BRIGHTNESS > 200cd/m² JAS PIKTOGRAMU > 200cd/m²
	J9 CLOSE <input type="checkbox"/> J10,11,12 OPEN <input type="checkbox"/>	ECO MODE 50%
	J10 CLOSE <input type="checkbox"/> J9,11,12 OPEN <input type="checkbox"/>	ECO MODE 40%
	J11 CLOSE <input type="checkbox"/> J9,10,12 OPEN <input type="checkbox"/>	ECO MODE 30%
	J12 CLOSE <input type="checkbox"/> J9,10,11 OPEN <input type="checkbox"/>	ECO MODE 20%
	J9,10,11,12 OPEN <input type="checkbox"/>	ECO MODE 10% LEGEND BRIGHTNESS > 2cd/m² JAS PIKTOGRAMU > 2cd/m²

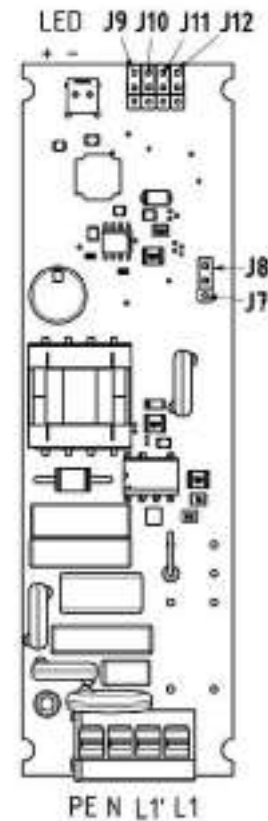

Logic of Dimming:

JUMPER	MAINS INPUT		Lighting Output
J8 - CLOSE (DEFAULT SETTING)	L1	L1'	
	0	0	OFF
	0	1	OFF
	1	0	100%
	1	1	DIMM

JUMPER	MAINS INPUT		Lighting Output
J1 - CLOSE	L1	L2 (L1')	
	0	0	OFF
	0	1	OFF
	1	0	DIMM
	1	1	100%

DIMM - see Dimming option

Dimming options:

JUMPERS				DIMMING LEVEL
J9	J10	J11	J12	
OPEN	OPEN	OPEN	OPEN	10%
OPEN	OPEN	OPEN	CLOSE	20%
OPEN	OPEN	CLOSE	OPEN	30%
OPEN	CLOSE	OPEN	OPEN	40%
CLOSE	OPEN	OPEN	OPEN	50%



RECESSED MOUNTING WITH SUSPENDED LEGEND LEDLUX2-V



Input Power:

- 5,3W/ 5,6VA (maintained M)
- 2,0W/ 3,8VA (non-maintained NM)
- 3,0W/ 5,1VA (CBS)

• **NEW Generation** modern design **recessed LED** non-maintained (NM), maintained (M) or centralised (C) emergency lighting with smooth legend illumination for all **areas such as offices, shops, hotels, banks, entrance halls, schools, hospitals, etc.**

It is available in all following versions:

- **AUTOTEST** (-AT)
- **DALI**
- **CENTRALTEST** (-ATXL) for **ELMAX LOOK** system (look up also page No.36)
- **Wireless CENTRALTEST** (-ATRF) for **ELMAX Wireless** system (page No.38)
- **CENTRAL BATTERY** (C.LEDLUX) for **non-addressable CBS** (look up also page No.44)
- **CENTRAL BATTERY** (-ATXP) for system **ELMAX-PATROLUX & Addressable CBS** (look up also page No.40)
- Conforming to the requirement of EN60598-2-22, EN1838, EN62034
- Legend luminance $>500\text{cd/m}^2$ (white)
- Design: metal sheet body with PE powder coat finish RAL9006 (grey) or RAL9003 (white)
- NOVÁ generácia moderného stropného zapusteného LED svietidla pre **netrvalé (NM), trvalé (M) alebo centrálne (C) núdzové osvetlenie** s perfektnou rovnomernosťou osvetlenia piktogramu **navrhnuté pre všeobecné použitie priestorov ako napr. kancelárie, obchody, školy, nemocnice, vstupné haly, banky a pod.,** aj s funkciami:
- **AUTOTEST** (-AT),
- **DALI**
- **CENTRALTEST** (-ATXL) pre systém **ELMAX LOOK** (pozri str.36)
- **bezdrôtový CENTRALTEST** (-ATRF) pre **ELMAX Wireless** systém (str.38)
- **CENTRAL BATTERY** (C.LEDLUX) pre **neadresovateľné CBS** (pozri str.44)
- **CENTRAL BATTERY** (-ATXP) pre systém **ELMAX-PATROLUX s adresovateľnou CBS** (pozri str. 40)
- spĺňa požiadavky európskej normy EN 60598-2-22, EN1838, EN62034
- jas piktogramu $>500\text{cd/m}^2$ (white)
- konštrukcia: teleso z ocelového plechu vo farbe RAL9006 (šedá) alebo RAL9003 (biela)

STANDARD

ŠTANDARDNÁ VÝBAVA

- **High efficient MidPower (150lm/W, 5000K) LONGLIFE LEDs (>100.000h)**
- **NEW Advanced Electronics**
- **LONGLIFE LiFePo4 battery**
- **Installation Mode** (battery protection, for more details look up page No.51+114)
- **Intelligent battery charging** (intermittent charging, look up page No.51+114)
- **DIP Switch** allowing to preset following functions:
 - **ECO Mode** (dimming 10%-100%, for more details look up page No.51+114)
- Addressable CENTRALTEST communication module (for ATXL, ATXP, ATRF only)
- LEDs indicating presence of power supply and signaling failures + TEST button
- **vysoko účinné MidPower LED (150lm/W, 5000K) so životnosťou min.100000h**
- **progressívna elektronická jednotka**
- **LONGLIFE LiFePo4 batéria**
- **Inštalčný mód** (ochrana batérie, pozri aj str.51+114)
- **Inteligentné nabíjanie batérie** ("intermittent" nabíjanie, pozri aj str.51+114)
- **DIP prepínač** umožňujúci prednastavenie funkcií:
 - **ECO Mód** (stmievanie 10%-100%, pozri aj str.51+114)
- adresovateľný CENTRALTEST komunikačný modul (len pre ATXL, ATXP, ATRF verzie)
- signalizácia LED a TEST tlačítko

ACCESSORIES

PRÍPLATKY

- **Special suspended plexi with layered design for perfect uniform illumination of legend** (it must be ordered as a separate item- further details look up page No.118)
- Alternative colour surface treatment in RAL (min order quantity 100pcs)
- **špeciálne vrstvené závesné plexi pre rovnomerné osvetlenie piktogramu na jeho celej ploche** (plexi musí byť objednané samostatne podľa želaného piktogramu- viď str.118 pre detaily)
- povrchová úprava vo farbe podľa špecifikácie odberateľa (min 100ks)



RECESSED WITH SUSPENDED LEGEND LEDLUX2-V

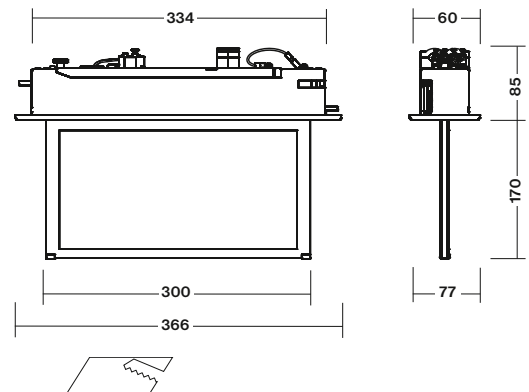

Recessed mounting hole size: 340 x 65 mm
Rozmer montážneho otvoru : 340 x 65 mm

Page No.32

AUTOTEST -AT NM/M

Type	Version	Colour	Light Source	Duration	Battery	Order Code	Weight
MULTILED2-V-AT.3h RAL9006	Only Body, No Plexi incl.	Grey / šedá	MidPower LEDs	3h	LiFePo4 6,4V/1,0Ah	309-B-102-04-00-01	1,3 kg
MULTILED2-V-AT.3h RAL9003	Only Body, No Plexi incl.	White / biela	MidPower LEDs	3h	LiFePo4 6,4V/1,0Ah	309-B-102-04-00-02	1,3 kg
MULTILED2-V-AT.3h RAL9005	Only Body, No Plexi incl.	Black / čierna	MidPower LEDs	3h	LiFePo4 6,4V/1,0Ah	309-B-102-04-00-03	1,3 kg

DALI Self-Contained

Type	Version	Colour	Light Source	Duration	Battery	Order Code	Weight
MULTILED2-V-DALI.3h RAL9006	Only Body, No Plexi incl.	Grey / šedá	MidPower LEDs	3h	LiFePo4 6,4V/1,0Ah	309-B-115-04-00-01	1,2 kg
MULTILED2-V-DALI.3h RAL9003	Only Body, No Plexi incl.	White / biela	MidPower LEDs	3h	LiFePo4 6,4V/1,0Ah	309-B-115-04-00-02	1,2 kg
MULTILED2-V-DALI.3h RAL9005	Only Body, No Plexi incl.	Black / čierna	MidPower LEDs	3h	LiFePo4 6,4V/1,0Ah	309-B-115-04-00-03	1,2 kg

Page No.36

CENTRALTEST -ATXL ELMAX-LOOK

Type	Version	Colour	Light Source	Duration	Battery	Order Code	Weight
MULTILED2-V-ATXL.3h RAL9006	Only Body, No Plexi incl.	Grey / šedá	MidPower LEDs	3h	LiFePo4 6,4V/1,0Ah	309-B-104-04-00-01	1,4 kg
MULTILED2-V-ATXL.3h RAL9003	Only Body, No Plexi incl.	White / biela	MidPower LEDs	3h	LiFePo4 6,4V/1,0Ah	309-B-104-04-00-02	1,4 kg
MULTILED2-V-ATXL.3h RAL9005	Only Body, No Plexi incl.	Black / čierna	MidPower LEDs	3h	LiFePo4 6,4V/1,0Ah	309-B-104-04-00-03	1,4 kg

Page No.38

Wireless CENTRALTEST ELMAX-ATRF

Type	Version	Colour	Light Source	Duration	Battery	Order Code	Weight
MULTILED2-V-ATRF.3h RAL9006	Only Body, No Plexi incl.	Grey / šedá	MidPower LEDs	3h	LiFePo4 6,4V/1,0Ah	309-B-116-04-00-01	1,3 kg
MULTILED2-V-ATRF.3h RAL9003	Only Body, No Plexi incl.	White / biela	MidPower LEDs	3h	LiFePo4 6,4V/1,0Ah	309-B-116-04-00-02	1,3 kg

Page No.44

CENTRAL BATTERY (CBS)

Type	Version	Colour	CBS Version for	Light Source	Order Code	Weight
C.LEDLUX2-V 230V AC/DC	Only Body, No Plexi incl.	Grey / šedá	CBS NON-ADDRESSABLE	MidPower LEDs	309-B-107-00-00-01	1,0 kg
C.LEDLUX2-V 230V AC/DC	Only Body, No Plexi incl.	White / biela	CBS NON-ADDRESSABLE	MidPower LEDs	309-B-107-00-00-02	1,0 kg
C.LEDLUX2-V 230V AC/DC	Only Body, No Plexi incl.	Black / čierna	CBS NON-ADDRESSABLE	MidPower LEDs	309-B-107-00-00-03	1,0 kg
C.LEDLUX2-V 24V AC/DC	Only Body, No Plexi incl.	Grey / šedá	CBS NON-ADDRESSABLE	MidPower LEDs	309-B-108-00-00-01	1,0 kg
C.LEDLUX2-V 24V AC/DC	Only Body, No Plexi incl.	White / biela	CBS NON-ADDRESSABLE	MidPower LEDs	309-B-108-00-00-02	1,0 kg

DALI CENTRAL BATTERY (CBS)

Type	Version	Colour	CBS Version for	Light Source	Order Code	Weight
C.LEDLUX2-V-DALI 230V AC	Only Body, No Plexi incl.	Grey / šedá	DALI CBS	MidPower LEDs	309-B-117-00-00-01	1,0 kg
C.LEDLUX2-V-DALI 230V AC	Only Body, No Plexi incl.	White / biela	DALI CBS	MidPower LEDs	309-B-117-00-00-02	1,0 kg
C.LEDLUX2-V-DALI 230V AC	Only Body, No Plexi incl.	Black / čierna	DALI CBS	MidPower LEDs	309-B-117-00-00-03	1,0 kg

Page No.40

Addressable CENTRAL BATTERY (CBS) -ATXP ELMAX-PATROLUX

Type	Version	Colour	CBS Version for	Light Source	Order Code	Weight
C.LEDLUX2-V-ATXPR 230V AC/DC	Only Body, No Plexi incl.	Grey / šedá	CBS ADDRESSABLE	MidPower LEDs	309-B-109-00-00-01	1,1 kg
C.LEDLUX2-V-ATXPR 230V AC/DC	Only Body, No Plexi incl.	White / biela	CBS ADDRESSABLE	MidPower LEDs	309-B-109-00-00-02	1,1 kg



• It is not included in standard package.
It must be ordered as separate item !

- Viewing Distance: 30m
- Complying ISO7010
- Legend luminance $>500\text{cd/m}^2$ (white)

• Nie je súčasťou štandardného balenia svetidla.
Musí byť objednané ako samostatná položka !

- rozoznatelnosť piktogramu: 30m
- v súlade s ISO7010
- jas piktogramu $>500\text{cd/m}^2$ (biela)



Suspended plexi Accessory

Optional Item / Príplatok	Order Code / Objednávaci kód
Double sided plexi with legend H/J	309-B-000-00-00-01
Double sided plexi with legend I	309-B-000-00-00-02
Single sided plexi with legend H	309-B-000-00-00-03
Single sided plexi with legend I	309-B-000-00-00-04
Single sided plexi with legend J	309-B-000-00-00-05
Double sided plexi with legend K/M	309-B-000-00-00-06
Double sided plexi with legend L/N	309-B-000-00-00-07
Single sided plexi with legend K	309-B-000-00-00-08
Single sided plexi with legend L	309-B-000-00-00-09
Single sided plexi with legend M	309-B-000-00-00-10
Single sided plexi with legend N	309-B-000-00-00-11
Single sided plexi with legend O	309-B-000-00-00-12
Double sided plexi with legend O	309-B-000-00-00-13
Double sided plexi with legend Z1	309-B-000-00-00-27
Double sided plexi with legend Z2	309-B-000-00-00-28

Závesné plexi s piktogramom

Príplatok	Objednávaci kód
Obojstranné plexi s piktogramom H/J	309-B-000-00-00-01
Obojstranné plexi s piktogramom I	309-B-000-00-00-02
Jednostranné plexi s piktogramom H	309-B-000-00-00-03
Jednostranné plexi s piktogramom I	309-B-000-00-00-04
Jednostranné plexi s piktogramom J	309-B-000-00-00-05
Obojstranné plexi s piktogramom K/M	309-B-000-00-00-06
Obojstranné plexi s piktogramom L/N	309-B-000-00-00-07
Jednostranné plexi s piktogramom K	309-B-000-00-00-08
Jednostranné plexi s piktogramom L	309-B-000-00-00-09
Jednostranné plexi s piktogramom M	309-B-000-00-00-10
Jednostranné plexi s piktogramom N	309-B-000-00-00-11
Jednostranné plexi s piktogramom O	309-B-000-00-00-12
Obojstranné plexi s piktogramom O	309-B-000-00-00-13
Obojstranné plexi s piktogramom Z1	309-B-000-00-00-27
Obojstranné plexi s piktogramom Z2	309-B-000-00-00-28



Hotel restaurant area emergency lighting application



WALL & CEILING MOUNTING WITH SUSPENDED LEGEND LEDLUX2-R



- Modern design orientated **surface mounted LED** non-maintained/maintained (NM/M) or centralised (C) emergency lighting with smooth legend illumination for all **areas such as offices, shops, hotels, banks, entrance halls, schools, hospitals, etc.**
- It is equipped with the joint allowing to install the fixture either on the wall or ceiling without any additional bracket
It is available in all following versions:
 - **AUTOTEST** (-AT)
 - **DALI**
 - **CENTRALTEST** (-ATXL) for **ELMAX LOOK** system (look up also page No.36)
 - **Wireless CENTRALTEST** (-ATRF) for **ELMAX Wireless** system (page No.38)
 - **CENTRAL BATTERY** (C.LEDLUX-R) for **non-addressable CBS** (look up also page No.44)
 - **CENTRAL BATTERY** (-ATXP) for system **ELMAX-PATROLUX & Addressable CBS** (look up also page No.40)
- Legend luminance $>500\text{cd/m}^2$ (white)
- Conforming to the requirement of EN60598-2-22, EN1838, EN62034
- Design: AL extruded profile body & die-casted end caps, all with PE powder coat finish RAL9006 (grey), RAL9003 (white) or RAL9005 (black)

- Elegantly LED svietidlá pre **netrvalé/trvalé (NM/M)** alebo **centrálne (C)** núdzové osvetlenie s perfektnou rovnomernosťou osvetlenia piktogramu navrhnuté pre **všeobecné použitie priestorov** ako napr. kancelárie, obchody, školy, nemocnice, vstupné haly, banky a pod.,
- Svetidlo je vybavené otočným kĺbom, ktorý dovoľuje inštaláciu na strop alebo kolmu stenu bez potreby dodatočnej konzoly
- Verzie s funkciami:
 - **AUTOTEST** (-AT)
 - **DALI**
 - **CENTRALTEST** (-ATXL) pre systém ELMAX LOOK (pozri str.36)
 - **bezdrôtový CENTRALTEST** (-ATRF) pre ELMAX Wireless systém (pozri str.38)
 - **CENTRAL BATTERY** (C.LEDLUX-R) pre **neadresovateľné CBS** (pozri str.44)
 - **CENTRAL BATTERY** (-ATXP) pre systém **ELMAX-PATROLUX s adresovateľnou CBS** (pozri str. 40)
- spĺňa požiadavky európskej normy EN 60598-2-22, EN1838, EN62034
- Jas piktogramu $>500\text{cd/m}^2$ (white)
- konštrukcia: teleso z extrudovaného AL profilu, čelá AL odliatky - vo farbe RAL9006 (šedá), RAL9003 (biela) alebo RAL9005 (čierna)

STANDARD FEATURES

STANDARDNÁ VÝBAVA

- **High efficient MidPower (150lm/W, 5000K) LONGLIFE LEDs (>100.000h)**
- **NEW Advanced Electronics**
- **LONGLIFE LiFePo4 battery**
- **Installation Mode** (battery protection, for more details look up page No.51+122)
- **Intelligent battery charging** (intermittent charging, look up page No.51+122)
- **DIP Switch** allowing to preset following functions:
 - **ECO Mode** (dimming 10%-100%, for more details look up page No.51+122)
- Addressable CENTRALTEST communication module (for ATXL, ATXP, ATRF only)
- LEDs indicating presence of power supply and signaling failures & TEST button
- **vysoko účinné MidPower LED (150lm/W, 5000K) so životnosťou min.100000h**
- **progresívna elektronická jednotka**
- **LONGLIFE LiFePo4 batéria**
- **Inštaláčny mód** (ochrana batérie, pozri aj str.51+122)
- **Inteligentné nabíjanie batérie** ("intermittent" nabíjanie, pozri aj str.51+122)
- **DIP prepínač** umožňujúci prednastavenie funkcií:
 - **ECO Mód** (stmievanie 10%-100%, pozri aj str.51+122)
- adresovateľný CENTRALTEST komunikačný modul (len pre ATXL, ATXP, ATRF verzie)
- signalizácia LED a TEST tlačítko

OPTIONAL ACCESSORIES

PRÍPLATKY

- **Special suspended plexi with layered design for perfect uniform illumination of legend - must be ordered as a separate item (look up also page No.122)**
- Wire rope suspension set (look up also page No.123)
- Alternative colour surface treatment in RAL (min order quantity 100pcs)
- **špeciálne vrstvené závesné plexi pre rovnomerné osvetlenie piktogramu na jeho celej ploche (plexi musí byť objednané samostatne podľa želaného piktogramu- pozri aj str.122)**
- lanková závesná sada (pozri aj str.123)
- povrchová úprava vo farbe podľa špecifikácie odberateľa (min obj.100ks)

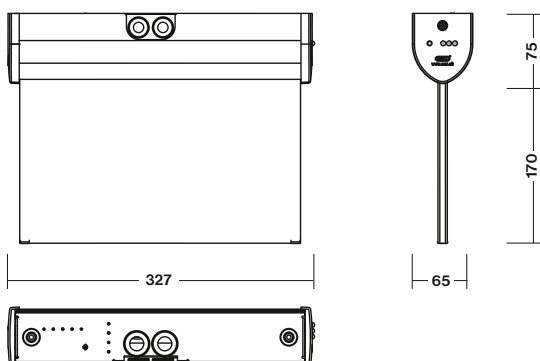

WALL & CEILING MOUNTING WITH SUSPENDED LEGEND LEDLUX2-R



RAL9005
Surface Treatment



RAL9006
Surface Treatment



RAL9003
Surface Treatment

Page No.32

AUTOTEST -AT NM/M

Type	Version	Colour	Light Source	Duration	Battery	Order Code	Weight
MULTILED2-R-AT.3h RAL9006	Only Body, No Plexi incl.	Grey / šedá	MidPower LEDs	3h	LiFePo4 6,4V/1Ah	331-B-001-04-00-01	1,3 kg
MULTILED2-R-AT.3h RAL9003	Only Body, No Plexi incl.	White / biela	MidPower LEDs	3h	LiFePo4 6,4V/1Ah	331-B-001-04-00-02	1,3 kg
MULTILED2-R-AT.3h RAL9005	Only Body, No Plexi incl.	Black / čierna	MidPower LEDs	3h	LiFePo4 6,4V/1Ah	331-B-001-04-00-03	1,3 kg

DALI SELF-CONTAINED

Type	Version	Colour	Light Source	Duration	Battery	Order Code	Weight
MULTILED2-R-DALI.3h RAL9006	Only Body, No Plexi incl.	Grey / šedá	MidPower LEDs	3h	LiFePo4 6,4V/1Ah	331-B-002-04-00-01	1,2 kg
MULTILED2-R-DALI.3h RAL9003	Only Body, No Plexi incl.	White / biela	MidPower LEDs	3h	LiFePo4 6,4V/1Ah	331-B-002-04-00-02	1,2 kg
MULTILED2-R-DALI.3h RAL9005	Only Body, No Plexi incl.	Black / čierna	MidPower LEDs	3h	LiFePo4 6,4V/1Ah	331-B-002-04-00-03	1,2 kg

Page No.36

CENTRALTEST -ATXL ELMAX-LOOK

Type	Version	Colour	Light Source	Duration	Battery	Order Code	Weight
MULTILED2-R-ATXL.3h RAL9006	Only Body, No Plexi incl.	Grey / šedá	MidPower LEDs	3h	LiFePo4 6,4V/1Ah	331-B-003-04-00-01	1,4 kg
MULTILED2-R-ATXL.3h RAL9003	Only Body, No Plexi incl.	White / biela	MidPower LEDs	3h	LiFePo4 6,4V/1Ah	331-B-003-04-00-02	1,4 kg
MULTILED2-R-ATXL.3h RAL9005	Only Body, No Plexi incl.	Black / čierna	9xMidPower LEDs	3h	LiFePo4 6,4V/1Ah	331-B-003-04-00-03	1,4 kg

Page No.38

Wireless CENTRALTEST ELMAX-ATRF

Type	Version	Colour	Light Source	Duration	Battery	Order Code	Weight
MULTILED2-R-ATRF.3h RAL9006	Only Body, No Plexi incl.	Grey / šedá	MidPower LEDs	3h	LiFePo4 6,4V/1Ah	331-B-004-04-00-01	1,3 kg
MULTILED2-R-ATRF.3h RAL9003	Only Body, No Plexi incl.	White / biela	MidPower LEDs	3h	LiFePo4 6,4V/1Ah	331-B-004-04-00-02	1,3 kg

Page No.44

CENTRAL BATTERY (CBS)

Type	Version	Colour	CBS Version for	Light Source	Order Code	Weight
C.LEDLUX2-R 230V AC/DC	Only Body, No Plexi incl.	Grey / šedá	CBS NON-ADDRESSABLE	MidPower LEDs	331-B-005-00-00-01	1,0 kg
C.LEDLUX2-R 230V AC/DC	Only Body, No Plexi incl.	White / biela	CBS NON-ADDRESSABLE	MidPower LEDs	331-B-005-00-00-02	1,0 kg
C.LEDLUX2-R 230V AC/DC	Only Body, No Plexi incl.	Black / čierna	CBS NON-ADDRESSABLE	MidPower LEDs	331-B-005-00-00-03	1,0 kg
C.LEDLUX2-R 24V AC/DC	Only Body, No Plexi incl.	Grey / šedá	CBS NON-ADDRESSABLE	MidPower LEDs	331-B-006-00-00-01	1,0 kg
C.LEDLUX2-R 24V AC/DC	Only Body, No Plexi incl.	White / biela	CBS NON-ADDRESSABLE	MidPower LEDs	331-B-006-00-00-02	1,0 kg

DALI CENTRAL BATTERY (CBS)

Type	Version	Colour	CBS Version for	Light Source	Order Code	Weight
C.LEDLUX2-R-DALI 230V AC	Only Body, No Plexi incl.	Grey / šedá	DALI CBS	MidPower LEDs	331-B-007-00-00-01	1,0 kg
C.LEDLUX2-R-DALI 230V AC	Only Body, No Plexi incl.	White / biela	DALI CBS	MidPower LEDs	331-B-007-00-00-02	1,0 kg
C.LEDLUX2-R-DALI 230V AC	Only Body, No Plexi incl.	Black / čierna	DALI CBS	MidPower LEDs	331-B-007-00-00-03	1,0 kg

Page No.40

Addressable CENTRAL BATTERY (CBS) -ATXP ELMAX-PATROLUX

Type	Version	Colour	CBS Version for	Light Source	Order Code	Weight
C.LEDLUX2-R-ATXPR 230V AC/DC	Only Body, No Plexi incl.	Grey / šedá	CBS ADDRESSABLE	MidPower LEDs	331-B-008-00-00-01	1,1 kg
C.LEDLUX2-R-ATXPR 230V AC/DC	Only Body, No Plexi incl.	White / biela	CBS ADDRESSABLE	MidPower LEDs	331-B-008-00-00-02	1,1 kg

LEDLUX2-R



• It is not included in standard package. It must be ordered as separate item !

- Viewing Distance: 30m
- Complying ISO7010
- Legend luminance >500cd/m² (white)

• nie je súčasťou štandardného balenia svietidla, musí byť objednané ako samostatná položka !

- rozoznatelnosť piktogramu: 30m
- v súlade s ISO7010
- jas piktogramu >500cd/m² (biela)

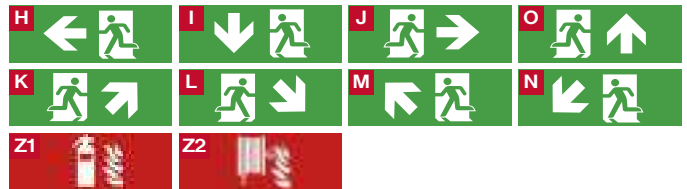

Plexi Legend / plexi s pikto

Optional Item	Order Code
Double sided plexi H/J / obojstranné pikto H/J	309-B-000-00-00-01
Double sided plexi I / obojstranné pikto I	309-B-000-00-00-02
Single sided plexi H / jednostranné pikto H	309-B-000-00-00-03
Single sided plexi I / jednostranné pikto I	309-B-000-00-00-04
Single sided plexi J / jednostranné pikto J	309-B-000-00-00-05
Double sided plexi K/M / obojstranné pikto K/M	309-B-000-00-00-06
Double sided plexi L/N / obojstranné pikto L/N	309-B-000-00-00-07
Single sided plexi K / jednostranné pikto K	309-B-000-00-00-08
Single sided plexi L / jednostranné pikto L	309-B-000-00-00-09
Single sided plexi M / jednostranné pikto M	309-B-000-00-00-10
Single sided plexi N / jednostranné pikto N	309-B-000-00-00-11
Double sided plexi O / obojstranné pikto O	309-B-000-00-00-13
Double sided plexi Z1 / obojstranné pikto Z1	309-B-000-00-00-27
Double sided plexi Z2 / obojstranné pikto Z2	309-B-000-00-00-28



DIP SWITCH FEATURES No.1-4 DIP PREPÍNAČ č.1-4 : FUNKCIE

SELF-CONTAINED BATTERY VERSIONS

NORMAL MODE
230V MAINS

EMERGENCY MODE
BATTERY



ESCAPE SIGN Brightness in 230V
OFF = 100%
BRIGHTNESS > 200cd/m²

ECO MODE 10% (in 230V Mode)
ON = 10%
BRIGHTNESS > 2cd/m²

INSTALLATION MODE
SET UP

DEFAULT SETTING / PREDNASTAVENÉ
OFF - ACTIVATED
ON - DEACTIVATED

M / NM
NON-MAINTAINED / MAINTAINED MODE
SET UP

DEFAULT SETTING / PREDNASTAVENÉ
OFF - NON-MAINTAINED

AT / ATXL
AUTOTEST / CENTRALTEST MODE
SET UP

DEFAULT SETTING / PREDNASTAVENÉ
OFF - AUTOTEST
ON - CENTRALTEST

TO SEE THE CHANGE PUSH EITHER TEST BUTTON OR DISCONNECT THE FIXTURE FROM BOTH THE MAINS 230V AND BATTERY

Po prestavení stlačte TEST alebo odpojte batériu a 230V napájanie na aktiváciu zmeny

JUMPER FEATURES

CBS CENTRAL BATTERY VERSIONS

There is L1' logical input which allows to control the dimming function of the fixture by presence of 230V on L1'. During the first installation you can preset DIM level either 50% or 40% or 30% or 20% or 10%. The advantage of dimming feature is either energy saving or brightness reduction in e.g.cinema or theatre application.

Svietidlo je vybavené logickým vstupom L1', ktorým je ovládané stmievanie svietidla. Počas prvej inštalácie je možné nastaviť úroveň stmievania na 50% alebo 40% alebo 30% alebo 20% alebo 10%. Táto funkcia prispieva k zníženiu spotreby elektrickej energie alebo môže byť s výhodou použitá v kinách / divadlách, kde je počas predstavenia nežiadúci vysoký jas piktogramu.

Logic of Dimming:

JUMPER	MAINS INPUT		Lighting Output
	L1	L1'	
J8 - CLOSE (DEFAULT SETTING)	0	0	OFF
	0	1	OFF
	1	0	100%
	1	1	DIMM

JUMPER	MAINS INPUT		Lighting Output
	L1	L2 (L1')	
J7 - CLOSE	0	0	OFF
	0	1	OFF
	1	0	DIMM
	1	1	100%

DIMM - see Dimming option

Dimming options:

JUMPERS				DIMMING LEVEL
J9	J10	J11	J12	
OPEN	OPEN	OPEN	OPEN	10%
OPEN	OPEN	OPEN	CLOSE	20%
OPEN	OPEN	CLOSE	OPEN	30%
OPEN	CLOSE	OPEN	OPEN	40%
CLOSE	OPEN	OPEN	OPEN	50%

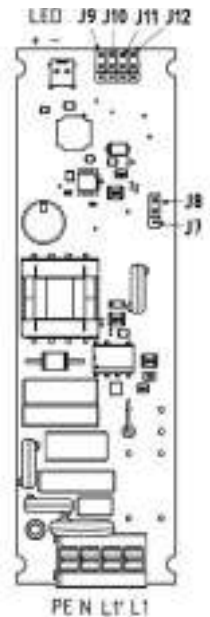

If 230V presents on L1:
Ak je 230V prítomných na L1 :

FULL POWER
LEGEND BRIGHTNESS > 200cd/m²
JAS PIKTOGRAMU > 200cd/m²



ECO MODE 50%



ECO MODE 40%



ECO MODE 30%



ECO MODE 20%



ECO MODE 10%
LEGEND BRIGHTNESS > 2cd/m²
JAS PIKTOGRAMU > 2cd/m²

ACCESSORIES LEDLUX2-R



- Optional Accessories:**
- Wall brackets
 - Wire rope suspension set
- Príplatky:**
- nástenné konzoly
 - lankový záves

Upright wall mounting bracket
Konzola kolmo na stenu



RAL9003



RAL9006



RAL9005

Optional Item / Príplatky	Order Code / objedn.kód
Upright wall mounting bracket in white RAL9003 colour / konzola kolmo na stenu v bielej RAL9003	331-B-000-01-00-02
Upright wall mounting bracket in grey RAL9006 colour / konzola kolmo na stenu v šedej RAL9006	331-B-000-01-00-01
Upright wall mounting bracket in black RAL9005 colour / konzola kolmo na stenu v čiernej RAL9005	331-B-000-01-00-03
Wire rope suspension set 1,0m long in white RAL9003 colour / lanková závesná sada 1,0m dlhá v bielej RAL9003 farbe	85-B-05-13-01
Wire rope suspension set 1,0m long in grey RAL9006 colour / lanková závesná sada 1,0m dlhá v šedej RAL9006 farbe	85-B-05-13-00
Wire rope suspension set 1,0m long in black RAL9005 colour / lanková závesná sada 1,0m dlhá v čiernej RAL9005 farbe	85-B-05-13-02
Wire rope suspension set 1,5m long in white RAL9003 colour / lanková závesná sada 1,5m dlhá v bielej RAL9003 farbe	85-B-05-25-F1
Wire rope suspension set 1,5m long in grey RAL9006 colour / lanková závesná sada 1,5m dlhá v šedej RAL9006 farbe	85-B-05-25-00
Wire rope suspension set 2,0m long in white RAL9003 colour / lanková závesná sada 2,0m dlhá v bielej RAL9003 farbe	85-B-05-60-00
Wire rope suspension set 2,0m long in grey RAL9006 colour / lanková závesná sada 2,0m dlhá v šedej RAL9006 farbe	85-B-05-18-00
Wire rope suspension set 3,5m long in white RAL9003 colour / lanková závesná sada 3,5m dlhá v bielej RAL9003 farbe	85-B-05-26-F1
Wire rope suspension set 3,5m long in grey RAL9006 colour / lanková závesná sada 3,5m dlhá v šedej RAL9003 farbe	85-B-05-26-00
Pendant ceiling mounting bracket 1,0m in white RAL9003 colour / trubková závesná sada 1,0m dlhá v bielej RAL9003 farbe	85-B-05-27-F1
Pendant ceiling mounting bracket 1,0m in grey RAL9006 colour / trubková závesná sada 1,0m dlhá v šedej RAL9006 farbe	85-B-05-27-F17



WALL MOUNTING WITH OPTIONAL SIDE LEDS TRACKLUX



TRACKLUX as only escape route sign



Input Power:

- 5,8W/ 6,1VA (maintained M)
- 2,0W/ 3,9VA (non-maintained NM)
- 6,1W/ 6,3VA (CBS)

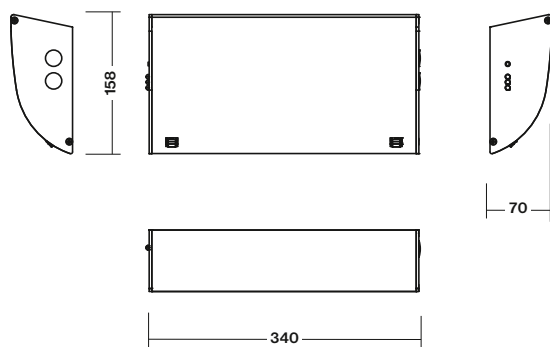

- multifunctional wall mounted powerful LED fixture available also with 2 bottom LEDs for escape route illumination:
 - **version "A"** is direct beam distributing light in front of the fixture, suitable for areas such as all **above door, staircase, elevator waiting zone**, etc
 - **version "B"** is side beam distributing light to both side direction in order to illuminate a **corridor area**
- for all non-maintained/maintained (NM/M) or centralised (C) emergency lighting available in all following versions:
 - **AUTOTEST (-AT)** or **DALI**
 - **CENTRALTEST (-ATXL)** for ELMAX-Look Mini system (look up also page 36)
 - **Wireless CENTRALTEST (-ATRF)** for **ELMAX Wireless** system (page No.38)
 - **CENTRAL BATTERY (C.TRACKLUX)** for **non-addressable CBS** (page 44)
 - **CENTRAL BATTERY (-ATXP)** for system **ELMAX-PATROLUX Mini & Addressable CBS** (look up also page No.40)
- Conforming to the requirement of EN60598-2-22, EN1838, EN62034
- Design:
 - Diffuser made from polycarbonate
 - End caps made AL painted in white RAL9003
 - Base made from extruded AL profile painted in white RAL9003

- elegantné nástenné LED núdzové svietidlo v 3 verziách, z ktorých 2 majú dve výkonné spodné LED pre osvetlenie únikovej cesty a to:
 - verzie "A" - svetelný tok je nasmerovaný priamo pred svietidlo na podlahu, zvlášť vhodné pre osvetlenie prietorov pred dvermi (montáž nad dvere), na schodisku, pri výťahoch a pod.
 - verzie "B" - svetelný tok je nasmerovaný do oboch strán, zvlášť vhodné pre osvetlenie chodieb a koridorov
- pre trvalé/netrvané (NM/M) alebo (C) centrálné napájané núdzové osvetlenie dostupné vo verziách pre:
 - **AUTOTEST (-AT)** alebo **DALI**
 - **bezdrôtový CENTRALTEST (-ATRF)** pre ELMAX Wireless systém (pozri str.38)
 - **CENTRALTEST (-ATXL)** pre systém ELMAX-LOOK Mini (pozri str.36)
 - **CENTRAL BATTERY (C.TRACKLUX2)** pre **neadresovateľné CBS** (str. 44)
 - **CENTRAL BATTERY (-ATXP)** pre systém **ELMAX-PATROLUX Mini s adresovateľnou CBS** (pozri str. 40)
- spĺňa požiadavky európskej normy EN 60598-2-22, EN1838, EN62034
- konštrukcia:
 - kryt svietidla vyrobený z nerozbitného polykarbonátu
 - bočnice AL lakované RAL9003
 - základňa svietidla - extrudovaný AL profil lakovaný RAL9003

STANDARD FEATURES

STANDARDNÁ VÝBAVA

- **High efficient (150lm/W, 5000K) LONGLIFE LEDs (>100.000h)**
- **2pcs of High-Power bottom LEDs 120lm/W** for floor escape route illumination (valid only for all "+2xLED" versions)
- **NEW Advanced Electronics**
- **LONGLIFE LiFePo4 battery**
- **Installation Mode** (battery protection, for more details look up page No.51+126)
- **Intelligent battery charging** (intermittent charging, look up page No.51+126)
- **DIP Switch** allowing to preset following functions:
 - **ECO Mode** (dimming 10%-100%, for more details look up page No.51+126)
 - **ENERGY Saving Mode** (picto illumination 2cd/m² or 200cd/m², look up page 51)
 - **2 bottom LEDs control** (ON/OFF during operation on mains 230V, page No.126)
- Addressable CENTRALTEST communication module (for ATXL, ATXP only)
- LEDs indicating presence of power supply and signaling failures + TEST button
- Self-adhesive legends
- **vysoko účinné LED (150lm/W, 5000K) so životnosťou min.100000h**
- **2 výkonné LED 120lm/W pre osvetlenie únikovej cesty na podlahe** (len pri "+2xLED" verziách)
- **progressívna elektronická jednotka**
- **LONGLIFE LiFePo4 batéria**
- **Inštaláčny mód** (ochrana batérie, pozri aj str.51+126)
- **Inteligentné nabíjanie batérie** ("intermittent" nabíjanie, pozri aj str.51+126)
- **DIP prepínač** umožňujúci prednastavenie funkcií:
 - **ECO Mód** (stmievanie 10%-100%, pozri aj str.51+126)
 - **ENERGY Saving Mód** (osvetlenie pikto na 2cd/m² alebo 200cd/m², pozri aj str.126)
- ovládanie **2 spodných LED** (zap/vyp počas normálneho režimu 230V, pozri aj str.126)
- adresovateľný CENTRALTEST komunikačný modul (len pre ATXL, ATXP verzie)
- signalizácia LED a TEST tlačítko
- samolepiace piktogramy



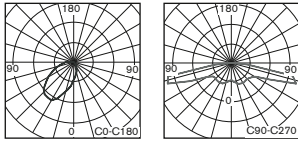

Valid for all **+2xLED-A versions**
 Pre všetky verzie **+2xLED-A**

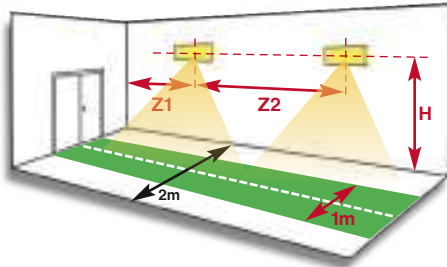

For corridor areas up to 2m in width the escape route should be 1m wide. In the central line min 1lux and in the whole escape route area min 0,5lux levels are required (EN1838).

1LX SPACING TABLE / ROZMIESTNENIE PRE 1LX

H (m)	Z1 (m)	Z2 (m)
2,30	8	17



TRACKLUX-A+2xLED

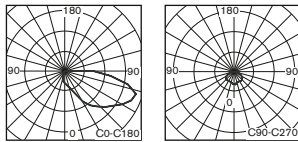

Valid for all **+2xLED-B versions**
 Pre všetky verzie **+2xLED-B**

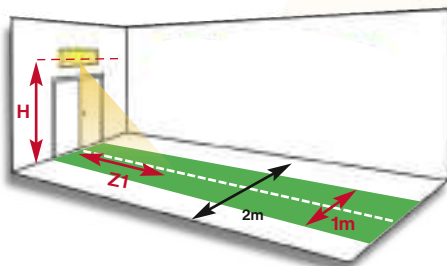

For corridor areas up to 2m in width the escape route should be 1m wide. In the central line min 1lux and in the whole escape route area min 0,5lux levels are required (EN1838).

1LX SPACING TABLE / ROZMIESTNENIE PRE 1LX

H (m)	Z1 (m)
2,30	6



TRACKLUX-B+2xLED

DIP-SWITCH SET-UP FEATURES TRACKLUX



**ENERGY SAVING
ECO MODE
SET UP**



**2/200
cd/m²**

**NO
AT**

DIP SWITCH FEATURES No.1-4 / DIP PREPÍNAČ č.1-4 - FUNKCIE

SELF-CONTAINED BATTERY VERSIONS

**NORMAL MODE
230V MAINS**

**EMERGENCY
BATTERY MODE**



DEFFAULT SETT./ PREDNASTAVENÉ
Full Power for ESCAPE SIGN Applicator
BRIGHTNESS > 200cd/m²

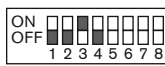

ECO MODE 50% (in 230V mode)
EMERGENCY MODE LEGEND
BRIGHTNESS > 200cd/m²

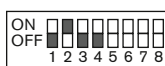

ECO MODE 25% (in 230V mode)
EMERGENCY MODE LEGEND
BRIGHTNESS > 200cd/m²



ECO MODE 10% (in 230V mode)
EMERGENCY MODE LEGEND
BRIGHTNESS > 200cd/m²



ENERGY SAVING (in emerg.mode)
LEGEND BRIGHTNESS > 2cd/m²
JAS PIKTOGRAMU > 2cd/m²



ENERGY SAVING (in emerg.mode)
ECO MODE 50% (in 230V mode)
LEGEND BRIGHTNESS > 2cd/m²

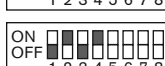

ENERGY SAVING (in emerg.mode)
ECO MODE 25% (in 230V mode)
LEGEND BRIGHTNESS > 2cd/m²

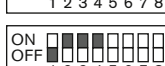

ENERGY SAVING (in emerg.mode)
ECO MODE 10% (in 230V mode)
LEGEND BRIGHTNESS > 2cd/m²

**INSTALLATION
MODE
SET UP**

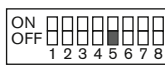

DEFFAULT / PREDNASTAVENÉ
OFF - ACTIVATED
ON - DEACTIVATED

**M /
NM** **NON-MAINTAINED /
MAINTAINED
MODE
SET UP**

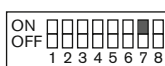

DEFFAULT / PREDNASTAVENÉ
ON - MAINTAINED
OFF - NON-MAINTAINED

**NO
AT** **NO-AUTOTEST
MODE
SET UP**

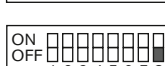

DEFFAULT / PREDNASTAVENÉ
OFF - AUTOTEST ACTIVE
ON - NO-AUTOTEST

CBS CENTRAL BATTERY VERSIONS

**CBS CENTRAL
BATTERY**

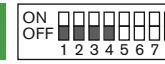

FULL POWER
LEGEND BRIGHTNESS > 200cd/m²
JAS PIKTOGRAMU > 200cd/m²

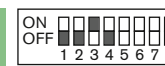

ECO MODE 50%



ECO MODE 25%



ECO MODE 10%
LEGEND BRIGHTNESS > 2cd/m²
JAS PIKTOGRAMU > 2cd/m²

**L1'
Logic**

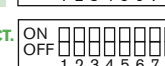

ONLY FOR CBS VERSIONS
ON - NEGATIVE
OFF - POSITIVE

**TO SEE THE CHANGE EITHER PUSH THE TEST BUTTON OR
DISCONNECT THE FIXTURE FROM BOTH THE MAINS 230V AND BATTERY**

Po prestavení stlačte TEST alebo odpojte batériu a pripojenie na sieť na aktiváciu zmeny

DIP SWITCH FEATURES No.1-4 / DIP PREPÍNAČ č.1-4 - FUNKCIE

SELF-CONTAINED BATTERY VERSIONS (not valid for DALI versions)

**NORMAL MODE
230V MAINS**

**EMERGENCY
BATTERY MODE**

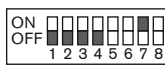
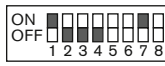

**+2xLED
BOTTOM LEDs
ACTIVATION**

NO LEGEND / BEZ PIKTOGRAMU
ESCAPE ROUTE ILLUMINATION

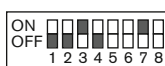

DEFFAULT SETT./ PREDNASTAVENÉ
Full Power for ESCAPE SIGN Applicator
BRIGHTNESS > 200cd/m²



ECO MODE 50% (in 230V mode)
EMERGENCY MODE LEGEND
BRIGHTNESS > 200cd/m²



ECO MODE 25% (in 230V mode)
EMERGENCY MODE LEGEND
BRIGHTNESS > 200cd/m²



ECO MODE 10% (in 230V mode)
EMERGENCY MODE LEGEND
BRIGHTNESS > 200cd/m²

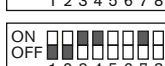

ENERGY SAVING (in emerg.mode)
LEGEND BRIGHTNESS > 2cd/m²
JAS PIKTOGRAMU > 2cd/m²



ENERGY SAVING (in emerg.mode)
ECO MODE 50% (in 230V mode)
LEGEND BRIGHTNESS > 2cd/m²

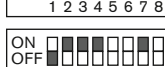

ENERGY SAVING (in emerg.mode)
ECO MODE 25% (in 230V mode)
LEGEND BRIGHTNESS > 2cd/m²

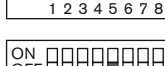

ENERGY SAVING (in emerg.mode)
ECO MODE 10% (in 230V mode)
LEGEND BRIGHTNESS > 2cd/m²

**INSTALLATION
MODE
SET UP**



DEFFAULT / PREDNASTAVENÉ
OFF - ACTIVATED
ON - DEACTIVATED

**M /
NM** **NON-MAINTAINED /
MAINTAINED
MODE
SET UP**

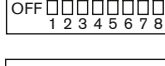

DEFFAULT / PREDNASTAVENÉ
ON - MAINTAINED
OFF - NON-MAINTAINED

**NO
AT** **NO-AUTOTEST
MODE
SET UP**

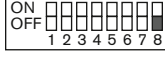

DEFFAULT / PREDNASTAVENÉ
OFF - AUTOTEST ACTIVE
ON - NO-AUTOTEST

CBS CENTRAL BATTERY VERSIONS (not valid for DALI versions)

**CBS CENTRAL
BATTERY**

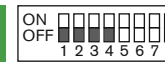

FULL POWER
LEGEND BRIGHTNESS > 200cd/m²
JAS PIKTOGRAMU > 200cd/m²

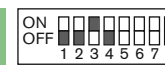

ECO MODE 50%



ECO MODE 25%



ECO MODE 10%
LEGEND BRIGHTNESS > 2cd/m²
JAS PIKTOGRAMU > 2cd/m²

**L1'
Input**



ONLY FOR CBS VERSIONS
ON - +2 BOTTOM LEDs CONTROL
OFF - DIMMING

**L1'
Logic**

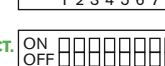

ONLY FOR CBS VERSIONS
ON - NEGATIVE
OFF - POSITIVE

**TO SEE THE CHANGE EITHER PUSH THE TEST BUTTON OR
DISCONNECT THE FIXTURE FROM BOTH THE MAINS 230V AND BATTERY**

Po prestavení stlačte TEST alebo odpojte batériu a pripojenie na sieť na aktiváciu zmeny

Page No.32

AUTOTEST -AT NM/M

Type	Version	Light Source	Duration	Battery	Order Code	Weight
TRACKLUX-AT.1h	NM/M	SAMSUNG MidPower LEDs 5000K	1h	LiFePo4 6,4V/1,0Ah	334-B-001-04-00-00	1,2 kg
TRACKLUX-AT.3h	NM/M	SAMSUNG MidPower LEDs 5000K	3h	LiFePo4 6,4V/2,0Ah	334-B-002-04-00-00	1,3 kg
TRACKLUX-A-AT+2xLED.1h	NM/M	MidPower LEDs 5000K + 2xHighPower	1h	LiFePo4 6,4V/1,0Ah	334-B-003-04-00-00	1,3 kg
TRACKLUX-A-AT+2xLED.3h	NM/M	MidPower LEDs 5000K + 2xHighPower	3h	LiFePo4 6,4V/2,0Ah	334-B-004-04-00-00	1,4 kg
TRACKLUX-B-AT+2xLED.1h	NM/M	MidPower LEDs 5000K + 2xHighPower	1h	LiFePo4 6,4V/1,0Ah	334-B-005-04-00-00	1,3 kg
TRACKLUX-B-AT+2xLED.3h	NM/M	MidPower LEDs 5000K + 2xHighPower	3h	LiFePo4 6,4V/2,0Ah	334-B-006-04-00-00	1,4 kg

DALI SELF-CONTAINED

Type	Version	Light Source	Duration	Battery	Order Code	Weight
TRACKLUX-DALI.1h	NM/M	SAMSUNG MidPower LEDs 5000K	1h	LiFePo4 6,4V/1,0Ah	334-B-007-04-00-00	1,2 kg
TRACKLUX-DALI.3h	NM/M	SAMSUNG MidPower LEDs 5000K	3h	LiFePo4 6,4V/2,0Ah	334-B-008-04-00-00	1,4 kg

Page No.36

CENTRALTEST ELMAX-LOOK

Type	Version	Light Source	Duration	Battery	Order Code	Weight
TRACKLUX-ATXL.1h	NM/M	SAMSUNG MidPower LEDs 5000K	1h	LiFePo4 6,4V/1,0Ah	334-B-013-04-00-00	1,2 kg
TRACKLUX-ATXL.3h	NM/M	SAMSUNG MidPower LEDs 5000K	3h	LiFePo4 6,4V/2,0Ah	334-B-014-04-00-00	1,3 kg
TRACKLUX-A-ATXL+2xLED.1h	NM/M	MidPower LEDs 5000K + 2xHighPower	1h	LiFePo4 6,4V/1,0Ah	334-B-015-04-00-00	1,3 kg
TRACKLUX-A-ATXL+2xLED.3h	NM/M	MidPower LEDs 5000K + 2xHighPower	3h	LiFePo4 6,4V/2,0Ah	334-B-016-04-00-00	1,4 kg
TRACKLUX-B-ATXL+2xLED.1h	NM/M	MidPower LEDs 5000K + 2xHighPower	1h	LiFePo4 6,4V/1,0Ah	334-B-017-04-00-00	1,3 kg
TRACKLUX-B-ATXL+2xLED.3h	NM/M	MidPower LEDs 5000K + 2xHighPower	3h	LiFePo4 6,4V/2,0Ah	334-B-018-04-00-00	1,4 kg

Page No.38

Wireless CENTRALTEST ELMAX-ATRF

Type	Version	Light Source	Duration	Battery	Order Code	Weight
TRACKLUX-ATRF.1h	NM/M	SAMSUNG MidPower LEDs 5000K	1h	LiFePo4 6,4V/1,0Ah	334-B-019-04-00-00	1,2 kg
TRACKLUX-ATRF.3h	NM/M	SAMSUNG MidPower LEDs 5000K	3h	LiFePo4 6,4V/2,0Ah	334-B-020-04-00-00	1,3 kg
TRACKLUX-A-ATRF+2xLED.1h	NM/M	MidPower LEDs 5000K + 2xHighPower	1h	LiFePo4 6,4V/1,0Ah	334-B-021-04-00-00	1,3 kg
TRACKLUX-A-ATRF+2xLED.3h	NM/M	MidPower LEDs 5000K + 2xHighPower	3h	LiFePo4 6,4V/2,0Ah	334-B-022-04-00-00	1,4 kg
TRACKLUX-B-ATRF+2xLED.1h	NM/M	MidPower LEDs 5000K + 2xHighPower	1h	LiFePo4 6,4V/1,0Ah	334-B-023-04-00-00	1,3 kg
TRACKLUX-B-ATRF+2xLED.3h	NM/M	MidPower LEDs 5000K + 2xHighPower	3h	LiFePo4 6,4V/2,0Ah	334-B-024-04-00-00	1,4 kg

Page No.44

CENTRAL BATTERY (CBS)

Type	CBS Version for	Light Source	Order Code	Weight
C.TRACKLUX 230V AC/DC	CBS NON-ADDRESSABLE	SAMSUNG MidPower LEDs 5000K	334-B-025-00-00-00	1,1 kg
C.TRACKLUX-A 230V AC/DC	CBS NON-ADDRESSABLE	MidPower LEDs 5000K + 2xHighPower	334-B-026-00-00-00	1,1 kg
C.TRACKLUX-B 230V AC/DC	CBS NON-ADDRESSABLE	MidPower LEDs 5000K + 2xHighPower	334-B-027-00-00-00	1,1 kg

DALI CENTRAL BATTERY (CBS)

Type	CBS Version for	Light Source	Order Code	Weight
C.TRACKLUX-DALI 230V AC	DALI CBS	SAMSUNG MidPower LEDs 5000K	334-B-028-00-00-00	1,1 kg

Page No.40

Addressable CENTRAL BATTERY (CBS) -ATXP ELMAX-PATROLUX

Type	CBS Version for	Light Source	Order Code	Weight
C.TRACKLUX-ATXPR 230V AC/DC	ATXP CBS ADDRESSABLE	SAMSUNG MidPower LEDs 5000K	334-B-031-00-00-00	1,1 kg
C.TRACKLUX-A-ATXPR 230V AC/DC	ATXP CBS ADDRESSABLE	MidPower LEDs 5000K + 2xHighPower	334-B-032-00-00-00	1,1 kg
C.TRACKLUX-B-ATXPR 230V AC/DC	ATXP CBS ADDRESSABLE	MidPower LEDs 5000K + 2xHighPower	334-B-033-00-00-00	1,1 kg

ARRISLUX



C.ARRISLUX2 / MULTIARRIS2-AT



C.ARRISLUX2-A+1xLED / MULTIARRIS2-AT-A+1xLED

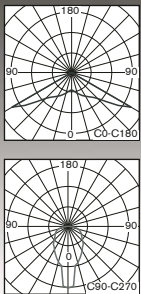

• Wall or ceiling mounted fixture in triangular shape for non-maintained/maintained (NM/M) or CBS (C) emergency lighting available in all following versions:

- **AUTOTEST** (-AT),
- **CENTRAL BATTERY** (C.ARRISLUX) for **non-addressable CBS** available also in 2 circuit version (1 circuit for picto illuminaton and another circuit for bottom HighPower LED if present - 2x230V version) - Page No.44
- Conforming to the requirement of EN60598-2-22, EN1838, EN62034

• Design:

- Metal sheet base painted in RAL9003 colour
- **IMPACT** resistant polycarbonate diffuser (the legend must be ordered as seprate item)

• elegantné núdzové svietidlo "trojuholnikového" tvaru pre trvalé/netrvalé (NM/M) alebo (C) CBS centrálne napájané núdzové osvetlenie dostupné vo verziách pre:

- **AUTOTEST** (-AT),
- **CENTRAL BATTERY** (C.ARRISLUX) pre **neadresovateľné CBS** (str.44)
- spĺňa požiadavky európskej normy EN 60598-2-22, EN1838, EN62034

• konštrukcia:

- základňa z ocelového plechu v bielej farbe RAL9003
- nerozbitný polykarbonátový svetelno-činný (piktogram musí byť objednaný samostatne)

STANDARD FEATURES

STANDARDNÁ VÝBAVA

- **High efficient (150lm/W, 5000K) LONGLIFE LEDs (>100.000h)**
- **High-Power Bottom LED 120lm/W** for floor either **ESCAPE ROOT** illumination (valid only for all "-A+1xLED" versions) or **SPOT BEAMER** for fire fighting equipment illumination 5lx level (valid only for all "-B+1xLED" versions)
- **NEW Advanced Electronics**
- **LONGLIFE NiMH battery**
- **Installation Mode** (battery protection, for more details look up page No.51)
- **Intelligent battery charging** (intermittent charging, look up page No.51)
- **DIP Switch** allowing to preset following functions:
 - **ECO Mode** (dimming 10%-100%, for more details look up page No.51)
 - **ENERGY Saving Mode** (picto illumination 2cd/m² or 200cd/m², look up page 51)
- LEDs indicating presence of power supply and signaling failures & TEST button

- **vysoko účinné LED (150lm/W, 5000K) so životnosťou min.100000h**
- **Výkonné LED 120lm/W pre osvetlenie únikovej cesty na podlahe** (len pri všetkých "-A+1xLED" verziách) alebo pre **SPOT osvetlenie** hasiaceho prístroja/hydrantu >5lx (len pri všetkých "-B+1xLED" verziách)
- **progressívna elektronická jednotka**
- **LONGLIFE NiMH batéria**
- **Inštalčný mód** (ochrana batérie, pozri aj str.51)
- **Inteligentné nabíjanie batérie** ("intermittent" nabíjanie, pozri aj str.51)
- **DIP prepínač** umožňujúci prednastavenie funkcií:
 - **ECO Mód** (stmievanie 10%-100%, pozri aj str.51)
 - **ENERGY Saving Mód** (osvetlenie pikto na 2cd/m² alebo 200cd/m², pozri aj str.51)
- signalizácia LED a TEST tlačítko

Valid for all **+1xLED-A versions** / wall mounting
Pre všetky verzie **+1xLED-A** / montáž na stenu

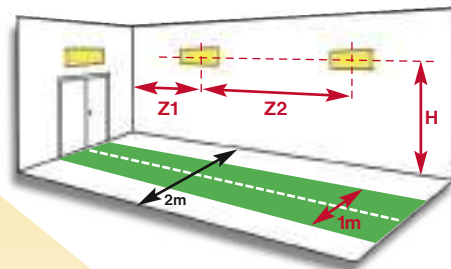

For corridor areas up to 2m in width the escape route should be 1m wide. In the central line min 1lux and in the whole escape route area min 0,5lux levels are required (EN1838).

1LX SPACING TABLE / ROZMIESTNENIE PRE 1LX

H (m)	Z1 (m)	Z2 (m)
2,30	10	20
2,75	8	16

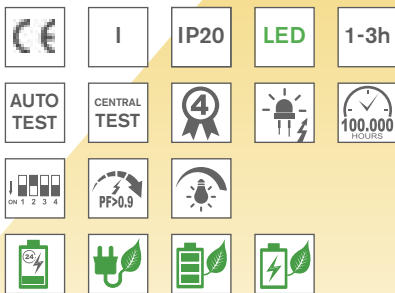

Input Power:

- 7,0W/ 7,4VA (maintained M)
- 2,0W/ 3,9VA (non-maintained NM)
- 6,1W/ 6,3VA (CBS)

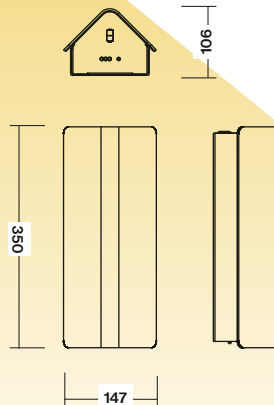

CEILING OR WALL MOUNTING WITH OPTIONAL BOTTOM LED ARRISLUX



C.ARRISLUX2-B+1xLED / MULTIARRIS2-AT-B+1xLED



- **Self-adhesive LEGENDS are not included in standard package. MUST BE ORDERED AS SEPARATE ITEM !**
- Viewing Distance: 22m
- Complying ISO7010
- Legend luminance >500cd/m² (white)
- **Samolepiace piktogramy nie sú súčasťou štandardného balenia svietidla. MUSIA BYŤ OBJEDNANÉ AKO SAMOSTATNÁ POLOŽKA !**
- rozoznatelnosť piktogramu: 22m
- v súlade s ISO7010
- jas piktogramu >500cd/m² (biela)



Legends / Piktogramy

Optional Item / Príplatok	Order Code / Objednávaci kód
Picto H/J Horizontal Mounting / horizontálne	324-B-000-01-00-00
Picto I/I Horizontal Mounting / horizontálne	324-B-000-02-00-00
Picto H/J Vertical Mounting / vertikálne	324-B-000-03-00-00
Picto J/H Vertical Mounting / vertikálne	324-B-000-04-00-00
Picto I/I Vertical Mounting / vertikálne	324-B-000-05-00-00
Picto Z1/Z1 Vertical Mounting / vertikálne	324-B-000-06-00-00
Picto Z2/Z2 Vertical Mounting / vertikálne	324-B-000-07-00-00
Picto Z1/Z2 Vertical Mounting / vertikálne	324-B-000-08-00-00



Page No.32

AUTOTEST -AT NM/M

Type	Light Source	Light Flux / Emergency mode	Battery	Order Code	Weight
MULTIARRIS2-AT.1h	MidPower LEDs	NA	LiFePo4 6,4V/1,0Ah	324-B-001-04-00-00	1,4 kg
MULTIARRIS2-AT.3h	MidPower LEDs	NA	LiFePo4 6,4V/2,0Ah	324-B-002-04-00-00	1,5 kg
MULTIARRIS2-AT-A+1xLED.1h	MidPower LEDs+1xHighPower	110 lm / 110 lm	LiFePo4 6,4V/1,0Ah	324-B-003-04-00-00	1,5 kg
MULTIARRIS2-AT-B+1xLED.1h	MidPower LEDs+1xHighPower	110 lm / 110 lm	LiFePo4 6,4V/1,0Ah	324-B-004-04-00-00	1,5 kg

Page No.44

CENTRAL BATTERY (CBS)

Type	Version	Light Source	Light Flux	Order Code	Weight
C.ARRISLUX2 230V AC/DC	CBS NON-ADDRESSABLE	MidPower LEDs	NA	324-B-005-00-00-00	1,2 kg
C.ARRISLUX2-A+1xLED 230V AC/DC	CBS NON-ADDRESSABLE	MidPower LEDs+1xHighPower	110 lm	324-B-006-00-00-00	1,3 kg
C.ARRISLUX2-B+1xLED 230V AC/DC	CBS NON-ADDRESSABLE	MidPower LEDs+1xHighPower	110 lm	324-B-007-00-00-00	1,3 kg

Look up pages No. 210-217 for 1lx Spacing tables
Pozri str.210-217 pre rozmiestnenie svietidiel na dosiahnutie 1lx

TRIPLELUX



← → 32m

C.TRIPLELUX2 / MULTITRIPLE2-AT



C.TRIPLELUX2-A+1xLED / MULTITRIPLE2-AT-A+1xLED

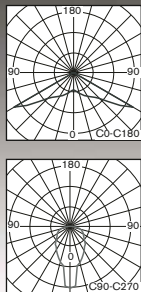

• Wall or ceiling mounted fixture in triangular shape for non-maintained/maintained (NM/M) or CBS (C) emergency lighting available in all following versions:

- **AUTOTEST** (-AT),
- **CENTRAL BATTERY** (C.TRIPLELUX) for **non-addressable CBS** available also in 2 circuit version (1 circuit for legend illumination and another circuit for bottom HighPower LED if present) - see also page No.44
- Conforming to the requirement of EN60598-2-22, EN1838, EN62034
- Design:
 - Metal sheet base painted in RAL9003 colour
 - Acrylic diffuser (the legend must be ordered as separate item)

- elegantné núdzové svietidlo "trojuholnikového" tvaru pre trvalé/netrvalé (NM/M) alebo (C) CBS centrálné napájané núdzové osvetlenie dostupné vo verziách pre:
 - **AUTOTEST** (-AT),
 - **CENTRAL BATTERY** (C.TRIPLELUX) pre **neadresovateľné CBS** (str.44) je v ponuke aj ako dvojokruhovú, tj osvetlenie pikto a spodnej LED má svoj vlastný predradník

- spĺňa požiadavky európskej normy EN 60598-2-22, EN1838, EN62034
- konštrukcia:
 - základňa z ocelového plechu v bielej farbe RAL9003
 - svetelno-činný z plexi (piktogram musí byť objednaný samostatne)

STANDARD FEATURES

STANDARDNÁ VÝBAVA

- **High efficient (150lm/W, 5000K) LONGLIFE LEDs (>100.000h)**
- **High-Power Bottom LED 120lm/W** for floor either **ESCAPE ROOT** illumination (valid only for all "-A+1xLED" versions) or **SPOT BEAMER** for fire fighting equipment illumination 5lx level (valid only for all "-B+1xLED" versions)
- **NEW Advanced Electronics**
- **LONGLIFE battery**
- **Installation Mode** (battery protection, for more details look up page No.51)
- **Intelligent battery charging** (intermittent charging, look up page No.51)
- **DIP Switch** allowing to preset following functions:
 - **ECO Mode** (dimming 10%-100%, for more details look up page No.51+126)
 - **ENERGY Saving Mode** (picto illumination 2cd/m² or 200cd/m², look up page 51+126)
- LEDs indicating presence of power supply and signaling failures & TEST button
- **vysoko účinné LED (150lm/W, 5000K) so životnosťou min.100000h**
- **Výkonné LED 120lm/W** pre osvetlenie únikovej cesty na podlahe (len pri všetkých "-A+1xLED" verziách) alebo pre **SPOT osvetlenie** hasiaceho prístroja / hydrantu >5lx (len pri všetkých "-B+1xLED" verziách)
- **progressívna elektronická jednotka**
- **LONGLIFE batéria**
- **Inštaláčny mód** (ochrana batérie, pozri aj str.51)
- **Inteligentné nabíjanie batérie** ("intermittent" nabíjanie, pozri aj str.51)
- **DIP prepínač** umožňujúci prednastavenie funkcií:
 - **ECO Mód** (stmievanie 10%-100%, pozri aj str.51+126)
 - **ENERGY Saving Mód** (osvetlenie pikto na 2cd/m² alebo 200cd/m², pozri aj str.51+126)
- signalizácia LED a TEST tlačítko

Valid for all **+1xLED-A versions** / wall mounting
Pre všetky verzie **+1xLED-A** / montáž na stenu

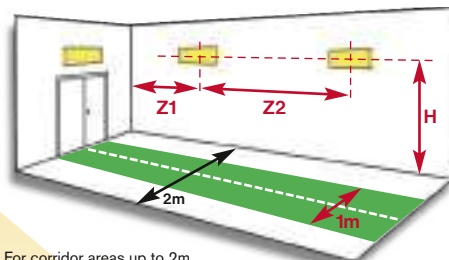

For corridor areas up to 2m in width the escape route should be 1m wide. In the central line min 1lux and in the whole escape route area min 0,5lux levels are required (EN1838).

1LX SPACING TABLE / ROZMIESTNENIE PRE 1LX

H (m)	Z1 (m)	Z2 (m)
2,30	10	20
2,75	8	16

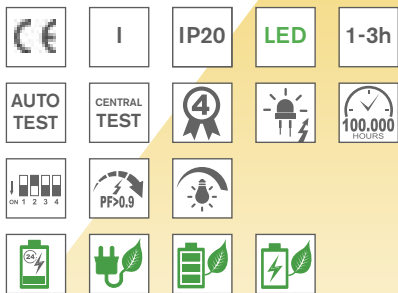

Input Power:

- 7,0W/ 7,4VA (maintained M)
- 2,0W/ 3,9VA (non-maintained NM)
- 9,6W/ 10,6VA (CBS)

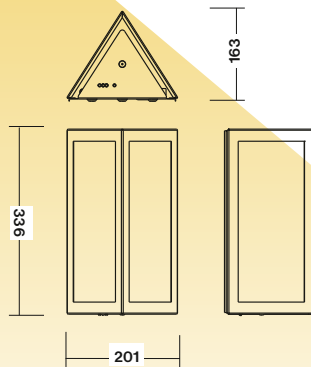

CEILING OR WALL MOUNTING WITH OPTIONAL BOTTOM LED TRIPLELUX



C.TRIPLELUX2-B+1xLED / MULTITRIPLE2-AT-B+1xLED

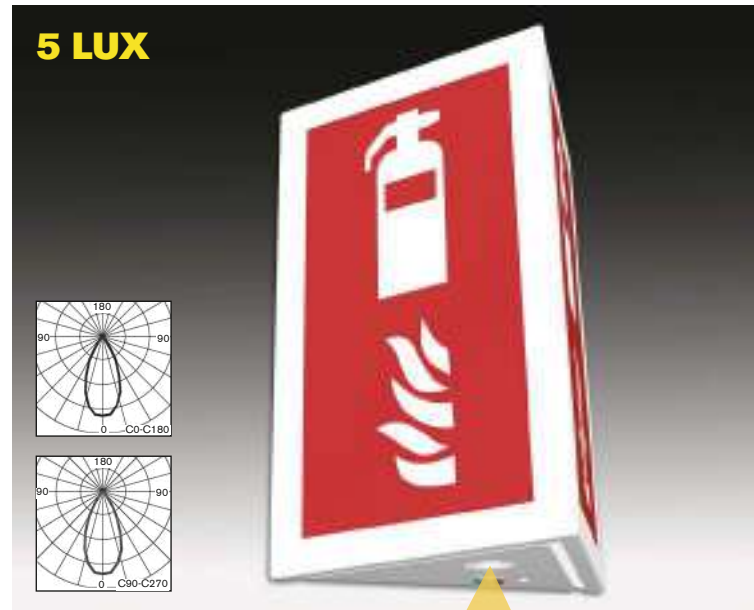

- The self-adhesive LEGENDS are not included in standard package. **MUST BE ORDERED AS SEPARATE ITEM !**
- 2pcs/fixture are needed
- Viewing Distance: 32m
- Complying ISO7010
- Legend luminance >500cd/m² (white)
- Samolepiace piktogramy nie sú súčasťou štandardného balenia svetidla. **MUSIA BYŤ OBJEDNANÝ AKO SAMOSTATNÁ POLOŽKA !**
- potrebné 2ks/svietidlo
- rozoznatelnosť piktogramu: 32m
- v súlade s ISO7010
- jas piktogramu >500cd/m² (biela)

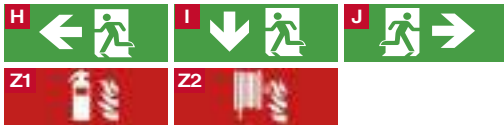

Legends / Piktogramy

Optional Item / Pripatok	Order Code / Objednávaci kód
Picto H Horizontal Mounting / horizontálne	41-B-200-00-00-01
Picto I Horizontal Mounting / horizontálne	41-B-200-00-00-02
Picto J Horizontal Mounting / horizontálne	41-B-200-00-00-03
Picto H Vertical Mounting / vertikálne	41-B-200-00-00-04
Picto I Vertical Mounting / vertikálne	41-B-200-00-00-05
Picto J Vertical Mounting / vertikálne	41-B-200-00-00-06
Picto Z1 Vertical Mounting / vertikálne	41-B-200-00-00-07
Picto Z2 Vertical Mounting / vertikálne	41-B-200-00-00-08

Page No.162

AUTOTEST -AT NM/M

Type	Light Source	Light Flux / Emergency mode	Battery	Order Code	Weight
MULTITRIPLE2-AT.1h	MidPower LEDs	NA	LiFePo4 6,4V/1,0Ah	41-B-100-04-00-00	1,4 kg
MULTITRIPLE2-AT.3h	MidPower LEDs	NA	LiFePo4 6,4V/2,0Ah	41-B-101-04-00-00	1,5 kg
MULTITRIPLE2-AT-A+1xLED.1h	MidPower LEDs+1xHighPower	110 lm / 110 lm	LiFePo4 6,4V/1,0Ah	41-B-102-04-00-00	1,5 kg
MULTITRIPLE2-AT-B+1xLED.1h	MidPower LEDs+1xHighPower	110 lm / 110 lm	LiFePo4 6,4V/1,0Ah	41-B-103-04-00-00	1,5 kg

Page No.174

CENTRAL BATTERY (CBS)

Type	Version	Light Source	Light Flux	Order Code	Weight
C.TRIPLELUX2 230V AC/DC	CBS NON-ADDRESSABLE	MidPower LEDs	NA	41-B-104-00-00-00	1,2 kg
C.TRIPLELUX2-A+1xLED 230V AC/DC	CBS NON-ADDRESSABLE	MidPower LEDs+1xHighPower	110 lm	41-B-105-00-00-00	1,3 kg
C.TRIPLELUX2-B+1xLED 230V AC/DC	CBS NON-ADDRESSABLE	MidPower LEDs+1xHighPower	110 lm	41-B-106-00-00-00	1,3 kg
C.TRIPLELUX2-B+1xLED 2x230V AC/DC	CBS NON-ADDRESSABLE	MidPower LEDs+1xHighPower	110 lm	41-B-107-00-00-00	1,3 kg

Look up pages No. 210-217 for 1lx Spacing tables
Pozri str.210-217 pre rozmiestnenie svetidiel na dosiahnutie 1lx

WALL MOUNTING L & XL VIEWING DISTANCE LEGEND L/XL SIZE



Most advanced "V" twin LED light source with perfect light distribution. It is equipped with high efficient (150lm/W) LONGLIFE LEDs with the lifetime >100.000h

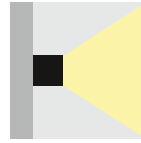

- **Big Viewing Distance** IP65 wall mounted powerful LED fixture for all non-maintained/maintained (NM/M) or CBS (C) emergency lighting, especially designed for application such as **train/metro/bus stations, subways, football stadiums, parking garages**, etc. available in all following versions:
 - **AUTOTEST** (-AT)
 - **DALI**
 - **Wireless CENTRALTEST** (-ATRF) for **ELMAX Wireless** system (page No.38)
 - **CENTRALTEST** (-ATXL) for ELMAX-Look Mini system (look up also page 36)
 - **CENTRAL BATTERY** (C.xx) for **non-addressable CBS** (page 44)
 - **CENTRAL BATTERY** (-ATXP) for system **ELMAX-PATROLUX Mini & Addressable CBS** (look up also page No.40)
- Conforming to the requirement of EN60598-2-22, EN1838, EN62034
- Design:
 - cover made from polycarbonate
 - Base made from ABS

- nástenné núdzové svietidlo s veľkým piktoqramom pre aplikácie, kde je vyžadovaná **veľká pozorovacia vzdialenosť a IP65 ako napr. stanice, podchody, štadióny, parkovacie domy** a pod.
- pre trvalé/netrválne (NM/M) alebo (C) centrálné napájané núdzové osvetlenie dostupné vo verziách pre:
 - **AUTOTEST** (-AT)
 - **DALI**
 - **bezdrôtový CENTRALTEST** (-ATRF) pre ELMAX Wireless systém (pozri str.38)
 - **CENTRALTEST** (-ATXL) pre systém ELMAX-LOOK Mini (pozri str.36)
 - **CENTRAL BATTERY** (C.xx) pre **neadresovateľné CBS** (str. 44)
 - **CENTRAL BATTERY** (-ATXP) pre systém **ELMAX-PATROLUX Mini s adresovateľnou CBS** (pozri str. 40)
- spĺňa požiadavky európskej normy EN 60598-2-22, EN1838, EN62034
- konštrukcia:
 - kryt svietidla vyrobený z polykarbonátu
 - základňa svietidla - ABS

STANDARD FEATURES

STANDARDNÁ VÝBAVA

- **High efficient (150lm/W) LONGLIFE LEDs 5000K (>100.000h)**
- **NEW Advanced Electronics**
- **LONGLIFE LiFePo4 battery**
- **Installation Mode** (battery protection, for more details look up page No.51-135)
- **Intelligent battery charging** (intermittent charging, look up page No.51-135)
- **DIP Switch** allowing to preset following functions:
 - **ECO Mode** (dimming 10%-100%, for more details look up page No.51-135)
 - **ENERGY Saving Mode** (picto illumination 2cd/m² or 200cd/m², page 51-135)
- Addressable CENTRALTEST communication module (for ATXL, ATXP, ATRF only)
- LEDs indicating both presence of power supply and signaling failures & TEST button
- both side and back side cable entries (bushings)
- **vysoko účinné LED 5000K (150lm/W) so životnosťou min.100000h**
- **progresívna elektronická jednotka**
- **LONGLIFE LiFePo4 batéria**
- **Inštalčný mód** (ochrana batérie, pozri aj str.51-135)
- **Inteligentné nabíjanie batérie** ("intermittent" nabíjanie, pozri aj str.51-135)
- **DIP prepínač** umožňujúci prednastavenie funkcií:
 - **ECO Mód** (stmievanie 10%-100%, pozri aj str.51-135)
 - **ENERGY Saving Mód** (osvetlenie pikto na 2cd/m² alebo 200cd/m², pozri aj str.51-135)
- adresovateľný CENTRALTEST komunikačný modul (len pre ATXL, ATXP, ATRF verzie)
- signalizácia LED a TEST tlačítko
- zadné a bočné prechodky IP65 na vstup vodičov

OPTIONAL ACCESSORIES

PRÍPLATKY

- **LEGEND / Picto** must be ordered as separate item (look up page 134)
- piktoqram musí byť objednaný samostatne, nie je súčasťou svietidla (look up page 134)



← → 74m

XLegend Size



← → 46m
74m

Legend & XLegend



Dimensions in the bracket are valid for XLegend Size
Rozmery v zátvorke platie pre veľkosť XLegend

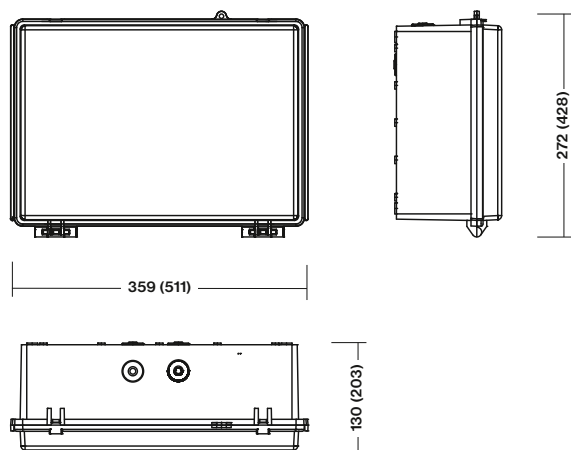

WALL MOUNTING L & XL VIEWING DISTANCE LEGEND L/XL SIZE

Light source	LED 5000K >500cd/m ² (white luminance) >200cd/m ² (average luminance)
Installed load L Size	6.5W/6.9VA (maintained M) 2.8W/4.3VA (non-maintained NM) 5.7W/6.0VA (CBS)
Installed load XL Size	9.4W/11.9VA (maintained M) 2.8W/4.3VA (non-maintained NM) 5.7W/6.0VA (CBS)
Protection index	IP65
Viewing distance	46m (L Size) / 74m (XL Size)

Page No.32

AUTOTEST -AT NM/M

Type	Version	Light Source	Duration	Battery	Order Code	Weight
Legend-AT.1h	NM/M	SAMSUNG MidPower LEDs 5000K	1h	LiFePo4 6,4V/1,0Ah	329-B-001-04-00-00	1,5 kg
Legend-AT.3h	NM/M	SAMSUNG MidPower LEDs 5000K	3h	LiFePo4 6,4V/2,0Ah	329-B-002-04-00-00	1,6 kg
XLegend-AT.1h	NM/M	SAMSUNG MidPower LEDs 5000K	1h	LiFePo4 6,4V/2,0Ah	329-B-101-04-00-00	2,5 kg
XLegend-AT.3h	NM/M	SAMSUNG MidPower LEDs 5000K	3h	LiFePo4 6,4V/4,5Ah	329-B-102-04-00-00	2,6 kg

DALI SELF-CONTAINED

Type	Version	Light Source	Duration	Battery	Order Code	Weight
Legend-DALI.1h	NM/M	SAMSUNG MidPower LEDs 5000K	1h	LiFePo4 6,4V/1,0Ah	329-B-003-04-00-00	1,5 kg
Legend-DALI.3h	NM/M	SAMSUNG MidPower LEDs 5000K	3h	LiFePo4 6,4V/2,0Ah	329-B-004-04-00-00	1,6 kg
XLegend-DALI.1h	NM/M	SAMSUNG MidPower LEDs 5000K	1h	LiFePo4 6,4V/2,0Ah	329-B-103-04-00-00	2,5 kg
XLegend-DALI.3h	NM/M	SAMSUNG MidPower LEDs 5000K	3h	LiFePo4 6,4V/4,5Ah	329-B-104-04-00-00	2,6 kg

Page No.36

CENTRALTEST ELMAX-LOOK

Type	Version	Light Source	Duration	Battery	Order Code	Weight
Legend-ATXL.1h	NM/M	SAMSUNG MidPower LEDs 5000K	1h	LiFePo4 6,4V/1,0Ah	329-B-005-04-00-00	1,5 kg
Legend-ATXL.3h	NM/M	SAMSUNG MidPower LEDs 5000K	3h	LiFePo4 6,4V/2,0Ah	329-B-006-04-00-00	1,6 kg
XLegend-ATXL.1h	NM/M	SAMSUNG MidPower LEDs 5000K	1h	LiFePo4 6,4V/2,0Ah	329-B-105-04-00-00	2,5 kg
XLegend-ATXL.3h	NM/M	SAMSUNG MidPower LEDs 5000K	3h	LiFePo4 6,4V/4,5Ah	329-B-106-04-00-00	2,6 kg

Page No.38

Wireless CENTRALTEST ELMAX-ATRF

Type	Version	Light Source	Duration	Battery	Order Code	Weight
Legend-ATRF.1h	NM/M	SAMSUNG MidPower LEDs 5000K	1h	LiFePo4 6,4V/1,0Ah	329-B-007-04-00-00	1,5 kg
Legend-ATRF.3h	NM/M	SAMSUNG MidPower LEDs 5000K	3h	LiFePo4 6,4V/2,0Ah	329-B-008-04-00-00	1,6 kg
XLegend-ATRF.1h	NM/M	SAMSUNG MidPower LEDs 5000K	1h	LiFePo4 6,4V/2,0Ah	329-B-107-04-00-00	2,5 kg
XLegend-ATRF.3h	NM/M	SAMSUNG MidPower LEDs 5000K	3h	LiFePo4 6,4V/4,5Ah	329-B-108-04-00-00	2,6 kg

Page No.44

CENTRAL BATTERY (CBS)

Type	CBS Version for	Light Source	Order Code	Weight
C.Legend 230V AC/DC	CBS NON-ADDRESSABLE	SAMSUNG MidPower LEDs 5000K	329-B-009-00-00-00	1,4 kg
C.XLegend 230V AC/DC	CBS NON-ADDRESSABLE	SAMSUNG MidPower LEDs 5000K	329-B-109-00-00-00	2,4 kg

DALI CENTRAL BATTERY (CBS)

Type	CBS Version for	Light Source	Order Code	Weight
C.Legend -DALI 230V AC	DALI CBS	SAMSUNG MidPower LEDs 5000K	329-B-010-00-00-00	1,4 kg
C.XLegend -DALI 230V AC	DALI CBS	SAMSUNG MidPower LEDs 5000K	329-B-110-00-00-00	2,4 kg

Page No.40

Addressable CENTRAL BATTERY (CBS) -ATXP ELMAX-PATROLUX

Type	CBS Version for	Light Source	Order Code	Weight
C.Legend -ATXPR 230V AC/DC	ATXP CBS ADDRESSABLE	SAMSUNG MidPower LEDs 5000K	329-B-011-00-00-00	1,4 kg
C.XLegend -ATXPR 230V AC/DC	ATXP CBS ADDRESSABLE	SAMSUNG MidPower LEDs 5000K	329-B-111-00-00-00	2,4 kg

LEGEND L/XL SIZE



46m
 74m
 Legend + XLegend

The legend itself is separate plexi sheet with picto printed on its surface. It is installed inside of the fixture in order to be resistant against either vandalism or any external impact.

Piktogram je samostatné plexi s potlačou. Je inštalované zvnútra svietidla, aby bol samotný piktogram chránený voči poškodeniu napr.vandalizmom alebo iným vonkajším vplyvom.



- ACRYLIC legend complying ISO7010 must be ordered as separate item, it is not standard accessory
- Viewing Distance: 46m (**XLegend** versions)
- Legend luminance > 500cd/m² (white)
- PLEXI piktogram v súlade s ISO7010, musí byť objednané ako samostatná položka, nie je súčasťou svietidla
- rozoznatelnosť piktogramu: 46m (**XLegend** verzie)
- jas piktogramu > 500cd/m² (biela)

Optional Item / Pripatok	Order Code / Objednávaci kód
Picto „H“ / pikto „H“ (XLegend versions)	329-B-000-01-00-01
Picto „I“ / pikto „I“ (XLegend versions)	329-B-000-01-00-02
Picto „J“ / pikto „J“ (XLegend versions)	329-B-000-01-00-03
Picto „O“ / pikto „O“ (XLegend versions)	329-B-000-01-00-04
Picto „K“ / pikto „K“ (XLegend versions)	329-B-000-01-00-05
Picto „L“ / pikto „L“ (XLegend versions)	329-B-000-01-00-06
Picto „M“ / pikto „M“ (XLegend versions)	329-B-000-01-00-07
Picto „N“ / pikto „N“ (XLegend versions)	329-B-000-01-00-08
Picto „Z1“ / pikto „Z1“ (XLegend versions)	329-B-000-01-00-09
Picto „Z2“ / pikto „Z2“ (XLegend versions)	329-B-000-01-00-10



- ACRYLIC legend complying ISO7010 must be ordered as separate item, it is not standard accessory
- Viewing Distance: 74m (**Legend** versions)
- Legend luminance > 500cd/m² (white)
- PLEXI piktogram v súlade s ISO7010, musí byť objednané ako samostatná položka, nie je súčasťou svietidla
- rozoznatelnosť piktogramu: 74m (**Legend** verzie)
- jas piktogramu > 500cd/m² (biela)

Optional Item / Pripatok	Order Code / Objednávaci kód
Picto „H“ / pikto „H“ (Legend versions)	329-B-000-02-00-01
Picto „I“ / pikto „I“ (Legend versions)	329-B-000-02-00-02
Picto „J“ / pikto „J“ (Legend versions)	329-B-000-02-00-03
Picto „O“ / pikto „O“ (Legend versions)	329-B-000-02-00-04
Picto „K“ / pikto „K“ (Legend versions)	329-B-000-02-00-05
Picto „L“ / pikto „L“ (Legend versions)	329-B-000-02-00-06
Picto „M“ / pikto „M“ (Legend versions)	329-B-000-02-00-07
Picto „N“ / pikto „N“ (Legend versions)	329-B-000-02-00-08
Picto „Z1“ / pikto „Z1“ (Legend versions)	329-B-000-02-00-09
Picto „Z2“ / pikto „Z2“ (Legend versions)	329-B-000-02-00-10



DIP-SWITCH SET-UP FEATURES LEGEND L/XL SIZE



**ENERGY SAVING
ECO MODE
SET UP**



**2/200
cd/m²**

**NO
AT**

DIP SWITCH FEATURES No.1-4

DIP PREPÍNAČ č.1-4 - FUNKCIE

SELF-CONTAINED BATTERY VERSIONS

**NORMAL MODE
230V MAINS**

**EMERGENCY MODE
BATTERY**

**1 LUX
ESCAPE ROUTE
APPLICATION**

**1 LUX
ESCAPE ROUTE
APPLICATION**



NO LEGEND / BEZ PIKTOGRAMU
ESCAPE ROUTE ILLUMINATION

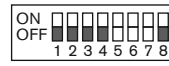

DEFFAULT SETT./ PREDNASTAVENÉ
Full Power for ESCAPE SIGN Applicaton
BRIGHTNESS > 200cd/m²

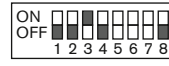

ECO MODE 50% (in 230V mode)
EMERGENCY MODE LEGEND
BRIGHTNESS > 200cd/m²

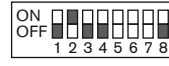

ECO MODE 25% (in 230V mode)
EMERGENCY MODE LEGEND
BRIGHTNESS > 200cd/m²

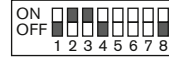

ECO MODE 10% (in 230V mode)
EMERGENCY MODE LEGEND
BRIGHTNESS > 200cd/m²



ENERGY SAVING (in emerg.mode)
LEGEND BRIGHTNESS > 2cd/m²
JAS PIKTOGRAMU > 2cd/m²



ENERGY SAVING (in emerg.mode)
ECO MODE 50% (in 230V mode)
LEGEND BRIGHTNESS > 2cd/m²

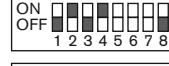

ENERGY SAVING (in emerg.mode)
ECO MODE 25% (in 230V mode)
LEGEND BRIGHTNESS > 2cd/m²



ENERGY SAVING (in emerg.mode)
ECO MODE 10% (in 230V mode)
LEGEND BRIGHTNESS > 2cd/m²



**M /
NM**

**AT /
ATXL**

DIP SWITCH FEATURES No.5-8

DIP PREPÍNAČ č.5-8 - FUNKCIE



**INSTALLATION
MODE
SET UP**

**M /
NM**

**NON-MAINTAINED /
MAINTAINED
MODE
SET UP**

**AT /
ATXL**

**AUTOTEST /
CENTRALTEST
MODE
SET UP**

**NO
AT**

**NO-AUTOTEST
MODE
SET UP**

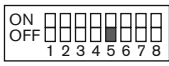

DEFFAULT SETTING / PREDNASTAVENÉ
OFF - ACTIVATED
ON - DEACTIVATED

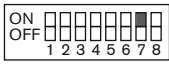

DEFFAULT SETTING / PREDNASTAVENÉ
ON - MAINTAINED
OFF - NON-MAINTAINED

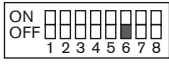

DEFFAULT SETTING / PREDNASTAVENÉ
OFF - AUTOTEST
ON - CENTRALTEST

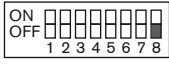

DEFFAULT / PREDNASTAVENÉ
OFF - AUTOTEST ACTIVE
ON - NO-AUTOTEST

TO SEE THE CHANGE PUSH EITHER TEST BUTTON OR DISCONNECT THE FIXTURE FROM BOTH THE MAINS 230V AND BATTERY
Po prestavení stlačte TEST alebo odpojte batériu a 230V napájanie na aktiváciu zmeny

DIP SWITCH FEATURES No.2-3

DIP PREPÍNAČ č.2-3 - FUNKCIE

CBS CENTRAL BATTERY VERSIONS

**CBS
CENTRAL BATTERY**

**1 LUX
ESCAPE ROUTE
APPLICATION**



FULL POWER
PLNÝ VÝKON

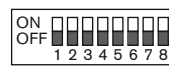

FULL POWER
LEGEND BRIGHTNESS > 200cd/m²
JAS PIKTOGRAMU > 200cd/m²

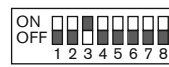

ECO MODE 50%

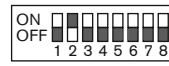

ECO MODE 25%

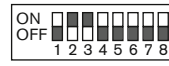

ECO MODE 10%
LEGEND BRIGHTNESS > 2cd/m²
JAS PIKTOGRAMU > 2cd/m²

TO SEE THE CHANGE PUSH EITHER TEST BUTTON OR DISCONNECT THE FIXTURE FROM BOTH THE MAINS 230V AND BATTERY
Po prestavení stlačte TEST alebo odpojte batériu a 230V napájanie na aktiváciu zmeny

CEILING MOUNTING LEDLUX-SPOT2

Thanks to the special design of all LED lenses we can cover all kind of applications such as corridors (escape route) and open areas (escape route lighting)

Vďaka špeciálnym LED šošovkám dokážeme pokryť všetky typy aplikácií ako sú chodby / koridory (escape route) a otvorené priestory (anti-panic)



Light source	LED 5000K
Installed load	5.5W/5.7VA (maintained M) 1.9W/4.0VA (non-maintained NM) 3.5W/4.6VA (CBS)
Housing colour	RAL9003 White RAL9006 Grey
Application	Anti-panic lighting
Max room illumination	up to 126m² > 0.5lx

Light source	LED 5000K
Installed load	5.5W/5.7VA (maintained M) 1.9W/4.0VA (non-maintained NM) 3.5W/4.6VA (CBS)
Housing colour	RAL9003 White RAL9006 Grey
Application	Escape route lighting
Max luminaire spacing	up to 23,5m > 1lx



Perfect Modern Orientated Shape allowing you to use it in all kind of applications. Equipped with HighPower perfect quality LED made by CREE

Perfektný tvar telesa svietidla ho predurčuje k použitiu v moderných interiéroch súčasnosti. Vybavené výkonnou LED od renomovaného výrobcu CREE



AUTOTEST/CENTRALTEST
(only all MULTILED-SPOT-AT/ATXL/ATRF versions):
Monitor status by 3x LEDs and TEST button

AUTOTEST/CENTRALTEST
(len pre všetky MULTILED-SPOT-AT/ATXL/ATRF):
3x LED pre signalizáciu stavu svietidla a TEST tlačítko

"ONE HAND" tool free installation friendly springs allowing easy and fast recessed installation of the luminaire

Špeciálne tvarované úchytné pružiny dovoľujúce pohodlnú montáž svietidla do stropu jednou rukou bez nutnosti použitia dodatočných nástrojov

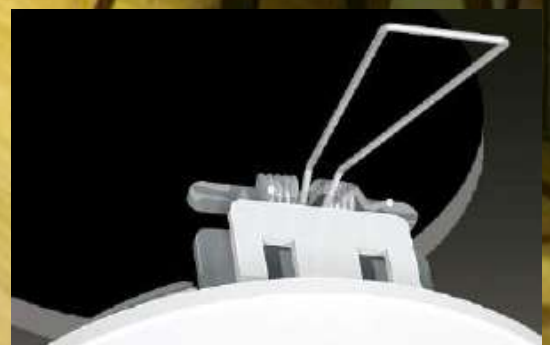

ASSORTMENT LEDLUX-SPOT2

LOW CEILING Applications <4m

LEDLUX-SPOT2 type serie is equipped with the combination of HighPower LED and sophisticated optics. Thanks to the both maximum efficiency and optimal light distribution result in the need for a low number of luminaires for emergency lighting in conformity with relevant standards. It is completely independent of general lighting. Thanks to LEDLUX-SPOT2 design the installation and maintenance is quick and simple. The luminaire proves its application flexibility with its range of installation options.

Moderný a nenápadný design vychádzajúci z kvalitných materiálov predurčuje svietidlo LEDLUX-SPOT2 pre núdzové osvetlenie v súlade s relevantnými normami plne nezávislým na hlavnom osvetlení. Svietidlá sú vybavené vyváženou kombináciou HighPower LED a špeciálnej optiky, čo zaručuje maximálnu účinnosť a optimálnu distribúciu svetla. Vďaka tomu je potrebný malý počet núdzových svietidiel pre vašu aplikáciu. LEDLUX-SPOT2 dokazuje svoju aplikáciu flexibilitu vďaka širokej typovej rade s rôznymi inštaláčnymi možnosťami.

Light source	LED 5000K
Installed load	5.5W/5.7VA (maintained M) 1.9W/4.0VA (non-maintained NM) 3.5W/4.6VA (CBS)
Housing colour	RAL9003 White RAL9006 Grey
Application	Escape route lighting Anti-panic lighting

NÍZKY STROP Aplikácia <4m



C.LEDLUX-SPOT-V-A
MULTILED-SPOT-V-A
(Page No.140)



C.LEDLUX-SPOT-P-A / MULTILED-SPOT-P-A
(Page No.146)



C.LEDLUX-SPOT-V-B
MULTILED-SPOT-V-B
(Page No.144)



C.LEDLUX-SPOT-P-B / MULTILED-SPOT-P-B
(Page No.150)

HIGH CEILING Applications >4m

HIGH CEILING application LEDLUX-SPOT2 HCA/HCB type series is equipped with the combination of all 2xHigh-Power LEDs, sophisticated optics and powerful battery. Thanks to all the high light output, maximum efficiency and optimal light distribution result in the need for a low number of luminaires for high ceiling application emergency lighting in conformity with relevant standards. It is completely independent of general lighting. Thanks to LEDLUX-SPOT2 HCA/HCB design the installation and maintenance is quick and simple.

Typová rada LEDLUX-SPOT2 HCA/HCB je určená pre núdzové osvetlenie priestorov s vysokou výškou stropu. Moderný a nenápadný design vychádzajúci z kvalitných materiálov predurčuje svietidlo LEDLUX-SPOT2 pre núdzové osvetlenie v súlade s relevantnými normami plne nezávislým na hlavnom osvetlení. Svietidlá sú vybavené vyváženou kombináciou 2xHighPower LED, špeciálnej optiky a výkonnej batérie, čo zaručuje vysoký svetelný tok, maximálnu účinnosť a optimálnu distribúciu svetla. Vďaka tomu je potrebný malý počet núdzových svietidiel pre vašu aplikáciu. Inštalácia a údržba svietidiel je rýchla a jednoduchá.

Light source	LED 5000K 410lm
Housing colour	RAL9003 White RAL9006 Grey
Application	High Ceiling Escape route lighting High Ceiling Anti-panic lighting



C.LEDLUX-SPOT-P-HCA / MULTILED-SPOT-P-HCA
(Page No.154)



C.LEDLUX-SPOT-P-HCB / MULTILED-SPOT-P-HCB
(Page No.158)

NÍZKY STROP Aplikácia <4m

LOW CEILING Applications <4m

LEDLUX-SPOT2-A-V / LEDLUX-SPOT2-A-P

escape routes lighting

LED emergency luminaire for escape route lighting in accordance with EN1838
Maximum luminaire spacing : up to 23,5m>1lx

LED núdzové svietidlo pre osvetlenie únikovej cesty v súlade s EN1838
Maximálny rozostup svietidiel: až 23,5m>1lx

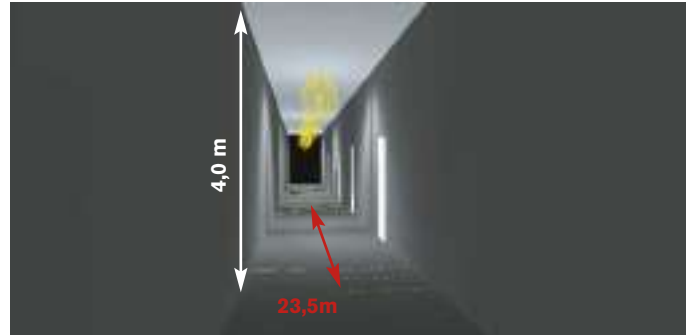
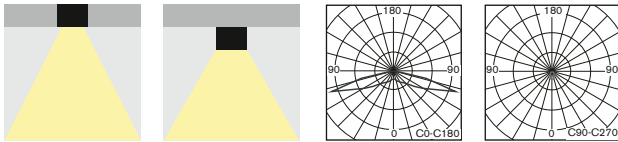

LEDLUX-SPOT2-B-V / LEDLUX-SPOT2-B-P

Anti-panic in open area applications

LED emergency luminaire for anti-panic lighting in accordance with EN1838
Maximum room illumination: up to 126m²>0,5lx

LED núdzové svietidlo pre osvetlenie otvorených priestorov v súlade s EN1838
Maximálna plocha osvetlenia v otvorenom priestore: až 126m²>0,5lx

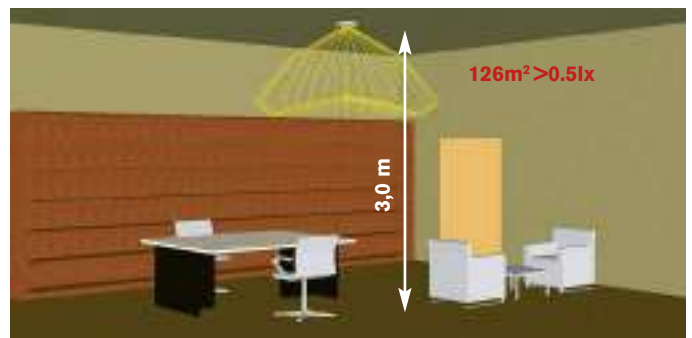
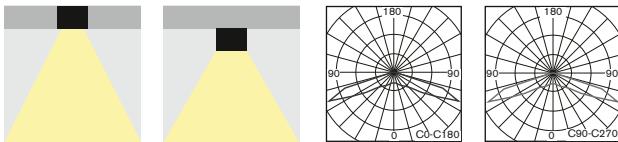

Look up pages No. 328-335 for 1lx Spacing tables
Pozri str. 328-335 pre rozmiestnenie svietidiel na dosiahnutie 1lx

VYSOKÝ STROP Aplikácia >4m

HIGH CEILING Applications >4m

LEDLUX-SPOT2-HCA-P

escape routes lighting for **HIGH CEILING** applications

LED emergency luminaire for escape route lighting in accordance with EN1838
Designed for high ceiling corridor application up to 9m mounting height
Maximum luminaire spacing : up to 28,3m>1lx

LED núdzové svietidlo pre osvetlenie únikovej cesty v súlade s EN1838
Určené pre montáž na strop až do výšky 9m
Maximálny rozostup svietidiel: až 28,3m>1lx

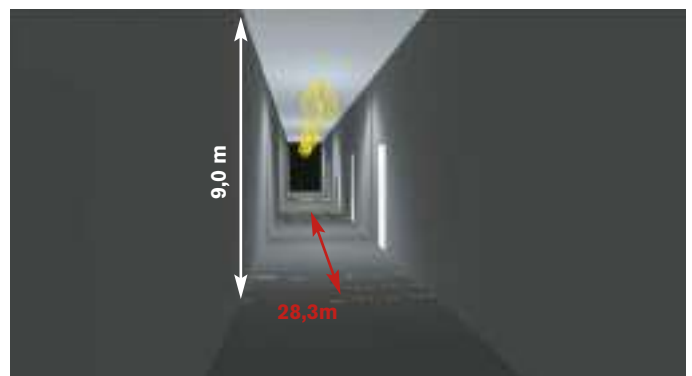
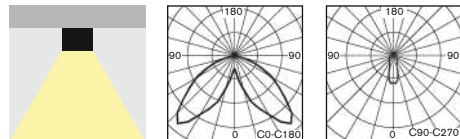

LEDLUX-SPOT2-HCB-P

Anti-panic in **HIGH CEILING** open area applications

LED emergency luminaire for anti-panic lighting in accordance with EN1838
Designed for high ceiling open area application up to 8m mounting height
Maximum room illumination: up to 277m²>0,5lx

LED núdzové svietidlo pre osvetlenie otvorených priestorov v súlade s EN1838
Určené pre montáž na strop až do výšky 8m
Maximálna plocha osvetlenia v otvorenom priestore: až 277m²>0,5lx

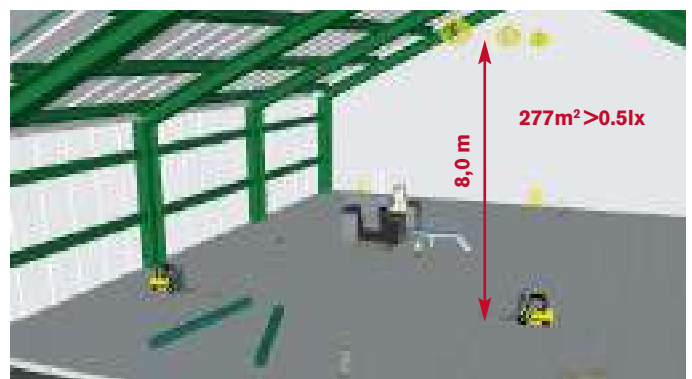
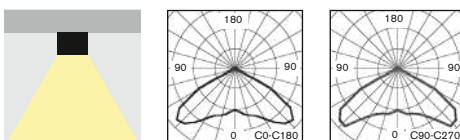

Look up pages No. 210-217 for 1lx Spacing tables
Pozri str.210-217 pre rozmiestnenie svietidiel na dosiahnutie 1lx

RECESSED ESCAPE ROUTE LIGHTING LEDLUX-SPOT2-A-V

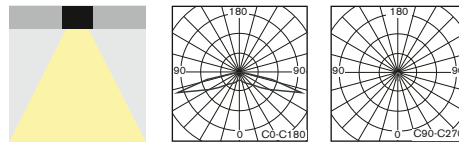

• Small and powerful **recessed LED** non-maintained (NM), maintained (M) or centralised (C) emergency lighting for perfect light distribution **especially** designed for a **corridor applications (escape route illumination to EN1838)**. It is available in all following versions:

- **AUTOTEST** (-AT)
- **DALI**
- **CENTRALTEST** (-ATXL) for **ELMAX LOOK** system (look up also page No.36)
- **CENTRALTEST** (-ATRF) for **ELMAX Wireless** system (look up page No.38)
- **CENTRAL BATTERY** (C.LEDLUX-SPOT2) for **non-addressable CBS** (look up also page No.44)
- **CENTRAL BATTERY** (-ATXP) for system **ELMAX-PATROLUX & Addressable CBS** (look up also pages No.40)
- Conforming to the requirement of EN60598-2-22, EN1838, EN62034
- Design: plastic body in RAL9006 (grey) or RAL9003 (white)
- malé, výkonné LED svietidlo pre **netrvalé (NM), trvalé (M)** alebo **centrálne (C)** núdzové osvetlenie pre zapustenú montáž zaručujúce vysokú hladinu svetelného toku **špeciálne navrhnuté pre osvetlenie chodieb**, aj s funkciami:
 - **AUTOTEST** (-AT)
 - **DALI**
 - **CENTRALTEST** (-ATXL) pre systém ELMAX LOOK (pozri str.36)
 - **bezdrôtový CENTRALTEST** (-ATRF) pre ELMAX-Wireless systém (str.38)
 - **CENTRAL BATTERY** (C.LEDLUX-SPOT2) pre **neadresovateľné CBS** (str.44)
 - **CENTRAL BATTERY** (-ATXP) pre systém **ELMAX-PATROLUX s adresovateľnou CBS** (pozri str. 40)
- spĺňa požiadavky európskej normy EN 60598-2-22, EN1838, EN62034
- konštrukcia: teleso z plastu vo farbe RAL9006 (šedá) alebo RAL9003 (biela)

STANDARD FEATURES

STANDARDNÁ VÝBAVA

- **High efficient HighPower (120lm/W) LONGLIFE LEDs (>100.000h)**
- **NEW Advanced Electronics**
- **LONGLIFE LiFePo4 battery**
- **Special LED lens** for perfect light distribution
- **Installation Mode** (battery protection, for more details look up page No.51+142)
- **Intelligent battery charging** (intermittent charging, look up page No.51+142)
- **DIP Switch** allowing to preset following functions:
 - **INSTALLATION MODE** activation/deactivation (look up page No.51+142)
 - **Maintained mode** activation/deactivation
- Addressable CENTRALTEST communication module (for ATXL, ATRF, ATXP only)
- LEDs indicating presence of power supply and signaling failures & TEST button
- **vysoko účinné HighPower LED (120lm/W) so životnosťou min.100000h**
- **progresívna elektronická jednotka**
- **LONGLIFE LiFePo4 batéria**
- špeciálna LED šošovka pre perfektnú distribúciu svetla
- **Inštalčný mód** (ochrana batérie, pozri aj str.51+142)
- **Inteligentné nabíjanie batérie** ("intermittent" nabíjanie, pozri aj str.51+142)
- **DIP prepínač** umožňujúci prednastavenie funkcií:
 - **Inštalčný mód** aktivácia / deaktivácia (pozri aj str.51+142)
 - trvalé núdzové osvetlenie aktivácia / deaktivácia
- adresovateľný CENTRALTEST komunikačný modul (len pre ATXL, ATRF, ATXP verzie)
- signalizácia LED a TEST tlačítko

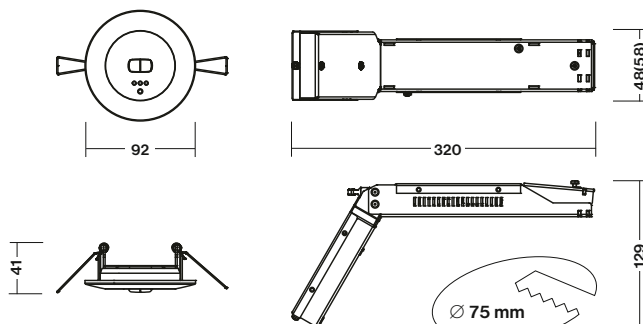
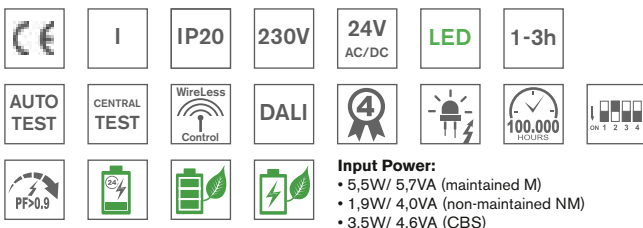

* Dimmensions in the bracket are valid for 3h versions
* rozmery v zátvorke platia pre 3h verzie

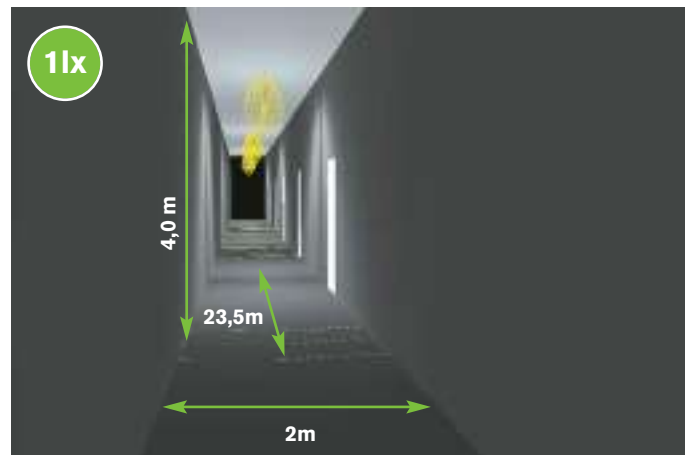



RECESSED ESCAPE ROUTE LIGHTING LEDLUX-SPOT2-A-V

1LX SPACING TABLE / ROZMIESTNENIE PRE 1LX

H (m)	Y1 (m)	Y2 (m)
2,75	8,3	20,1
3,00	8,4	20,9
3,50	7,9	22,5
4,00	7,7	23,5
4,50	7,1	23,1
5,00	6,4	21,9

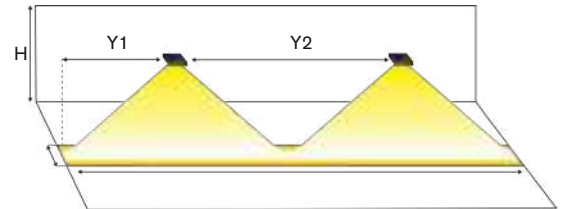

Page No.32

AUTOTEST -AT NM/M

Type	Colour	Light Source	Light Flux / Emergency mode	Battery	Order Code	Weight
MULTILED-SPOT2-A-V-AT.1h	White / biela	HighPower LED	150 lm / 150 lm	LiFePo4 6,4V/1,0Ah	182-B-301-04-00-01	0,6 kg
MULTILED-SPOT2-A-V-AT.1h	Grey / šedá	HighPower LED	150 lm / 150 lm	LiFePo4 6,4V/1,0Ah	182-B-301-04-00-02	0,6 kg
MULTILED-SPOT2-A-V-AT.3h	White / biela	HighPower LED	150 lm / 150 lm	LiFePo4 6,4V/2,0Ah	182-B-309-04-00-01	0,7 kg
MULTILED-SPOT2-A-V-AT.3h	Grey / šedá	HighPower LED	150 lm / 150 lm	LiFePo4 6,4V/2,0Ah	182-B-309-04-00-02	0,7 kg

DALI SELF-CONTAINED

Type	Colour	Light Source	Light Flux / Emergency	Battery	Order Code	Weight
MULTILED-SPOT2-A-V-DALI.1h	White / biela	HighPower LED	150 lm / 150 lm	LiFePo4 6,4V/1,0Ah	182-B-307-04-00-01	0,6 kg
MULTILED-SPOT2-A-V-DALI.1h	Grey / šedá	HighPower LED	150 lm / 150 lm	LiFePo4 6,4V/1,0Ah	182-B-307-04-00-02	0,6 kg
MULTILED-SPOT2-A-V-DALI.3h	White / biela	HighPower LED	150 lm / 150 lm	LiFePo4 6,4V/2,0Ah	182-B-305-04-00-01	0,7 kg
MULTILED-SPOT2-A-V-DALI.3h	Grey / šedá	HighPower LED	150 lm / 150 lm	LiFePo4 6,4V/2,0Ah	182-B-305-04-00-02	0,7 kg

Page No.36

CENTRALTEST -ATXL ELMAX-LOOK

Type	Colour	Light Source	Light Flux / Emergency mode	Battery	Order Code	Weight
MULTILED-SPOT2-A-V-ATXL.1h	White / biela	HighPower LED	150 lm / 150 lm	LiFePo4 6,4V/1,0Ah	182-B-310-04-00-01	0,6 kg
MULTILED-SPOT2-A-V-ATXL.1h	Grey / šedá	HighPower LED	150 lm / 150 lm	LiFePo4 6,4V/1,0Ah	182-B-310-04-00-02	0,6 kg
MULTILED-SPOT2-A-V-ATXL.3h	White / biela	HighPower LED	150 lm / 150 lm	LiFePo4 6,4V/2,0Ah	182-B-311-04-00-01	0,7 kg
MULTILED-SPOT2-A-V-ATXL.3h	Grey / šedá	HighPower LED	150 lm / 150 lm	LiFePo4 6,4V/2,0Ah	182-B-311-04-00-02	0,7 kg

Page No.38

Wireless CENTRALTEST ELMAX-ATRF

Type	Colour	Light Source	Light Flux / Emergency	Battery	Order Code	Weight
MULTILED-SPOT2-A-V-ATRF.1h	White / biela	HighPower LED	150 lm / 150 lm	LiFePo4 6,4V/1,0Ah	182-B-312-04-00-01	0,7 kg
MULTILED-SPOT2-A-V-ATRF.1h	Grey / šedá	HighPower LED	150 lm / 150 lm	LiFePo4 6,4V/1,0Ah	182-B-312-04-00-02	0,7 kg

Page No.44

CENTRAL BATTERY (CBS)

Type	Colour	Version	Light Source	Light Flux	Order Code	Weight
C.LEDLUX-SPOT2-A-V/230V AC/DC	White / biela	CBS NON-ADDRESSABLE	HighPower LED	150 lm	182-B-303-00-00-01	0,5 kg
C.LEDLUX-SPOT2-A-V/230V AC/DC	Grey / šedá	CBS NON-ADDRESSABLE	HighPower LED	150 lm	182-B-303-00-00-02	0,5 kg
C.LEDLUX-SPOT2-A-V/24V AC/DC	White / biela	CBS NON-ADDRESSABLE	HighPower LED	150 lm	182-B-313-00-00-01	0,5 kg
C.LEDLUX-SPOT2-A-V/24V AC/DC	Grey / šedá	CBS NON-ADDRESSABLE	HighPower LED	150 lm	182-B-313-00-00-02	0,5 kg

DALI CENTRAL BATTERY (CBS)

Type	Colour	Version	Light Source	Light Flux	Order Code	Weight
C.LEDLUX-SPOT2-A-V-DALI 230V AC	White / biela	DALI CBS	HighPower LED	150 lm	182-B-333-00-00-01	0,5 kg
C.LEDLUX-SPOT2-A-V-DALI 230V AC	Grey / šedá	DALI CBS	HighPower LED	150 lm	182-B-333-00-00-02	0,5 kg

Page No.40

Addressable CENTRAL BATTERY (CBS) -ATXP ELMAX-PATROLUX

Type	Colour	Version	Light Source	Light Flux	Order Code	Weight
C.LEDLUX-SPOT2-A-V-ATXPR/230V AC/DC	White / biela	ATXP CBS ADDRESSABLE	HighPower LED	150 lm	182-B-314-00-00-01	0,6 kg
C.LEDLUX-SPOT2-A-V-ATXPR/230V AC/DC	Grey / šedá	ATXP CBS ADDRESSABLE	HighPower LED	150 lm	182-B-314-00-00-02	0,6 kg

Look up pages No. 210-217 for 1lx Spacing tables
Pozri str.210-217 pre rozmiestnenie svetidiel na dosiahnutie 1lx

ANTIPANIC LIGHTING LEDLUX-SPOT2-V

Light source	LED 5000K
Installed load	5.5W/5.7VA (maintained M) 1.9W/4.0VA (non-maintained NM) 3.5W/4.6VA (CBS)
Housing colour	RAL9003 White RAL9006 Grey
Application	Escape route lighting
Max luminaire spacing up to	23,5m > 1lx



DIP SWITCH FEATURES No. 2-4

DIP PREPÍNAČ č. 2-4 - FUNKCIE

SELF-CONTAINED BATTERY VERSIONS



**INSTALLATION
MODE
SET UP**



**DEFFAULT SETTING
OFF - ACTIVATED
ON - DEACTIVATED**



**NON-MAINTAINED/
MAINTAINED
MODE (NM/ M)
SET UP**



**DEFFAULT SETTING
ON - MAINTAINED
OFF - NON-MAINTAINED**



**AUTOTEST AT /
CENTRALTEST ATXL
MODE
SET UP**



**DEFFAULT SETTING
OFF - AUTOTEST
ON - CENRALTEST**



**NO-AUTOTEST
MODE
SET UP**



**DEFFAULT SETTING
OFF - AUTOTEST ACTIVE
ON - NO-AUTOTEST**

TO SEE THE CHANGE PUSH EITHER TEST BUTTON OR DISCONNECT THE FIXTURE FROM BOTH THE MAINS 230V AND BATTERY

PO PRESTAVENÍ STLAČTE TEST ALEBO ODPOJTE BATÉRIU A 230V NAPAĽANIE NA AKTIVÁCIU ZMENY

ANTIPANIC LIGHTING LEDLUX-SPOT2-V



Light source	LED 5000K
Installed load	5.5W/5.7VA (maintained M) 1.9W/4.0VA (non-maintained NM)
Housing colour	RAL9003 White RAL9006 Grey
Application	Anti-panic lighting
Max room illumination	up to 126m ² > 0.5lx

RECESSED ANTIPANIC LIGHTING LEDLUX-SPOT2-B-V

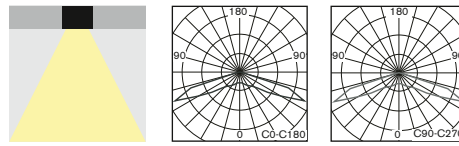

- Small and powerful **recessed LED** non-maintained (NM), maintained (M) or centralised (C) emergency lighting for perfect **wide beam** light distribution **especially designed for a large OPEN AREAS** such as offices, shops, reception desks, lift areas, entrance halls, classrooms, etc.

It is available in all following versions:

- **AUTOTEST** (-AT) or **DALI**
- **CENTRALTEST** (-ATXL) for **ELMAX LOOK** system (look up also page No.36)
- **CENTRALTEST** (-ATRF) for **ELMAX Wireless** system (page No.38)
- **CENTRAL BATTERY** (C.LEDLUX-SPOT2) for **non-addressable CBS** (look up also page No.44)
- **CENTRAL BATTERY** (-ATXP) for system **ELMAX-PATROLUX & Addressable CBS** (look up also page No.40)
- Conforming to the requirement of EN60598-2-22, EN1838, EN62034
- Design: plastic body in RAL9006 (grey) or RAL9003 (white)
- malé, výkonné LED svietidlo pre **netrvalé (NM), trvalé (M)** alebo **centrálné (C)** núdzové osvetlenie pre zapustenú montáž zaručujúce vysokú hladinu svetelného toku špeciálne navrhnuté pre osvetlenie otvorených priestorov (vestibul, kancelária, reštaurácia, školské priestory,...) aj s funkciami:
 - **AUTOTEST** (-AT) alebo **DALI**
 - **CENTRALTEST** (-ATXL) pre systém **ELMAX LOOK** (pozri str.36)
 - **bezdrôtový CENTRALTEST** (-ATRF) pre **ELMAX Wireless** systém (str.38)
 - **CENTRAL BATTERY** (C.LEDLUX-SPOT2) pre **neadresovateľné CBS** (pozri aj str.44)
 - **CENTRAL BATTERY** (-ATXP) pre systém **ELMAX-PATROLUX s adresovateľnou CBS** (pozri str. 40)
- spĺňa požiadavky európskej normy EN 60598-2-22, EN1838, EN62034
- konštrukcia: teleso z plastu vo farbe RAL9006 alebo RAL9003 (biela)

STANDARD FEATURES

STANDARDNÁ VÝBAVA

- **High efficient HighPower (120lm/W) LONGLIFE LEDs (>100.000h)**
- **NEW Advanced Electronics**
- **LONGLIFE LiFePo4 battery**
- **Special LED lens** for perfect light distribution
- **Installation Mode** (battery protection, for more details look up page No.51+142)
- **Intelligent battery charging** (intermittent charging, look up page No.51+142)
- **DIP Switch** allowing to preset following functions:
 - **INSTALLATION MODE** activation/deactivation (look up page No.51+142)
 - **Maintained mode** activation /deactivation
- Addressable CENTRALTEST communication module (for ATXL, ATRF, ATXP only)
- LEDs indicating presence of power supply and signaling failures & TEST button
- **vysoko účinné HighPower LED (120lm/W) so životnosťou min.100000h**
- **progresívna elektronická jednotka**
- **LONGLIFE LiFePo4 batéria**
- špeciálna LED šošovka pre perfektnú distribúciu svetla
- **Inštalčný mód** (ochrana batérie, pozri aj str.51+142)
- **Inteligentné nabíjanie batérie** ("intermittent" nabíjanie, pozri aj str.51+142)
- **DIP prepínač** umožňujúci prednastavenie funkcií:
 - **Inštalčný mód** aktivácia / deaktivácia (pozri aj str.51+142)
 - **trvalé núdzové osvetlenie** aktivácia / deaktivácia
- adresovateľný CENTRALTEST komunikačný modul (len pre ATXL, ATRF, ATXP verzie)
- signalizácia LED a TEST tlačítko

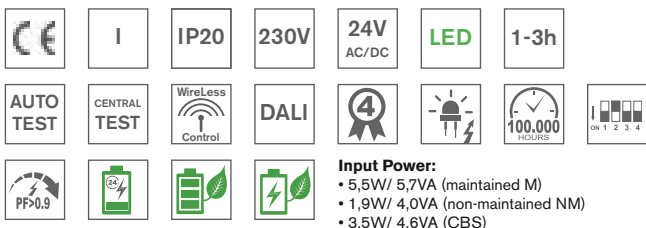

Input Power:
 • 5,5W/ 5,7VA (maintained M)
 • 1,9W/ 4,0VA (non-maintained NM)
 • 3,5W/ 4,6VA (CBS)

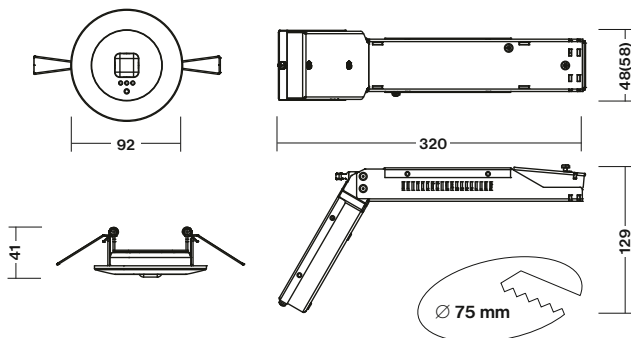

* Dimmensions in the bracket are valid for 3h versions
 * rozmery v zátvorke platia pre 3h verzie

RECESSED ANTIPANIC LIGHTING LEDLUX-SPOT2-B-V



1LX SPACING TABLE / ROZMIESTNENIE PRE 1LX				
H (m)	X1 (m)	X2 (m)	Y1 (m)	Y2 (m)
2,75	3,8	12,6	3,8	12,6
3,00	3,3	12,7	3,3	12,7
3,50	2,5	11,8	2,5	11,8
4,00	1,8	10,1	1,8	10,1

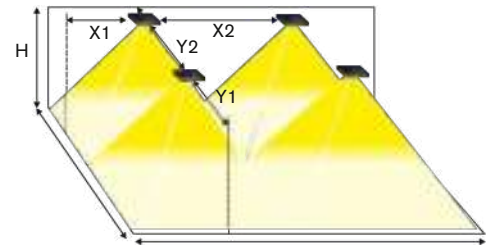

Page No.32

AUTOTEST -AT NM/M

Type	Colour	Light Source	Light Flux / Emergency mode	Battery	Order Code	Weight
MULTILED-SPOT2-B-V-AT.1h	White / biela	HighPower LED	150 lm / 150 lm	LiFePo4 6,4V/1,0Ah	182-B-302-04-00-01	0,6 kg
MULTILED-SPOT2-B-V-AT.1h	Grey / šedá	HighPower LED	150 lm / 150 lm	LiFePo4 6,4V/1,0Ah	182-B-302-04-00-02	0,6 kg
MULTILED-SPOT2-B-V-AT.3h	White / biela	HighPower LED	150 lm / 150 lm	LiFePo4 6,4V/2,0Ah	182-B-315-04-00-01	0,7 kg
MULTILED-SPOT2-B-V-AT.3h	Grey / šedá	HighPower LED	150 lm / 150 lm	LiFePo4 6,4V/2,0Ah	182-B-315-04-00-02	0,7 kg

DALI

Type	Colour	Light Source	Light Flux / Emergency mode	Battery	Order Code	Weight
MULTILED-SPOT2-B-V-DALI.1h	White / biela	HighPower LED	150 lm / 150 lm	LiFePo4 6,4V/1,0Ah	182-B-308-04-00-01	0,6 kg
MULTILED-SPOT2-B-V-DALI.1h	Grey / šedá	HighPower LED	150 lm / 150 lm	LiFePo4 6,4V/1,0Ah	182-B-308-04-00-02	0,6 kg
MULTILED-SPOT2-B-V-DALI.3h	White / biela	HighPower LED	150 lm / 150 lm	LiFePo4 6,4V/2,0Ah	182-B-306-04-00-01	0,7 kg
MULTILED-SPOT2-B-V-DALI.3h	Grey / šedá	HighPower LED	150 lm / 150 lm	LiFePo4 6,4V/2,0Ah	182-B-306-04-00-02	0,7 kg

Page No.36

CENTRALTEST -ATXL ELMAX-LOOK

Type	Colour	Light Source	Light Flux / Emergency mode	Battery	Order Code	Weight
MULTILED-SPOT2-B-V-ATXL.1h	White / biela	HighPower LED	150 lm / 150 lm	LiFePo4 6,4V/1,0Ah	182-B-316-04-00-01	0,6 kg
MULTILED-SPOT2-B-V-ATXL.1h	Grey / šedá	HighPower LED	150 lm / 150 lm	LiFePo4 6,4V/1,0Ah	182-B-316-04-00-02	0,6 kg
MULTILED-SPOT2-B-V-ATXL.3h	White / biela	HighPower LED	150 lm / 150 lm	LiFePo4 6,4V/2,0Ah	182-B-317-04-00-01	0,7 kg
MULTILED-SPOT2-B-V-ATXL.3h	Grey / šedá	HighPower LED	150 lm / 150 lm	LiFePo4 6,4V/2,0Ah	182-B-317-04-00-02	0,7 kg

Page No.38

Wireless CENTRALTEST ELMAX-ATRF

Type	Colour	Light Source	Light Flux / Emergency mode	Battery	Order Code	Weight
MULTILED-SPOT2-B-V-ATRF.1h	White / biela	HighPower LED	150 lm / 150 lm	LiFePo4 6,4V/1,0Ah	182-B-318-04-00-01	0,7 kg
MULTILED-SPOT2-B-V-ATRF.1h	Grey / šedá	HighPower LED	150 lm / 150 lm	LiFePo4 6,4V/1,0Ah	182-B-318-04-00-02	0,7 kg

Page No.44

CENTRAL BATTERY (CBS)

Type	Colour	Version	Light Source	Light Flux	Order Code	Weight
C.LEDLUX-SPOT2-B-V 230V AC/DC	White / biela	CBS NON-ADDRESSABLE	HighPower LED	150 lm	182-B-304-00-00-01	0,5 kg
C.LEDLUX-SPOT2-B-V 230V AC/DC	Grey / šedá	CBS NON-ADDRESSABLE	HighPower LED	150 lm	182-B-304-00-00-02	0,5 kg
C.LEDLUX-SPOT2-B-V 24V AC/DC	White / biela	CBS NON-ADDRESSABLE	HighPower LED	150 lm	182-B-319-00-00-01	0,5 kg
C.LEDLUX-SPOT2-B-V 24V AC/DC	Grey / šedá	CBS NON-ADDRESSABLE	HighPower LED	150 lm	182-B-319-00-00-02	0,5 kg

CENTRAL BATTERY (CBS)

Type	Colour	Version	Light Source	Light Flux	Order Code	Weight
C.LEDLUX-SPOT2-B-V-DALI 230V AC	White / biela	DALI CBS	HighPower LED	150 lm	182-B-334-00-00-01	0,5 kg
C.LEDLUX-SPOT2-B-V-DALI 230V AC	Grey / šedá	DALI CBS	HighPower LED	150 lm	182-B-334-00-00-02	0,5 kg

Page No.40

Addressable CENTRAL BATTERY (CBS) -ATXP ELMAX-PATROLUX

Type	Colour	Version	Light Source	Light Flux	Order Code	Weight
C.LEDLUX-SPOT2-B-V-ATXPR 230V AC/DC	White / biela	ATXP CBS ADDRESSABLE	HighPower LED	150 lm	182-B-320-00-00-01	0,6 kg
C.LEDLUX-SPOT2-B-V-ATXPR 230V AC/DC	Grey / šedá	ATXP CBS ADDRESSABLE	HighPower LED	150 lm	182-B-320-00-00-02	0,6 kg

Look up pages No. 210-217 for 1lx Spacing tables
Pozri str.210-217 pre rozmiestnenie svetidiel na dosiahnutie 1lx

CEILING ESCAPE ROUTE LIGHTING LEDLUX-SPOT2-A-P

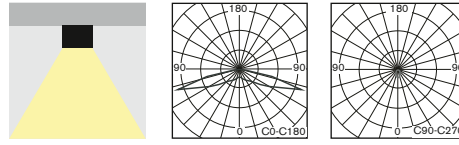

• Small and powerful **surface mounted LED** non-maintained (NM), maintained (M) or centralised (C) emergency lighting for perfect light distribution **especially** designed for a **corridor applications (escape route illumination to EN1838)**. It is available in all following versions:

- **AUTOTEST** (-AT)
- **DALI**,
- **CENTRALTEST** (-ATXL) for **ELMAX LOOK** system (look up also page No.36)
- **CENTRALTEST** (-ATRF) for **ELMAX Wireless** system (look up page No.38)
- **CENTRAL BATTERY** (C.LEDLUX-SPOT2) for **non-addressable CBS** (look up also page No.40)
- **CENTRAL BATTERY** (-ATXP) for system **ELMAX-PATROLUX & Addressable CBS** (look up also pages No.44)
- Conforming to the requirement of EN60598-2-22, EN1838, EN62034
- Design: plastic body in RAL9006 or RAL9003 (white) colour
- malé, výkonné LED svietidlo pre **netrvalé (NM), trvalé (M)** alebo **centrálne (C)** núdzové osvetlenie pre povrchovú montáž zaručujúce **vysokú hladinu svetelného toku špeciálne navrhnuté pre osvetlenie chodieb**, aj s funkciami:
 - **AUTOTEST** (-AT)
 - **DALI**
 - **CENTRALTEST** (-ATXL) pre systém ELMAX LOOK (pozri str.36)
 - **bezdrôtový CENTRALTEST** (-ATRF) pre ELMAX-Wireless systém (str.38)
 - **CENTRAL BATTERY** (C.LEDLUX-SPOT2) pre **neadresovateľné CBS** (str.44)
 - **CENTRAL BATTERY** (-ATXP) pre systém **ELMAX-PATROLUX s adresovateľnou CBS** (pozri str. 40)
- spĺňa požiadavky európskej normy EN 60598-2-22, EN1838, EN62034
- konštrukcia: teleso z plastu vo farbe RAL9006 (šedá) alebo RAL9003 (biela)

STANDARD FEATURES

STANDARDNÁ VÝBAVA

- **High efficient HighPower (120lm/W) LONGLIFE LEDs (>100.000h)**
- **NEW Advanced Electronics**
- **LONGLIFE LiFePo4 battery**
- **Special LED lens** for perfect light distribution
- **Installation Mode** (battery protection, for more details look up page No.51+142)
- **Intelligent battery charging** (intermittent charging, look up page No.51+142)
- **DIP Switch** allowing to preset following functions:
 - **INSTALLATION MODE** activation/deactivation (look up page No.51+142)
 - **Maintained mode** activation/deactivation
- Addressable CENTRALTEST communication module (for ATXL, ATRF, ATXP only)
- LEDs indicating presence of power supply and signaling failures & TEST button
- **vysoko účinné HighPower LED (120lm/W) so životnosťou min.100000h**
- **progressívna elektronická jednotka**
- **LONGLIFE LiFePo4 batéria**
- špeciálna LED šošovka pre perfektnú distribúciu svetla
- **Inštalčný mód** (ochrana batérie, pozri aj str.51+142)
- **Inteligentné nabíjanie batérie** ("intermittent" nabíjanie, pozri aj str.51+142)
- **DIP prepínač** umožňujúci prednastavenie funkcií:
 - **Inštalčný mód** aktivácia / deaktivácia (pozri aj str.51+142)
 - trvalé núdzové osvetlenie aktivácia / deaktivácia
- adresovateľný CENTRALTEST komunikačný modul (len pre ATXL, ATRF, ATXP verzie)
- signalizácia LED a TEST tlačítko

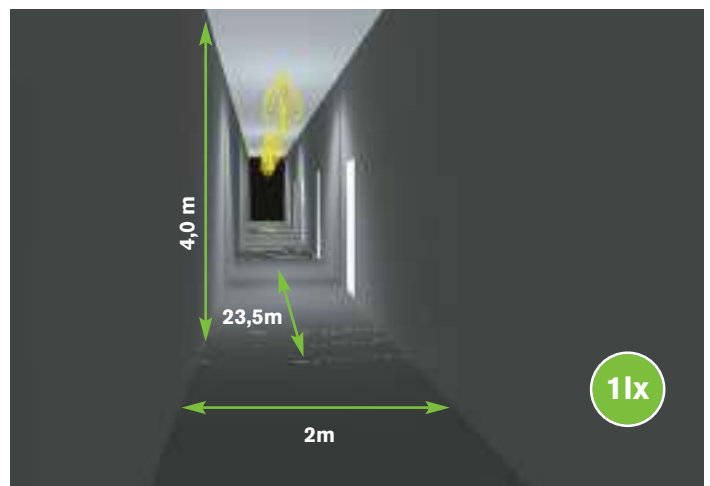
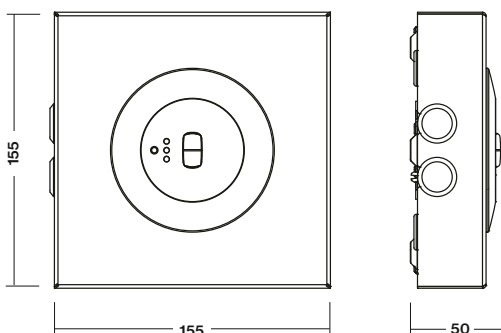
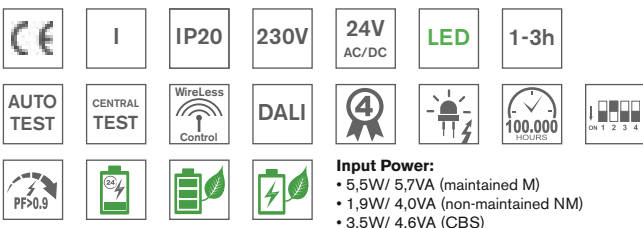

CEILING ESCAPE ROUTE LIGHTING LEDLUX-SPOT2-A-P



1LX SPACING TABLE / ROZMIESTNENIE PRE 1LX		
H (m)	Y1 (m)	Y2 (m)
2,75	8,3	20,1
3,00	8,4	20,9
3,50	7,9	22,5
4,00	7,7	23,5
4,50	7,1	23,1
5,00	6,4	21,9

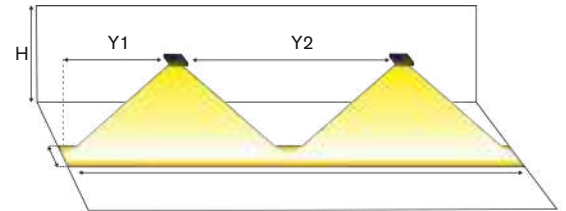

Page No.32

AUTOTEST -AT NM/M

Type	Colour	Light Source	Light Flux / Emergency mode	Battery	Order Code	Weight
MULTILED-SPOT2-A-P-AT.1h	White / biela	HighPower LED	150 lm / 150 lm	LiFePo4 6,4V/1,0Ah	182-B-202-04-00-01	0,7 kg
MULTILED-SPOT2-A-P-AT.1h	Grey / šedá	HighPower LED	150 lm / 150 lm	LiFePo4 6,4V/1,0Ah	182-B-202-04-00-02	0,7 kg
MULTILED-SPOT2-A-P-AT.3h	White / biela	HighPower LED	150 lm / 150 lm	LiFePo4 6,4V/2,0Ah	182-B-206-04-00-01	0,8 kg
MULTILED-SPOT2-A-P-AT.3h	Grey / šedá	HighPower LED	150 lm / 150 lm	LiFePo4 6,4V/2,0Ah	182-B-206-04-00-02	0,8 kg

DALI SELF-CONTAINED

Type	Colour	Light Source	Light Flux / Emergency	Battery	Order Code	Weight
MULTILED-SPOT2-A-P-DALI.1h	White / biela	HighPower LED	150 lm / 150 lm	LiFePo4 6,4V/1,0Ah	182-B-207-04-00-01	0,7 kg
MULTILED-SPOT2-A-P-DALI.1h	Grey / šedá	HighPower LED	150 lm / 150 lm	LiFePo4 6,4V/1,0Ah	182-B-207-04-00-02	0,7 kg
MULTILED-SPOT2-A-P-DALI.3h	White / biela	HighPower LED	150 lm / 150 lm	LiFePo4 6,4V/2,0Ah	182-B-208-04-00-01	0,8 kg
MULTILED-SPOT2-A-P-DALI.3h	Grey / šedá	HighPower LED	150 lm / 150 lm	LiFePo4 6,4V/2,0Ah	182-B-208-04-00-02	0,8 kg

Page No.36

CENTRALTEST -ATXL ELMAX-LOOK

Type	Colour	Light Source	Light Flux / Emergency mode	Battery	Order Code	Weight
MULTILED-SPOT2-A-P-ATXL.1h	White / biela	HighPower LED	150 lm / 150 lm	LiFePo4 6,4V/1,0Ah	182-B-209-04-00-01	0,7 kg
MULTILED-SPOT2-A-P-ATXL.1h	Grey / šedá	HighPower LED	150 lm / 150 lm	LiFePo4 6,4V/1,0Ah	182-B-209-04-00-02	0,7 kg
MULTILED-SPOT2-A-P-ATXL.3h	White / biela	HighPower LED	150 lm / 150 lm	LiFePo4 6,4V/2,0Ah	182-B-210-04-00-01	0,8 kg
MULTILED-SPOT2-A-P-ATXL.3h	Grey / šedá	HighPower LED	150 lm / 150 lm	LiFePo4 6,4V/2,0Ah	182-B-210-04-00-02	0,8 kg

Page No.38

Wireless CENTRALTEST ELMAX-ATRF

Type	Colour	Light Source	Light Flux / Emergency	Battery	Order Code	Weight
MULTILED-SPOT2-A-P-ATRF.1h	White / biela	HighPower LED	150 lm / 150 lm	LiFePo4 6,4V/1,0Ah	182-B-211-04-00-01	0,7 kg
MULTILED-SPOT2-A-P-ATRF.1h	Grey / šedá	HighPower LED	150 lm / 150 lm	LiFePo4 6,4V/1,0Ah	182-B-211-04-00-02	0,7 kg

Page No.44

CENTRAL BATTERY (CBS)

Type	Colour	Version	Light Source	Light Flux	Order Code	Weight
C.LEDLUX-SPOT2-A-P/230V AC/DC	White / biela	CBS NON-ADDRESSABLE	HighPower LED	150 lm	182-B-204-00-00-01	0,6 kg
C.LEDLUX-SPOT2-A-P/230V AC/DC	Grey / šedá	CBS NON-ADDRESSABLE	HighPower LED	150 lm	182-B-204-00-00-02	0,6 kg
C.LEDLUX-SPOT2-A-P/24V AC/DC	White / biela	CBS NON-ADDRESSABLE	HighPower LED	150 lm	182-B-212-00-00-01	0,6 kg
C.LEDLUX-SPOT2-A-P/24V AC/DC	Grey / šedá	CBS NON-ADDRESSABLE	HighPower LED	150 lm	182-B-212-00-00-02	0,6 kg

DALI CENTRAL BATTERY (CBS)

Type	Colour	Version	Light Source	Light Flux	Order Code	Weight
C.LEDLUX-SPOT2-A-P-DALI 230V AC	White / biela	DALI CBS	HighPower LED	150 lm	182-B-238-00-00-01	0,6 kg
C.LEDLUX-SPOT2-A-P-DALI 230V AC	Grey / šedá	DALI CBS	HighPower LED	150 lm	182-B-238-00-00-02	0,6 kg

Page No.40

Addressable CENTRAL BATTERY (CBS) -ATXP ELMAX-PATROLUX

Type	Colour	Version	Light Source	Light Flux	Order Code	Weight
C.LEDLUX-SPOT2-A-P-ATXPR/230V AC/DC	White / biela	ATXP CBS ADDRESSABLE	HighPower LED	150 lm	182-B-213-00-00-01	0,6 kg
C.LEDLUX-SPOT2-A-P-ATXPR/230V AC/DC	Grey / šedá	ATXP CBS ADDRESSABLE	HighPower LED	150 lm	182-B-213-00-00-02	0,6 kg

Look up pages No. 210-217 for 1lx Spacing tables
Pozri str.210-217 pre rozmiestnenie svetidiel na dosiahnutie 1lx

CEILING ESCAPE ROUTE LIGHTING LEDLUX-SPOT2-A-P

Light source	LED 5000K
Installed load	5.5W/5.7VA (maintained M) 1.9W/4.0VA (non-maintained NM) 3.5W/4.6VA (CBS)
Housing colour	RAL9003 White RAL9006 Grey
Application	Escape route lighting
Max luminaire spacing	up to 23,5m > 1lx



CEILING ANTIPANIC LIGHTING LEDLUX-SPOT2-B-P

Light source	LED 5000K
Installed load	5.5W/5.7VA (maintained M) 1.9W/4.0VA (non-maintained NM) 3.5W/4.6VA (CBS)
Housing colour	RAL9003 White RAL9006 Grey
Application	Anti-panic lighting
Max room illumination	up to 126m² > 0.5lx



CEILING ANTIPANIC LIGHTING LEDLUX-SPOT2-B-P

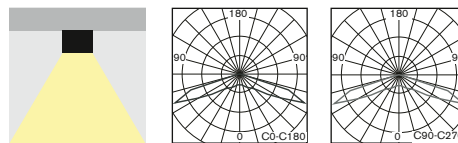

• Small and powerful **surface mounted LED** non-maintained (NM), maintained (M) or centralised (C) emergency lighting for perfect **wide beam** light distribution **especially** designed for a **large OPEN AREAS** such as **offices, shops, reception desks, lift areas, entrance halls, classrooms, etc.**
It is available in all following versions:

- **AUTOTEST** (-AT)
- **DALI**
- **CENTRALTEST** (-ATXL) for **ELMAX LOOK** system (look up also page No.36)
- **CENTRALTEST** (-ATRF) for **ELMAX Wireless** system (look up page No.38)
- **CENTRAL BATTERY** (C.LEDLUX-SPOT2) for **non-addressable CBS** (page 44)
- **CENTRAL BATTERY** (-ATXP) for system **ELMAX-PATROLUX & Addressable CBS** (look up also page No.40)
- Conforming to the requirement of EN60598-2-22, EN1838, EN62034
- Design: plastic body in RAL9006 (grey) or RAL9003 (white) colour
- malé, výkonné LED svetidlo pre **netrvalé (NM), trvalé (M)** alebo **centrálné (C)** núdzové osvetlenie pre povrchovú montáž zaručujúce vysokú hladinu svetelného toku so širokou krivkou svietivosti špeciálne navrhnuté pre osvetlenie rozlohou veľkých otvorených priestorov ako napr. kancelárie, obchody, recepcie, nástupný priestor výťahov, vstupné haly školské triedy a pod., aj s funkciami:
- **AUTOTEST** (-AT)
- **DALI**
- **CENTRALTEST** (-ATXL) pre systém ELMAX LOOK (pozri str.36)
- **bezdrôtový CENTRALTEST** (-ATRF) pre ELMAX-Wireless systém (str.38)
- **CENTRAL BATTERY** (C.LEDLUX-SPOT2) pre **neadresovateľné CBS** (str.44)
- **CENTRAL BATTERY** (-ATXP) pre systém **ELMAX-PATROLUX s adresovateľnou CBS** (pozri aj str. 40)
- spĺňa požiadavky európskej normy EN 60598-2-22, EN1838, EN62034
- konštrukcia: teleso z plastu vo farbe RAL9006 (šedá) alebo RAL9003 (biela)

STANDARD FEATURES

ŠTANDARDNÁ VÝBAVA

- **High efficient HighPower (120lm/W) LONGLIFE LEDs (>100.000h)**
- **NEW Advanced Electronics**
- **LONGLIFE LiFePo4 Battery**
- **Special LED lens** for perfect light distribution
- **Installation Mode** (battery protection, for more details look up page No.51+142)
- **Intelligent battery charging** (intermittent charging, look up page No.51+142)
- **DIP Switch** allowing to preset following functions:
 - **INSTALLATION MODE** activation/deactivation (look up page No.51+142)
 - **Maintained mode** activation/deactivation
- Addressable CENTRALTEST communication module (for ATXL, ATRF, ATXP only)
- LEDs indicating presence of power supply and signaling failures & TEST button
- **vysoko účinné HighPower LED (120lm/W) so životnosťou min.100000h**
- **progresívna elektronická jednotka**
- **LONGLIFE LiFePo4 batéria**
- špeciálna LED šošovka pre perfektnú distribúciu svetla
- **Instalačný mód** (ochrana batérie, pozri aj str.51+142)
- **Inteligentné nabíjanie batérie** ("intermittent" nabíjanie, pozri aj str.51+142)
- **DIP prepínač** umožňujúci prednastavenie funkcií:
 - **Instalačný mód** aktivácia / deaktivácia (pozri aj str.51+142)
 - **trvalé núdzové osvetlenie** aktivácia / deaktivácia
- adresovateľný CENTRALTEST komunikačný modul (len pre ATXL, ATRF, ATXP verzie)
- signalizácia LED a TEST tlačítko



				Input Power:		

• 5,5W/ 5,7VA (maintained M)
 • 1,9W/ 4,0VA (non-maintained NM)
 • 3,5W/ 4,6VA (CBS)

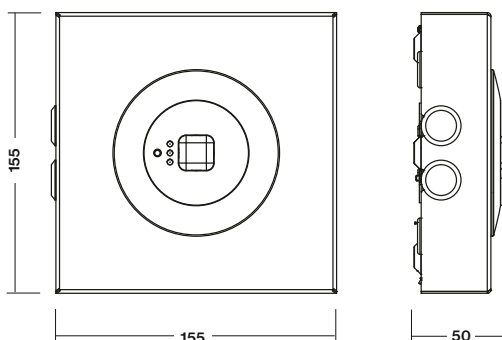

CEILING ANTIPANIC LIGHTING LEDLUX-SPOT2-B-P



1LX SPACING TABLE / ROZMIESTNENIE PRE 1LX					
H (m)	X1 (m)	X2 (m)	Y1 (m)	Y2 (m)	
2,75	3,8	12,6	3,8	12,6	
3,00	3,3	12,7	3,3	12,7	
3,50	2,5	11,8	2,5	11,8	
4,00	1,8	10,1	1,8	10,1	

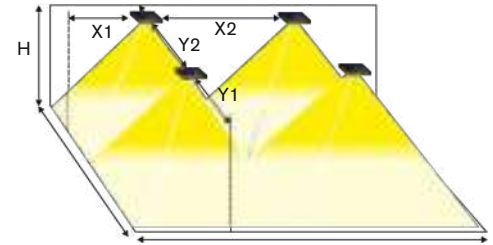

Page No.32

AUTOTEST -AT NM/M

Type	Colour	Light Source	Light Flux / Emergency mode	Battery	Order Code	Weight
MULTILED-SPOT2-B-P-AT.1h	White / biela	HighPower LED	150 lm / 150 lm	LiFePo4 6,4V/1,0Ah	182-B-203-04-00-01	0,7 kg
MULTILED-SPOT2-B-P-AT.1h	Grey / šedá	HighPower LED	150 lm / 150 lm	LiFePo4 6,4V/1,0Ah	182-B-203-04-00-02	0,7 kg
MULTILED-SPOT2-B-P-AT.3h	White / biela	HighPower LED	150 lm / 150 lm	LiFePo4 6,4V/2,0Ah	182-B-214-04-00-01	0,7 kg
MULTILED-SPOT2-B-P-AT.3h	Grey / šedá	HighPower LED	150 lm / 150 lm	LiFePo4 6,4V/2,0Ah	182-B-214-04-00-02	0,7 kg

DALI SELF-CONTAINED

Type	Colour	Light Source	Light Flux / Emergency	Battery	Order Code	Weight
MULTILED-SPOT2-B-P-DALI.1h	White / biela	HighPower LED	150 lm / 150 lm	LiFePo4 6,4V/1,0Ah	182-B-215-04-00-01	0,7 kg
MULTILED-SPOT2-B-P-DALI.1h	Grey / šedá	HighPower LED	150 lm / 150 lm	LiFePo4 6,4V/1,0Ah	182-B-215-04-00-02	0,7 kg
MULTILED-SPOT2-B-P-DALI.3h	White / biela	HighPower LED	150 lm / 150 lm	LiFePo4 6,4V/2,0Ah	182-B-216-04-00-01	0,8 kg
MULTILED-SPOT2-B-P-DALI.3h	Grey / šedá	HighPower LED	150 lm / 150 lm	LiFePo4 6,4V/2,0Ah	182-B-216-04-00-02	0,8 kg

Page No.36

CENTRALTEST -ATXL ELMAX-LOOK

Type	Colour	Light Source	Light Flux / Emergency mode	Battery	Order Code	Weight
MULTILED-SPOT2-B-P-ATXL.1h	White / biela	HighPower LED	150 lm / 150 lm	LiFePo4 6,4V/1,0Ah	182-B-217-04-00-01	0,7 kg
MULTILED-SPOT2-B-P-ATXL.1h	Grey / šedá	HighPower LED	150 lm / 150 lm	LiFePo4 6,4V/1,0Ah	182-B-217-04-00-02	0,7 kg
MULTILED-SPOT2-B-P-ATXL.3h	White / biela	HighPower LED	150 lm / 150 lm	LiFePo4 6,4V/2,0Ah	182-B-218-04-00-01	0,8 kg
MULTILED-SPOT2-B-P-ATXL.3h	Grey / šedá	HighPower LED	150 lm / 150 lm	LiFePo4 6,4V/2,0Ah	182-B-218-04-00-02	0,8 kg

Page No.38

Wireless CENTRALTEST ELMAX-ATRF

Type	Colour	Light Source	Light Flux / Emergency	Battery	Order Code	Weight
MULTILED-SPOT2-B-P-ATRF.1h	White / biela	HighPower LED	150 lm / 150 lm	LiFePo4 6,4V/1,0Ah	182-B-219-04-00-01	0,7 kg
MULTILED-SPOT2-B-P-ATRF.1h	Grey / šedá	HighPower LED	150 lm / 150 lm	LiFePo4 6,4V/1,0Ah	182-B-219-04-00-02	0,7 kg

Page No.44

CENTRAL BATTERY (CBS)

Type	Colour	Version	Light Source	Light Flux	Order Code	Weight
C.LEDLUX-SPOT2-B-P/230V AC/DC	White / biela	CBS NON-ADDRESSABLE	HighPower LED	150 lm	182-B-201-00-00-01	0,6 kg
C.LEDLUX-SPOT2-B-P/230V AC/DC	Grey / šedá	CBS NON-ADDRESSABLE	HighPower LED	150 lm	182-B-201-00-00-02	0,6 kg
C.LEDLUX-SPOT2-B-P/24V AC/DC	White / biela	CBS NON-ADDRESSABLE	HighPower LED	150 lm	182-B-220-00-00-01	0,6 kg
C.LEDLUX-SPOT2-B-P/24V AC/DC	Grey / šedá	CBS NON-ADDRESSABLE	HighPower LED	150 lm	182-B-220-00-00-02	0,6 kg

DALI CENTRAL BATTERY (CBS)

Type	Colour	Version	Light Source	Light Flux	Order Code	Weight
C.LEDLUX-SPOT2-B-P-DALI 230V AC	White / biela	DALI CBS	HighPower LED	150 lm	182-B-239-00-00-01	0,6 kg
C.LEDLUX-SPOT2-B-P-DALI 230V AC	Grey / šedá	DALI CBS	HighPower LED	150 lm	182-B-239-00-00-02	0,6 kg

Page No.40

Addressable CENTRAL BATTERY (CBS) -ATXP ELMAX-PATROLUX

Type	Colour	Version	Light Source	Light Flux	Order Code	Weight
C.LEDLUX-SPOT2-B-P-ATXPR/230V AC/DC	White / biela	ATXP CBS ADDRESSABLE	HighPower LED	150 lm	182-B-221-00-00-01	0,6 kg
C.LEDLUX-SPOT2-B-P-ATXPR/230V AC/DC	Grey / šedá	ATXP CBS ADDRESSABLE	HighPower LED	150 lm	182-B-221-00-00-02	0,6 kg

Look up pages No. 210-217 for 1lx Spacing tables
Pozri str.210-217 pre rozmiestnenie svetidiel na dosiahnutie 1lx

Product
Assortment

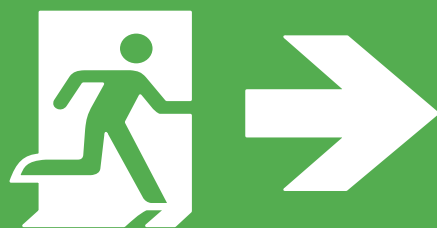

EMERGENCY LIGHTING

NÚDZOVÉ SVIETIDLÁ

PREMIUM Line (Page No: 152-169)
ANTIPANIC **HIGH** Ceiling
ESCAPE ROUTE **HIGH** Ceiling

HIGH CEILING EMERGENCY LIGHTING

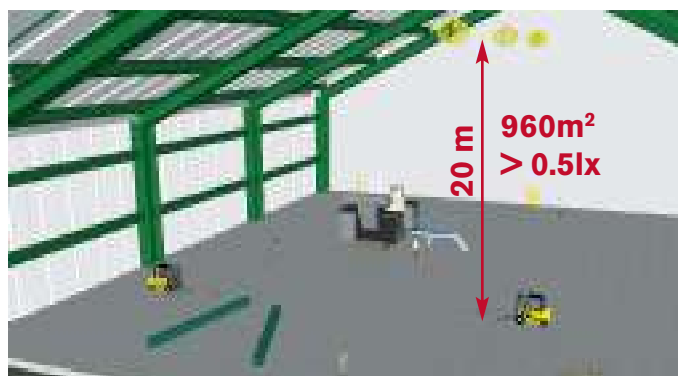
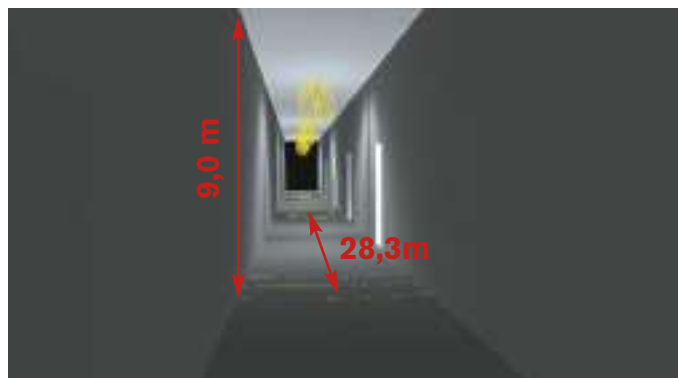
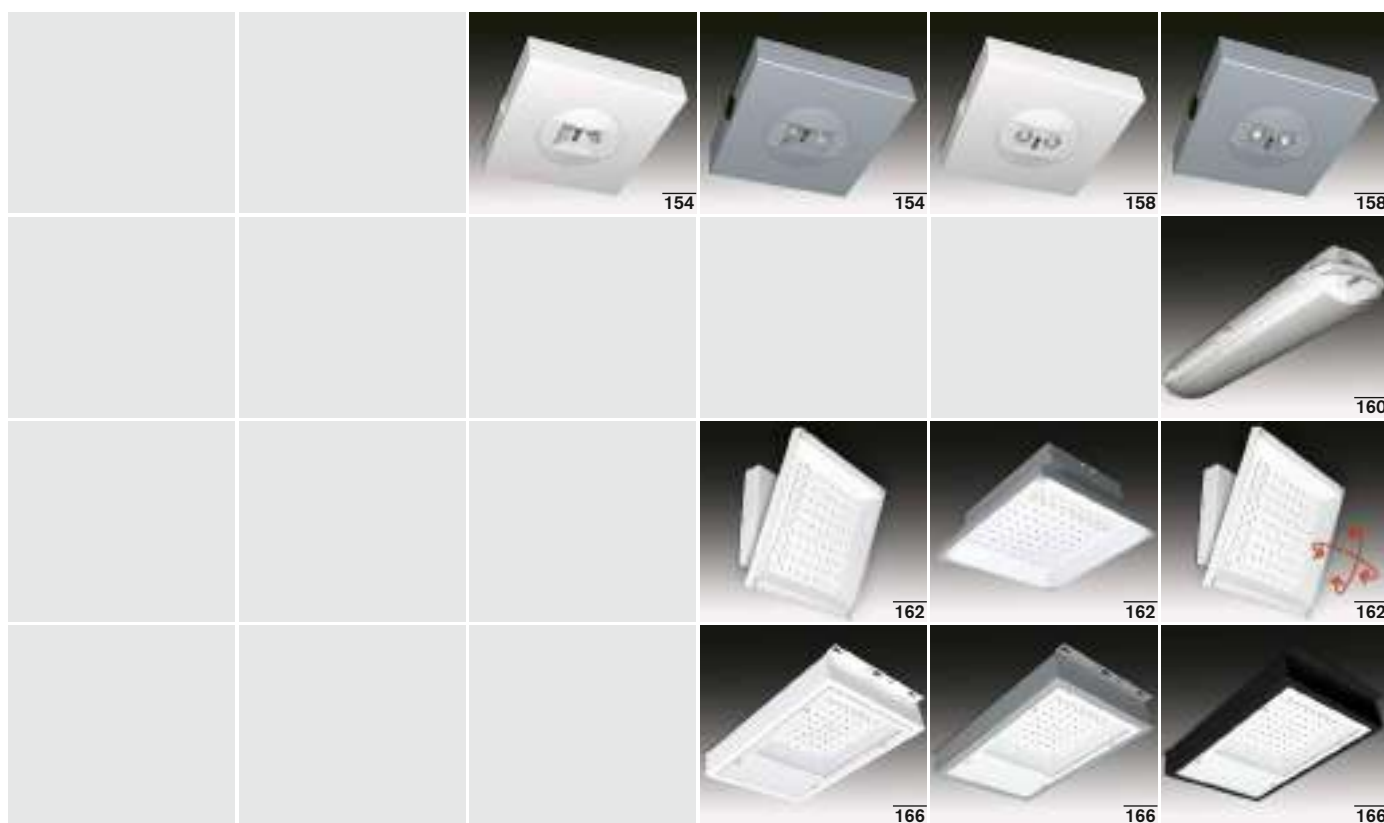

Look up pages No. 210-217 for 1lx Spacing tables
Pozri str.210-217 pre rozmiestnenie svietidiel na dosiahnutie 1lx

HIGH CEILING application LED Fixtures are equipped with all efficient and highpower LEDs, sophisticated optics and powerful battery. Thanks to all the high light output, maximum efficiency and optimal light distribution result in the need for a low number of luminaires for high ceiling application to comply relevant EN standards and possibility of an installation height up to 20m. Thanks to the design the installation and maintenance is quick and simple.

Typová rada **HIGH CEILING** je určená pre núdzové svetlenie priestorov s vysokou výškou stropu až do 20m. Moderný a nenápadný design vychádzajúci z kvalitných materiálov predurčuje svietidlá pre núdzové osvetlenie v súlade s relevantnými normami plne nezávislým na hlavnom osvetlení. Svietidlá sú vybavené vyváženou kombináciou vysokoefektívnych a výkonných LED, špeciálnej optiky a výkonnej batérie, čo zaručuje vysoký svetelný tok, maximálnu účinnosť a optimálnu distribúciu svetla. Vďaka tomu je potrebný malý počet núdzových svietidiel pre splnenie požiadaviek relevantných noriem. Inštalácia a údržba svietidiel je rýchla a jednoduchá.

HIGH CEILING ESCAPE ROUTE LIGHTING LEDLUX-SPOT2-HCA

**FOR HIGH CEILING >4m
PRE VYSOKÉ STROPY >4m**

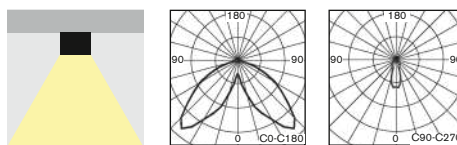

• POWERFUL surface mounted escape-route LED fixture available for all non-maintained (NM), maintained (M) or centralised (C) emergency lighting especially designed for **HIGH CEILING ESCAPE ROUTE** illumination applications in accordance with EN1838

It is available in all following versions:

- **AUTOTEST** (-AT)
- **DALI**
- **CENTRALTEST** (-ATXL) for **ELMAX LOOK** system (look up also page No.36)
- **CENTRAL BATTERY** (C.LEDLUX-SPOT2) for **non-addressable CBS** (No.44)
- **CENTRAL BATTERY** (-ATXP) for system **ELMAX-PATROLUX & Addressable CBS** (look up also page No.40)
- Conforming to the requirement of EN60598-2-22, EN1838, EN62034
- Design: metal sheet body with PE powder coat finish RAL9006 (grey) or RAL9003

• Výkonné LED svietidlá pre **netrvalé** (NM), **trvalé** (M) alebo **centrálne** (C) núdzové osvetlenie pre povrchovú montáž **špeciálne navrhnuté pre aplikácie v koridoroch vo VÝŠKACH** ako napr. sklady, komunikačné tunely,... aj s funkciami:

- **AUTOTEST** (-AT)
- **DALI**
- **CENTRALTEST** (-ATXL) pre systém ELMAX LOOK (pozri str.36)
- **CENTRAL BATTERY** (C.LEDLUX-SPOT2) pre **neadresovateľné CBS** (str.44)
- **CENTRAL BATTERY** (-ATXP) pre systém **ELMAX-PATROLUX s adresovateľnou CBS** (pozri str. 40)
- spĺňa požiadavky európskej normy EN 60598-2-22, EN1838, EN62034
- konštrukcia: teleso z plechu vo farbe RAL9006 (šedá) alebo RAL9003 (biela)

STANDARD FEATURES

ŠTANDARDNÁ VÝBAVA

- **High efficient HighPower (120lm/W) LONGLIFE LEDs (>100.000h)**
- **NEW Advanced Electronics**
- **LONGLIFE LIFEPO4 battery**
- **Special LED lens** for perfect light distribution
- **Installation Mode** (battery protection, for more details look up page No.51)
- **Intelligent battery charging** (intermittent charging, look up page No.51)
- **DIP Switch** allowing to preset following functions:
 - **INSTALLATION MODE** activation/deactivation (look up page No.51)
 - **Maintained mode** activation/deactivation
- Addressable CENTRALTEST communication module (for ATXL, ATRF, ATXP only)
- LEDs indicating presence of power supply and signaling failures & TEST button
- **vysoko účinné HighPower LED (120lm/W) so životnosťou min.100000h**
- **progressívna elektronická jednotka**
- **LONGLIFE LIFEPO4 batéria**
- špeciálna LED šošovka pre perfektnú distribúciu svetla
- **Inštaláčny mód** (ochrana batérie, pozri aj str.51)
- **Inteligentné nabíjanie batérie** ("intermittent" nabíjanie, pozri aj str.51)
- **DIP prepínač** umožňujúci prednastavenie funkcií:
 - **Instalačný mód** aktivácia / deaktivácia (pozri aj str.51)
 - trvalé núdzové osvetlenie aktivácia / deaktivácia
- adresovateľný CENTRALTEST komunikačný modul (len pre ATXL, ATRF, ATXP verzie)
- signalizácia LED a TEST tlačítko

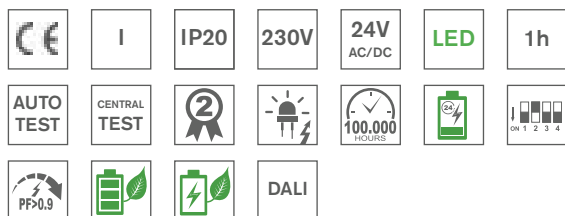

Input Power:

- 7,1W/ 7,3VA (maintained M)
- 2,8W/ 4,3VA (non-maintained NM)
- 4,6W/ 5,2VA (CBS)

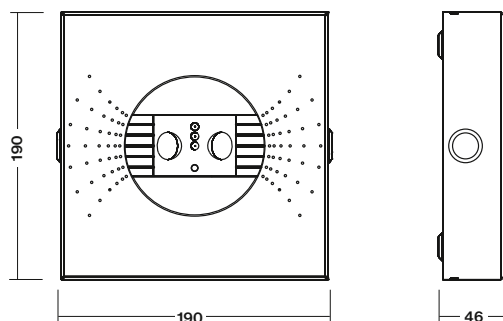

HIGH CEILING ESCAPE ROUTE LIGHTING LEDLUX-SPOT2-HCA



Light source	LED 5000K
LED Light output	410lm
Housing colour	RAL9003 White RAL9006 Grey
Application	High Ceiling Escape route lighting
Max luminaire spacing	up to 28,3m > 1lx

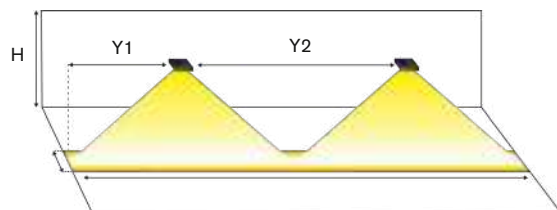

1LX SPACING TABLE / ROZMIESTNENIE PRE 1LX

H (m)	Y1 (m)	Y2 (m)
4,00	8,0	18,9
5,00	8,9	21,4
6,00	9,7	23,5
7,00	10,3	25,4
8,00	10,8	26,9
9,00	11,2	28,3

Page No.32

AUTOTEST -AT NM/M

Type	Colour	Light Source	Light Flux / Emergency mode	Battery	Order Code	Weight
MULTILED-SPOT2-HCA-P-AT.1h	White / biela	2xHighPower LED	410 lm / 410 lm	LiFePo4 6,4V/2,0Ah	182-B-222-04-00-01	1,1 kg
MULTILED-SPOT2-HCA-P-AT.1h	Grey / šedá	2xHighPower LED	410 lm / 410 lm	LiFePo4 6,4V/2,0Ah	182-B-222-04-00-02	1,1 kg

DALI SELF-CONTAINED

Type	Colour	Light Source	Light Flux / Emergency mode	Battery	Order Code	Weight
MULTILED-SPOT2-HCA-P-DALI.1h	White / biela	2xHighPower LED	410 lm / 410 lm	LiFePo4 6,4V/2,0Ah	182-B-240-04-00-01	1,1 kg
MULTILED-SPOT2-HCA-P-DALI.1h	Grey / šedá	2xHighPower LED	410 lm / 410 lm	LiFePo4 6,4V/2,0Ah	182-B-240-04-00-02	1,1 kg

Page No.36

CENTRALTEST -ATXL ELMAX-LOOK

Type	Colour	Light Source	Light Flux / Emergency mode	Battery	Order Code	Weight
MULTILED-SPOT2-HCA-P-ATXL.1h	White / biela	2xHighPower LED	410 lm / 410 lm	LiFePo4 6,4V/2,0Ah	182-B-241-04-00-01	1,2 kg
MULTILED-SPOT2-HCA-P-ATXL.1h	Grey / šedá	2xHighPower LED	410 lm / 410 lm	LiFePo4 6,4V/2,0Ah	182-B-241-04-00-02	1,2 kg

Page No.44

CENTRAL BATTERY (CBS)

Type	Colour	Version	Light Source	Light Flux	Order Code	Weight
C.LEDLUX-SPOT2-HCA-P 230V AC/DC	White / biela	CBS NON-ADDRESSABLE	2xHighPower LEDs	410 lm	182-B-224-00-00-01	0,8 kg
C.LEDLUX-SPOT2-HCA-P 230V AC/DC	Grey / šedá	CBS NON-ADDRESSABLE	2xHighPower LEDs	410 lm	182-B-224-00-00-02	0,8 kg
C.LEDLUX-SPOT2-HCA-P 24V AC/DC	White / biela	CBS NON-ADDRESSABLE	2xHighPower LEDs	410 lm	182-B-225-00-00-01	0,8 kg
C.LEDLUX-SPOT2-HCA-P 24V AC/DC	Grey / šedá	CBS NON-ADDRESSABLE	2xHighPower LEDs	410 lm	182-B-225-00-00-02	0,8 kg

DALI CENTRAL BATTERY (CBS)

Type	Colour	Version	Light Source	Light Flux	Order Code	Weight
C.LEDLUX-SPOT2-HCA-P-DALI 230V AC	White / biela	DALI CBS	2xHighPower LEDs	410 lm	182-B-242-00-00-01	0,8 kg
C.LEDLUX-SPOT2-HCA-P-DALI 230V AC	Grey / šedá	DALI CBS	2xHighPower LEDs	410 lm	182-B-242-00-00-02	0,8 kg

Page No.40

Addressable CENTRAL BATTERY (CBS) -ATXP ELMAX-PATROLUX

Type	Colour	Version	Light Source	Light Flux	Order Code	Weight
C.LEDLUX-SPOT2-HCA-P-ATXPR 230V AC/DC	White / biela	ATXP CBS ADDRESSABLE	2xHighPower LED	410 lm	182-B-226-00-00-01	0,9 kg
C.LEDLUX-SPOT2-HCA-P-ATXPR 230V AC/DC	Grey / šedá	ATXP CBS ADDRESSABLE	2xHighPower LED	410 lm	182-B-226-00-00-02	0,9 kg

Look up pages No. 210-217 for 1lx Spacing tables
Pozri str.210-217 pre rozmiestnenie svetidiel na dosiahnutie 1lx



HIGH CEILING ESCAPE ROUTE LIGHTING
LEDLUX-SPOT2-HCA

HIGH CEILING ANTIPANIC LIGHTING
LEDLUX-SPOT2-HCB



HIGH CEILING ANTIPANIC LIGHTING LEDLUX-SPOT2-HCB

**FOR HIGH CEILING >4m
PRE VYSOKÉ STROPY >4m**



HIGH CEILING >4m



HIGH CEILING >4m

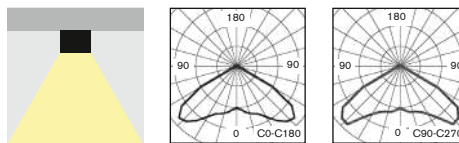

• POWERFULL surface mounted anti-panic LED fixture available for all non-maintained (NM), maintained (M) or centralised (C) emergency lighting especially designed for **HIGH CEILING OPEN AREA** applications in accordance with EN1838
It is available in all following versions:

- **AUTOTEST** (-AT)
- **DALI**
- **CENTRALTEST** (-ATXL) for **ELMAX LOOK** system (look up also page No.36)
- **CENTRAL BATTERY** (C.LEDLUX-SPOT2) for **non-addressable CBS** (look up also page No.44)
- **CENTRAL BATTERY** (-ATXP) for system **ELMAX-PATROLUX & Addressable CBS** (look up also page No.40)
- Conforming to the requirement of EN60598-2-22, EN1838, EN62034
- Design: metal sheet body with PE powder coat finish RAL9006 (grey) or RAL9003 (white)
- výkonné anti-panic LED svietidlá pre **netrvalé (NM), trvalé (M)** alebo **centrálne (C)** núdzové osvetlenie pre povrchovú montáž **špeciálne navrhnuté pre aplikácie VO VEĽKÝCH VÝŠKACH** ako napr. výrobné haly, športové haly, sklady,... aj s funkciami:
 - **AUTOTEST** (-AT)
 - **DALI**
 - **CENTRALTEST** (-ATXL) pre systém ELMAX LOOK (pozri str.36)
 - **CENTRAL BATTERY** (C.LEDLUX-SPOT2) pre **neadresovateľné CBS** (str.44)
 - **CENTRAL BATTERY** (-ATXP) pre systém **ELMAX-PATROLUX s adresovateľnou CBS** (pozri str. 40)
- spĺňa požiadavky európskej normy EN 60598-2-22, EN1838, EN62034
- konštrukcia: teleso z plechu vo farbe RAL9006 (šedá) alebo RAL9003 (biela)

STANDARD FEATURES

STANDARDNÁ VÝBAVA

- **High efficient HighPower (120lm/W) LONGLIFE LEDs (>100.000h)**
- **NEW Advanced Electronics**
- **LONGLIFE LIFEPO4 battery**
- **Special LED lens** for perfect light distribution
- **Installation Mode** (battery protection, for more details look up page No.51)
- **Intelligent battery charging** (intermittent charging, look up page No.51)
- **DIP Switch** allowing to preset following functions:
 - **INSTALLATION MODE** activation/deactivation (look up page No.51)
 - **Maintained mode** activation/deactivation
- Addressable CENTRALTEST communication module (for ATXL, ATRF, ATXP only)
- LEDs indicating presence of power supply and signaling failures & TEST button
- **vysoko účinné HighPower LED (120lm/W) so životnosťou min.100000h**
- **progressívna elektronická jednotka**
- **LONGLIFE LIFEPO4 batéria**
- špeciálna LED šošovka pre perfektnú distribúciu svetla
- **Inštaláčny mód** (ochrana batérie, pozri aj str.51)
- **Inteligentné nabíjanie batérie** ("intermittent" nabíjanie, pozri aj str.51)
- **DIP prepínač** umožňujúci prednastavenie funkcií:
 - **Instalačný mód** aktivácia / deaktivácia (pozri aj str.51)
 - trvalé núdzové osvetlenie aktivácia / deaktivácia
- adresovateľný CENTRALTEST komunikačný modul (len pre ATXL, ATRF, ATXP verzie)
- signalizácia LED a TEST tlačítko

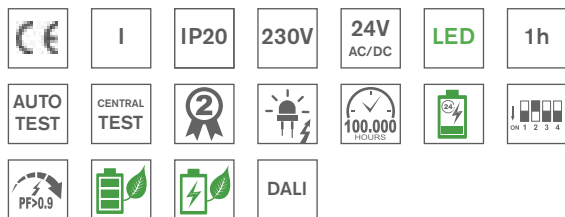

Input Power:

- 7,1W/ 7,3VA (maintained M)
- 2,8W/ 4,3VA (non-maintained NM)
- 4,6W/ 5,2VA (CBS)

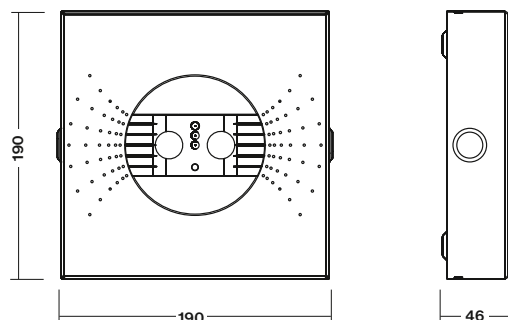

HIGH CEILING ANTIPANIC LIGHTING LEDLUX-SPOT2-HCB

Light source	LED 5000K
LED Light output	410lm
Housing colour	RAL9003 White RAL9006 Grey
Application	High Ceiling Anti-panic lighting
Max room illumination	up to 277m² > 0.5lx

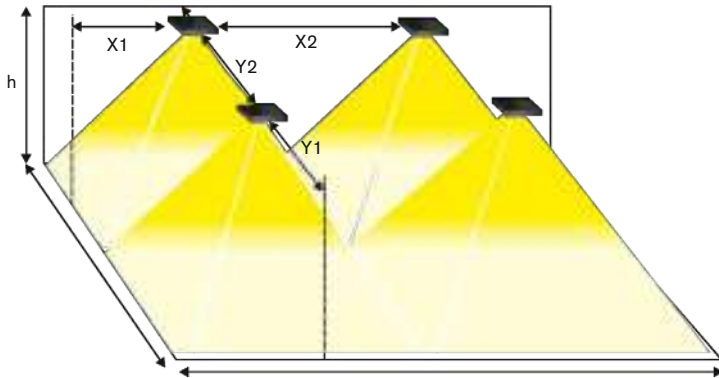

1LX SPACING TABLE / ROZMIESTNENIE PRE 1LX				
h (m)	X1 (m)	X2 (m)	Y1 (m)	Y2 (m)
4,00	6,0	13,9	6,0	13,9
5,00	6,5	15,9	6,5	15,9
6,00	6,7	17,5	6,7	17,5
7,00	6,4	18,5	6,4	18,5
7,50	4,5	18,7	4,5	18,7
8,00	2,7	18,8	2,7	18,8

Page No.32

AUTOTEST -AT NM/M

Type	Colour	Light Source	Light Flux / Emergency mode	Battery	Order Code	Weight
MULTILED-SPOT2-HCB-P-AT.1h	White / biela	2xHighPower LED	410 lm / 410 lm	LiFePo4 6,4V/2,0Ah	182-B-227-04-00-01	1,1 kg
MULTILED-SPOT2-HCB-P-AT.1h	Grey / šedá	2xHighPower LED	410 lm / 410 lm	LiFePo4 6,4V/2,0Ah	182-B-227-04-00-02	1,1 kg

DALI SELF-CONTAINED

Type	Colour	Light Source	Light Flux / Emergency mode	Battery	Order Code	Weight
MULTILED-SPOT2-HCB-P-DALI.1h	White / biela	2xHighPower LED	410 lm / 410 lm	LiFePo4 6,4V/2,0Ah	182-B-243-04-00-01	1,1 kg
MULTILED-SPOT2-HCB-P-DALI.1h	Grey / šedá	2xHighPower LED	410 lm / 410 lm	LiFePo4 6,4V/2,0Ah	182-B-243-04-00-02	1,1 kg

Page No.36

CENTRALTEST -ATXL ELMAX-LOOK

Type	Colour	Light Source	Light Flux / Emergency mode	Battery	Order Code	Weight
MULTILED-SPOT2-HCB-P-ATXL.1h	White / biela	2xHighPower LED	410 lm / 410 lm	LiFePo4 6,4V/2,0Ah	182-B-244-04-00-01	1,2 kg
MULTILED-SPOT2-HCB-P-ATXL.1h	Grey / šedá	2xHighPower LED	410 lm / 410 lm	LiFePo4 6,4V/2,0Ah	182-B-244-04-00-02	1,2 kg

Page No.44

CENTRAL BATTERY (CBS)

Type	Colour	Version	Light Source	Light Flux	Order Code	Weight
C.LEDLUX-SPOT2-HCB-P/230V AC/DC	White / biela	CBS NON-ADDRESSABLE	2xHighPower LEDs	410 lm	182-B-229-00-00-01	0,8 kg
C.LEDLUX-SPOT2-HCB-P/230V AC/DC	Grey / šedá	CBS NON-ADDRESSABLE	2xHighPower LEDs	410 lm	182-B-229-00-00-02	0,8 kg
C.LEDLUX-SPOT2-HCB-P/24V AC/DC	White / biela	CBS NON-ADDRESSABLE	2xHighPower LEDs	410 lm	182-B-230-00-00-01	0,8 kg
C.LEDLUX-SPOT2-HCB-P/24V AC/DC	Grey / šedá	CBS NON-ADDRESSABLE	2xHighPower LEDs	410 lm	182-B-230-00-00-02	0,8 kg

DALI CENTRAL BATTERY (CBS)

Type	Colour	Version	Light Source	Light Flux	Order Code	Weight
C.LEDLUX-SPOT2-HCB-P-DALI 230V AC	White / biela	CBS NON-ADDRESSABLE	2xHighPower LEDs	410 lm	182-B-245-00-00-01	0,8 kg
C.LEDLUX-SPOT2-HCB-P-DALI 230V AC	Grey / šedá	CBS NON-ADDRESSABLE	2xHighPower LEDs	410 lm	182-B-245-00-00-02	0,8 kg

Page No.40

Addressable CENTRAL BATTERY (CBS) -ATXP ELMAX-PATROLUX

Type	Colour	Version	Light Source	Light Flux	Order Code	Weight
C.LEDLUX-SPOT2-HCB-P-ATXPR/230V AC/DC	White / biela	ATXP CBS ADDRESSABLE	2xHighPower LED	410 lm	182-B-231-00-00-01	0,9 kg
C.LEDLUX-SPOT2-HCB-P-ATXPR/230V AC/DC	Grey / šedá	ATXP CBS ADDRESSABLE	2xHighPower LED	410 lm	182-B-231-00-00-02	0,9 kg

Look up pages No. 210-217 for 1lx Spacing tables
Pozri str.210-217 pre rozmiestnenie svetidiel na dosiahnutie 1lx



HIGH CEILING >4m

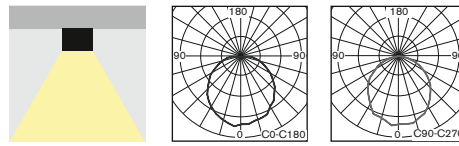

• **POWERFULL** ceiling mounted LED fixture available for all non-maintained (NM), maintained (M) or centralised (C) emergency lighting especially designed **for HIGH CEILING applications**

It is available in all following versions:

- **AUTOTEST** (-AT)
- **DALI**
- **CENTRALTEST** (-ATXL) for ELMAX LOOK system (look up also page No.36)
- **CENTRAL BATTERY** (C.PERUN2) for **non-addressable CBS** (look up also page No.44)
- **CENTRAL BATTERY** (-ATXP) for system **ELMAX-PATROLUX & Addressable CBS** (look up also page No.40)
- Conforming to the requirement of EN60598-2-22, EN1838, EN62034
- Design:
 - impact resistant polycarbonate (PC)

• **NOVÝ typ** výkonného LED svietidla pre **netrvalé (NM), trvalé (M)** alebo **centrálne (C)** núdzové osvetlenie pre povrchovú montáž **špeciálne NAVRHNÉ PRE APLIKÁCIE VO VEĽKÝCH VÝŠKACH** ako napr. výrobné haly, športové haly, sklady,...všade tam, kde je potrebná vysoký výkon v núdzovom režime, aj s funkciami:

- **AUTOTEST** (-AT)
- **DALI**
- **CENTRALTEST** (-ATXL) pre systém ELMAX LOOK (pozri str.36)
- **CENTRAL BATTERY** (C.PERUN2) pre **neadresovateľné CBS** (pozri str.44)
- **CENTRAL BATTERY** (-ATXP) pre systém **ELMAX-PATROLUX s adresovateľnou CBS** (pozri aj str.40)

• spĺňa požiadavky európskej normy EN 60598-2-22, EN1838, EN62034

• konštrukcia:

- teleso a svetelno-činný kryt z nerozbitného polykarbonátu

STANDARD FEATURES

ŠTANDARDNÁ VÝBAVA

- **High efficient MidPower (150lm/W) LONGLIFE LEDs (>100.000h) 5000K**
- **NEW Advanced Electronics**
- **LONGLIFE LIFEPO4 battery**
- **Installation Mode** (battery protection, for more details look up page No.51)
- **Intelligent battery charging** (intermittent charging, look up page No.51)
- **Jumper** allowing to preset following functions:
 - **INSTALLATION MODE** activation/deactivation (look up page No.51)
 - **Maintained mode** activation/deactivation
- Addressable CENTRALTEST communication module (for ATXL, ATRF, ATXP only)
- LEDs indicating presence of power supply and signaling failures & TEST button
- **vysoko účinné MidPower LED (150lm/W) so životnosťou min.100000h (5000K)**
- **progresívna elektronická jednotka**
- **LONGLIFE LIFEPO4 batéria**
- **Inštaláčny mód** (ochrana batérie, pozri aj str.51)
- **Inteligentné nabíjanie batérie** ("intermittent" nabíjanie, pozri aj str.51)
- **Jumper** umožňujúci prednastavenie funkcií:
 - **Instalačný mód** aktivácia / deaktivácia (pozri aj str.51)
 - trvalé núdzové osvetlenie aktivácia / deaktivácia
- adresovateľný CENTRALTEST komunikačný modul (len pre ATXL, ATRF, ATXP verzie)
- signalizácia LED a TEST tlačítko

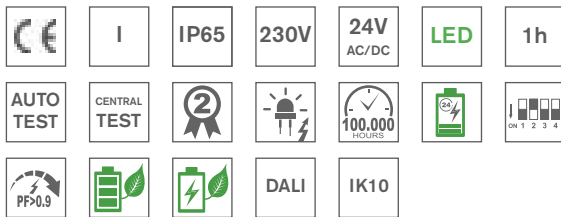

Input Power:

- 17W/ 19VA (maintained M)
- 4,0W/ 5,0VA (non-maintained NM)
- 33W/ 36VA (CBS)

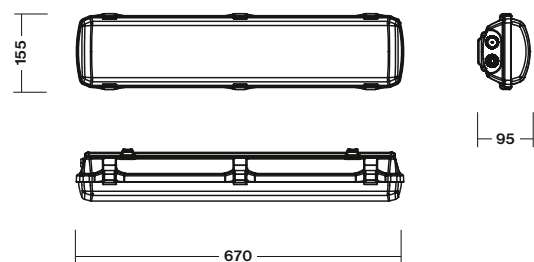

Light source	LED 5000K
LED Light output	1650lm / 3900lm
Housing material	Polycarbonate
Housing material	Polycarbonate
Application	High Ceiling Anti-panic lighting
Max room illumination (CBS C.PERUN2)	up to 1380 m² >0.5lx

**FOR HIGH CEILING >4m
PRE VYSOKÉ STROPY >4m**

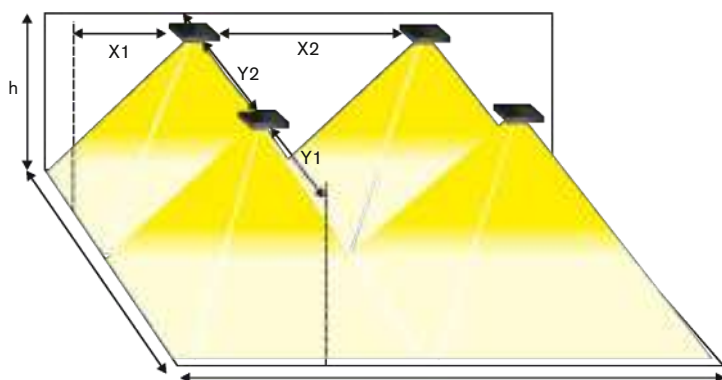

PERUN2-AT 1h (1650lm) 1LX SPACING TABLE					C.PERUN2 (3900lm) 1LX SPACING TABLE				
H (m)	X1 (m)	X2 (m)	Y1 (m)	Y2 (m)	H (m)	X1 (m)	X2 (m)	Y1 (m)	Y2 (m)
4,0	8,0	18,6	7,8	18,5	4,0	10,2	22,5	9,7	22,0
5,0	8,7	20,5	8,6	20,1	5,0	11,0	25,7	10,6	24,7
6,0	9,3	22,4	9,2	21,7	6,0	12,1	27,4	11,7	26,7
7,0	10,2	22,8	9,8	23,3	7,0	12,5	30,0	12,5	28,7
8,0	10,4	24,0	9,9	23,8	8,0	12,7	31,5	13,4	30,7
9,0	10,9	25,7	10,2	24,8	9,0	13,7	33,5	13,8	32,5
10,0	11,2	26,0	10,5	25,6	10,0	14,3	33,7	14,1	34,0
11,0	11,4	26,7	10,7	26,2	11,0	14,8	34,6	14,6	35,0
12,0	11,4	27,5	10,8	27,5	12,0	15,7	35,3	14,8	35,3
13,0	11,8	29,0	10,9	28,0	13,0	16,4	37,3	15,3	36,6
14,0	10,4	29,2	10,5	27,7	14,0	16,5	37,6	15,6	36,7
15,0	10,0	27,6	10,2	27,2	15,0	17,0	39,3	15,7	37,8
16,0	9,6	27,4	10,0	26,8	16,0	17,5	39,6	15,9	40,6
17,0	9,1	25,8	9,6	27,5	17,0	16,8	40,6	15,9	41,1
18,0	9,2	26,4	8,5	27,6	18,0	15,7	41,7	16,0	41,3
19,0	9,0	27,1	8,2	27,5	19,0	16,4	42,4	16,0	41,5
20,0	7,9	27,0	7,3	27,2	20,0	15,5	43,8	16,0	41,8

Page No.32

AUTOTEST -AT NM/M

Type	Version	Light Source	Light Flux / Emergency mode	Battery	Order Code	Weight
PERUN2-AT.1h	NM/M	MidPower LEDs	1650 lm / 1650 lm	LiFePo4 6,4V/4,5Ah	19-B-100-04-00-00	2,6 kg

DALI SELF-CONTAINED

Type	Version	Light Source	Light Flux / Emergency mode	Battery	Order Code	Weight
PERUN2-DALI.1h	NM/M	MidPower LEDs	1650 lm / 1650 lm	LiFePo4 6,4V/4,5Ah	19-B-101-04-00-00	2,6 kg

Page No.36

CENTRALTEST -ATXL ELMAX-LOOK

Type	Version	Light Source	Light Flux / Emergency mode	Battery	Order Code	Weight
PERUN2-ATXL.1h	NM/M	MidPower LEDs	1650 lm / 1650 lm	LiFePo4 6,4V/4,5Ah	19-B-102-04-00-00	2,6 kg

Page No.44

CENTRAL BATTERY (CBS)

Type	Version	Light Source	Light Flux	Order Code	Weight
C.PERUN2 230V AC/DC	CBS NON-ADDRESSABLE	MidPower LEDs	3900 lm	19-B-103-00-00-00	2,0 kg
C.PERUN2 24V DC	CBS NON-ADDRESSABLE	MidPower LEDs	1650 lm	19-B-104-00-00-00	4,0 kg
C.PERUN2 110V DC	CBS NON-ADDRESSABLE	MidPower LEDs	1650 lm	19-B-105-00-00-00	4,0 kg

DALI CENTRAL BATTERY (CBS)

Type	Version	Light Source	Light Flux	Order Code	Weight
C.PERUN2-DALI 230V AC	DALI CBS	MidPower LEDs	1650 lm	19-B-106-00-00-00	2,0 kg

Page No.40

Addressable CENTRAL BATTERY (CBS) -ATXP ELMAX-PATROLUX

Type	Version	Light Source	Light Flux	Order Code	Weight
C.PERUN2-ATXP 230V AC/DC	ATXP CBS ADDRESSABLE	MidPower LEDs	3900 lm	19-B-107-00-00-00	2,0 kg

HIGH CEILING ANTIPANIC LIGHTING ROTALUX2

**FOR HIGH CEILING >4m
PRE VYSOKÉ STROPY >4m**



HIGH CEILING >4m



HIGH CEILING >4m

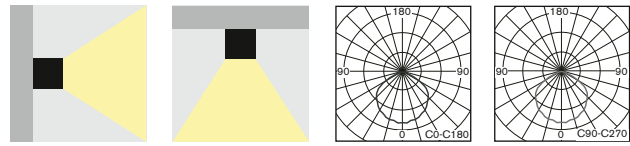

- **POWERFULL rotatable** ceiling or wall mounted LED fixture available for all non-maintained (NM), maintained (M) or centralised (C) emergency lighting especially designed for **HIGH CEILING applications where the lighting beam needs to be directed.**

It is available in all following versions:

- **AUTOTEST (-AT)**
- **DALI**
- **CENTRALTEST (-ATXL)** for ELMAX LOOK system (look up also page No.36)
- **CENTRAL BATTERY (C.ROTALUX2)** for **non-addressable CBS** (page 44)
- **CENTRAL BATTERY (-ATXP)** for system **ELMAX-PATROLUX & Addressable CBS** (look up also page No.40)
- Conforming to the requirement of EN60598-2-22, EN1838, EN62034
- Design:
 - metal sheet body with powder coat finish RAL9006 (grey) or RAL9003 (white)
 - impact resistant polycarbonate diffuser (PC)
- výkonné LED svietidlo **s otočným kĺbom** pre **netrvalé (NM), trvalé (M)** alebo **centrálne (C)** núdzové osvetlenie pre povrchovú montáž na strop alebo kólmú stenu **špeciálne navrhnuté pre aplikácie VO VEĽKÝCH VÝŠKACH** ako napr. výrobné haly, športové haly, sklady,...všade tam, kde je potrebná možnosť smerovania svetelného toku pomocou otočného kĺbu, aj s funkciami:
 - **AUTOTEST (-AT),**
 - **DALI**
 - **CENTRALTEST (-ATXL)** pre systém ELMAX LOOK (pozri str.36)
 - **CENTRAL BATTERY (C.ROTALUX2)** pre **neadresovateľné CBS** (str.44)
 - **CENTRAL BATTERY (-ATXP)** pre systém **ELMAX-PATROLUX s adresovateľnou CBS** (pozri str. 40)
- spĺňa požiadavky európskej normy EN 60598-2-22, EN1838, EN62034
- konštrukcia:
 - teleso z plechu vo farbe RAL9006 (šedá) alebo RAL9003 (biela)
 - svetelno-činný kryt z nerozbitného polykarbonátu

STANDARD FEATURES

ŠTANDARDNÁ VÝBAVA

- **High efficient MidPower (150lm/W, 5000K) LONGLIFE LEDs (>100.000h)**
- **Rod-end bearing** allowing to direct the lighting beam to the required area
- **NEW Advanced Electronics**
- **LONGLIFE LIFEPO4 battery**
- **Installation Mode** (battery protection, for more details look up page No.51)
- **Intelligent battery charging** (intermittent charging, look up page No.51)
- **Jumper** allowing to preset following functions:
 - **INSTALLATION MODE** activation/deactivation (look up page No.51)
 - **Maintained mode** activation/deactivation
- Addressable **CENTRALTEST** communication module (for ATXL, ATRF, ATXP only)
- LEDs indicating presence of power supply and signaling failures & TEST button
- **vysoke účinné MidPower LED (150lm/W, 5000K) so životnosťou min.100000h**
- **guľový kĺb** umožňujúci nasmerovanie svetelného toku do požadovaného priestoru (napr. nad výrobnú technológiu, nakladačiu rampu a pod.)
- **progresívna elektronická jednotka**
- **LONGLIFE LIFEPO4 batéria**
- **Inštalčný mód** (ochrana batérie, pozri aj str.51)
- **Inteligentné nabíjanie batérie** ("intermittent" nabíjanie, pozri aj str.51)
- **Jumper** umožňujúci prednastavenie funkcií:
 - **Instalačný mód** aktivácia / deaktivácia (pozri aj str.51)
 - trvalé núdzové osvetlenie aktivácia / deaktivácia
- adresovateľný **CENTRALTEST** komunikačný modul (len pre ATXL, ATRF, ATXP verzie)
- signalizácia LED a TEST tlačítko

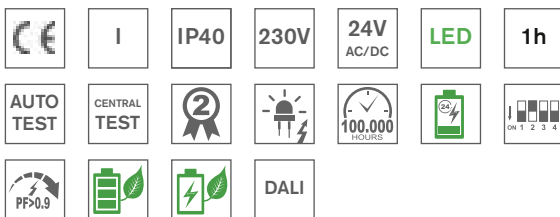

Input Power:

- 17W/ 19VA (maintained M)
- 4,0W/ 5,0VA (non-maintained NM)
- 33W/36VA (CBS)

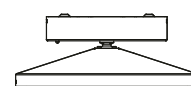
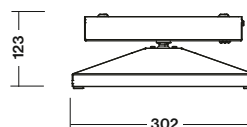
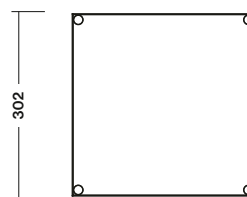

HIGH CEILING ANTIPANIC LIGHTING ROTALUX2

MULTIROTALUX2-AT 1h (1650lm) 1LX SPACING TABLE					C.ROTALUX2 (3900lm) 1LX SPACING TABLE				
H (m)	X1 (m)	X2 (m)	Y1 (m)	Y2 (m)	H (m)	X1 (m)	X2 (m)	Y1 (m)	Y2 (m)
4,0	7,9	18,2	7,9	18,2	4,0	9,0	20,0	9,0	20,0
5,0	9,0	20,8	9,0	20,8	5,0	10,5	23,2	10,5	23,2
6,0	9,7	23,3	9,7	23,3	6,0	11,8	26,3	11,8	26,3
7,0	10,4	25,4	10,4	25,4	7,0	13,0	28,9	13,0	28,9
8,0	11,0	27,1	11,0	27,1	8,0	14,0	31,6	14,0	31,6
9,0	11,4	28,3	11,4	28,3	9,0	14,7	34,0	14,7	34,0
10,0	11,5	29,8	11,5	29,8	10,0	15,5	35,8	15,5	35,8
11,0	11,6	31,0	11,6	31,0	11,0	15,8	37,7	15,8	37,7
12,0	11,6	31,7	11,6	31,7	12,0	16,3	39,3	16,3	39,3
13,0	11,5	32,2	11,5	32,2	13,0	16,7	40,5	16,7	40,5
14,0	11,2	32,6	11,2	32,6	14,0	16,8	41,3	16,8	41,3
15,0	11,0	32,7	11,0	32,7	15,0	17,0	42,0	17,0	42,0
16,0	10,8	32,8	10,8	32,8	16,0	17,3	42,8	17,3	42,8
17,0	10,1	32,6	10,1	32,6	17,0	17,3	43,4	17,3	43,4
18,0	9,5	32,5	9,5	32,5	18,0	17,3	43,7	17,3	43,7
19,0	8,8	32,1	8,8	32,1	19,0	17,3	44,3	17,3	44,3
20,0	8,1	31,8	8,1	31,8	20,0	17,0	44,5	17,0	44,5

Light source	LED 5000K
LED Light output	1650lm / 3900lm
Housing colour	RAL9003 White RAL9006 Grey
Application	High Ceiling Anti-panic lighting
Max room illumination	up to 1520m² > 0.5lx (valid for C.ROTALUX2 CBS version)

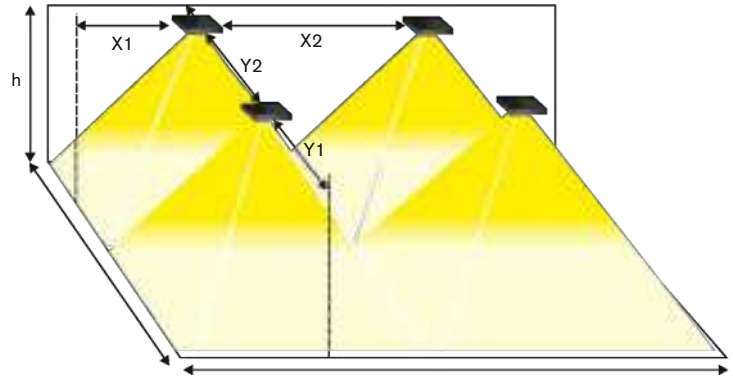

Page No.32

AUTOTEST -AT NM/M

Type	Colour	Light Source	Light Flux / Emergency mode	Battery	Order Code	Weight
MULTIROTALUX2-AT.1h RAL9003	White / biela	MidPower LEDs	1650 lm / 1650 lm	LiFePo4 6,4V/4,5Ah	165-B-100-04-00-01	4,6 kg
MULTIROTALUX2-AT.1h RAL9006	Grey / šedá	MidPower LEDs	1650 lm / 1650 lm	LiFePo4 6,4V/4,5Ah	165-B-100-04-00-02	4,6 kg

DALI SELF-CONTAINED

Type	Colour	Light Source	Light Flux / Emergency mode	Battery	Order Code	Weight
MULTIROTALUX2-DALI.1h RAL9003	White / biela	MidPower LEDs	1650 lm / 1650 lm	LiFePo4 6,4V/4,5Ah	165-B-105-04-00-01	4,6 kg
MULTIROTALUX2-DALI.1h RAL9006	Grey / šedá	MidPower LEDs	1650 lm / 1650 lm	LiFePo4 6,4V/4,5Ah	165-B-105-04-00-02	4,6 kg

Page No.36

CENTRALTEST -ATXL ELMAX-LOOK

Type	Colour	Light Source	Light Flux / Emergency mode	Battery	Order Code	Weight
MULTIROTALUX2-ATXL.1h RAL9003	White / biela	MidPower LEDs	1650 lm / 1650 lm	LiFePo4 6,4V/4,5Ah	165-B-101-04-00-01	4,7 kg
MULTIROTALUX2-ATXL.1h RAL9006	Grey / šedá	MidPower LEDs	1650 lm / 1650 lm	LiFePo4 6,4V/4,5Ah	165-B-101-04-00-02	4,7 kg

Page No.44

CENTRAL BATTERY (CBS)

Type	Colour	Version	Light Source	Light Flux	Order Code	Weight
C.ROTALUX2 230V AC/DC RAL9003	White / biela	CBS NON-ADDRESSABLE	MidPower LEDs	3900 lm	165-B-102-00-01	4,0 kg
C.ROTALUX2 230V AC/DC RAL9006	Grey / šedá	CBS NON-ADDRESSABLE	MidPower LEDs	3900 lm	165-B-102-00-02	4,0 kg
C.ROTALUX2 24V AC/DC RAL9003	White / biela	CBS NON-ADDRESSABLE	MidPower LEDs	1650 lm	165-B-103-00-01	4,0 kg
C.ROTALUX2 24V AC/DC RAL9006	Grey / šedá	CBS NON-ADDRESSABLE	MidPower LEDs	1650 lm	165-B-103-00-02	4,0 kg

DALI CENTRAL BATTERY (CBS)

Type	Colour	Version	Light Source	Light Flux	Order Code	Weight
C.ROTALUX2-DALI 230V AC RAL9003	White / biela	DALI CBS	MidPower LEDs	1650 lm	165-B-106-00-00-01	4,0 kg
C.ROTALUX2-DALI 230V AC RAL9006	Grey / šedá	DALI CBS	MidPower LEDs	1650 lm	165-B-106-00-00-01	4,0 kg

Page No.40

Addressable CENTRAL BATTERY (CBS) -ATXP ELMAX-PATROLUX

Type	Colour	Version	Light Source	Light Flux	Order Code	Weight
C.ROTALUX2-ATXP 230V AC/DC RAL9003	White / biela	ATXP CBS ADDRESSABLE	MidPower LEDs	3900 lm	165-B-104-00-01	4,0 kg
C.ROTALUX2-ATXP 230V AC/DC RAL9006	Grey / šedá	ATXP CBS ADDRESSABLE	MidPower LEDs	3900 lm	165-B-104-00-02	4,0 kg

HIGH CEILING ANTIPANIC LIGHTING ROTALUX2



Light source	LED 5000K
LED Light output	1650lm / 3900lm
Housing colour	RAL9003 White RAL9006 Grey
Application	High Ceiling Anti-panic lighting
Max room illumination	up to 1520m² > 0.5lx (valid for C.ROTALUX2 CBS version)

HIGH CEILING ANTIPANIC LIGHTING POWERLUX2



Light source	LED 5000K
LED Light output	1750lm / 3900lm
Housing colour	RAL9003 White RAL9006 Grey
Application	High Ceiling Anti-panic lighting
Max room illumination	up to 1520m² > 0.5lx (valid for C.POWERLUX2 CBS version)



HIGH CEILING >4m



HIGH CEILING >4m



HIGH CEILING >4m

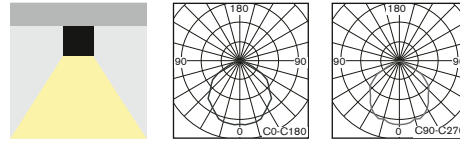

- **POWERFULL** ceiling mounted LED fixture available for all non-maintained (NM), maintained (M) or centralised (C) emergency lighting especially designed for **HIGH CEILING applications**

It is available in all following versions:

- **AUTOTEST** (-AT)
- **CENTRALTEST** (-ATXL) for ELMAX LOOK system (look up also page No.36)
- **CENTRAL BATTERY** (C.POWERLUX2) for **non-addressable CBS** (look up also page No.44)
- **CENTRAL BATTERY** (-ATXP) for system **ELMAX-PATROLUX & Addressable CBS** (look up also page No.40)
- **DALI**
- Conforming to the requirement of EN60598-2-22, EN1838, EN62034
- Design:
 - metal sheet body with powder coat finish either RAL9006 (grey) or RAL9003 (white) or RAL9005 (black)
 - impact resistant polycarbonate diffuser (PC)

- **NOVÝ typ** výkonného LED svietidla pre **netrvalé (NM), trvalé (M) alebo centrálne (C) núdzové osvetlenie** pre povrchovú montáž **špeciálne navrhnuté pre aplikácie vo veľkých výškach** ako napr. výrobné haly, športové haly, sklady,...všade tam, kde je potrebná vysoký výkon v núdzovom režime, aj s funkciami:

- **AUTOTEST** (-AT)
- **CENTRALTEST** (-ATXL) pre systém ELMAX LOOK (pozri str.36)
- **CENTRAL BATTERY** (C.POWERLUX2) pre **neadresovateľné CBS** (pozri str.44)
- **CENTRAL BATTERY** (-ATXP) pre systém **ELMAX-PATROLUX s adresovateľnou CBS** (pozri aj str.40)
- **DALI**
- spĺňa požiadavky európskej normy EN 60598-2-22, EN1838, EN62034
- konštrukcia:
 - teleso z plechu vo farbe RAL9006 (šedá), RAL9003 (biela) alebo RAL9005 (čierna)
 - svetelno-činný kryt z nerozbitného polykarbonátu

STANDARD FEATURES

STANDARDNÁ VÝBAVA

- **High efficient MidPower (150lm/W) LONGLIFE LEDs (>100.000h) 5000K**
- **NEW Advanced Electronics**
- **LONGLIFE battery**
- **Installation Mode** (battery protection, for more details look up page No.51)
- **Intelligent battery charging** (intermittent charging, look up page No.51)
- **Jumper** allowing to preset following functions:
 - **INSTALLATION MODE** activation/deactivation (look up page No.51)
 - **Maintained mode** activation/deactivation
- Addressable CENTRALTEST communication module (for ATXL, ATRF, ATXP only)
- LEDs indicating presence of power supply and signaling failures & TEST button
- **vysoko účinné MidPower LED (150lm/W) so životnosťou min.100000h (5000K)**
- **progressívna elektronická jednotka**
- **LONGLIFE batéria**
- **Inštalčný mód** (ochrana batérie, pozri aj str.51)
- **Inteligentné nabíjanie batérie** ("intermittent" nabíjanie, pozri aj str.51)
- **Jumper** umožňujúci prednastavenie funkcií:
 - **Inštalčný mód** aktivácia / deaktivácia (pozri aj str.51)
 - trvalé núdzové osvetlenie aktivácia / deaktivácia
- adresovateľný CENTRALTEST komunikačný modul (len pre ATXL, ATRF, ATXP verzie)
- signalizácia LED a TEST tlačítko

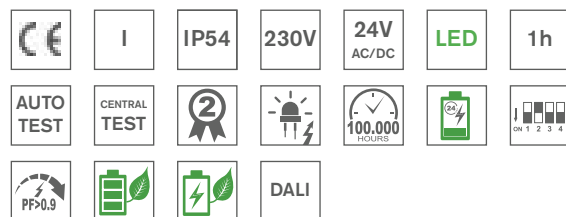

Input Power:

- 17W/ 19VA (maintained M)
- 4,0W/ 5,0VA (non-maintained NM)
- 33W/ 36VA (CBS)

HIGH CEILING ANTIPANIC LIGHTING POWERLUX2

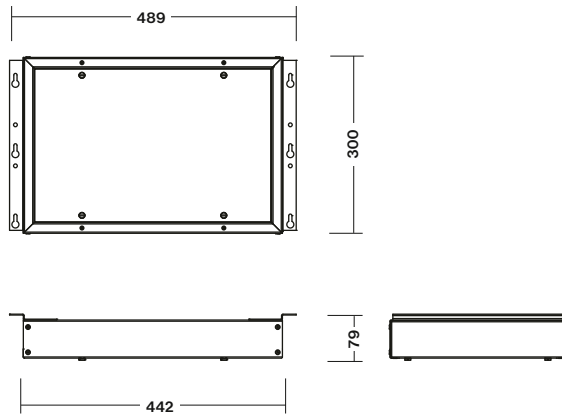

Light source	LED 5000K
LED Light output	1650lm / 3900lm
Housing colour	RAL9003 White RAL9006 Grey
Application	High Ceiling Anti-panic lighting
Max room illumination	up to 1520m² > 0.5lx (valid for C.POWERLUX2 CBS version)

Page No.32

AUTOTEST -AT NM/M

Type	Colour	Light Source	Light Flux / Emergency mode	Battery	Order Code	Weight
MULTIPOWER2-AT.1h RAL9003	White / biela	MidPower LEDs	1650 lm / 1650 lm	LiFePo4 6,4V/4,5Ah	15-B-100-04-00-01	5,7 kg
MULTIPOWER2-AT.1h RAL9006	Grey / šedá	MidPower LEDs	1650 lm / 1650 lm	LiFePo4 6,4V/4,5Ah	15-B-100-04-00-02	5,7 kg
MULTIPOWER2-AT.1h RAL9005	Black / čierna	MidPower LEDs	1650 lm / 1650 lm	LiFePo4 6,4V/4,5Ah	15-B-100-04-00-03	5,7 kg

DALI SELF-CONTAINED

Type	Colour	Light Source	Light Flux / Emergency mode	Battery	Order Code	Weight
MULTIPOWER2-DALI.1h RAL9003	White / biela	MidPower LEDs	1650 lm / 1650 lm	LiFePo4 6,4V/4,5Ah	15-B-106-04-00-01	5,7 kg
MULTIPOWER2-DALI.1h RAL9006	Grey / šedá	MidPower LEDs	1650 lm / 1650 lm	LiFePo4 6,4V/4,5Ah	15-B-106-04-00-02	5,7 kg
MULTIPOWER2-DALI.1h RAL9005	Black / čierna	MidPower LEDs	1650 lm / 1650 lm	LiFePo4 6,4V/4,5Ah	15-B-106-04-00-03	5,7 kg

Page No.36

CENTRALTEST -ATXL ELMAX-LOOK

Type	Colour	Light Source	Light Flux / Emergency mode	Battery	Order Code	Weight
MULTIPOWER2-ATXL.1h RAL9003	White / biela	MidPower LEDs	1650 lm / 1650 lm	LiFePo4 6,4V/4,5Ah	15-B-101-04-00-01	5,8 kg
MULTIPOWER2-ATXL.1h RAL9006	Grey / šedá	MidPower LEDs	1650 lm / 1650 lm	LiFePo4 6,4V/4,5Ah	15-B-101-04-00-02	5,8 kg
MULTIPOWER2-ATXL.1h RAL9005	Black / čierna	MidPower LEDs	1650 lm / 1650 lm	LiFePo4 6,4V/4,5Ah	15-B-101-04-00-03	5,8 kg

Page No.44

CENTRAL BATTERY (CBS)

Type	Colour	Version	Light Source	Light Flux	Order Code	Weight
C.POWERUX2/230V AC/DC RAL9003	White / biela	CBS NON-ADDRESSABLE	MidPower LEDs	3900 lm	15-B-102-00-01	4,5 kg
C.POWERUX2/230V AC/DC RAL9006	Grey / šedá	CBS NON-ADDRESSABLE	MidPower LEDs	3900 lm	15-B-102-00-02	4,5 kg
C.POWERUX2/230V AC/DC RAL9005	Black / čierna	CBS NON-ADDRESSABLE	MidPower LEDs	3900 lm	15-B-102-00-03	4,5 kg
C.POWERUX2/24V AC/DC RAL9003	White / biela	CBS NON-ADDRESSABLE	MidPower LEDs	1650 lm	15-B-103-00-01	4,5 kg
C.POWERUX2/24V AC/DC RAL9006	Grey / šedá	CBS NON-ADDRESSABLE	MidPower LEDs	1650 lm	15-B-103-00-02	4,5 kg
C.POWERUX2/24V AC/DC RAL9005	Black / čierna	CBS NON-ADDRESSABLE	MidPower LEDs	1650 lm	15-B-103-00-03	4,5 kg

DALI CENTRAL BATTERY (CBS)

Type	Colour	Version	Light Source	Light Flux	Order Code	Weight
C.POWERUX2/230V AC/DC RAL9003	White / biela	DALI CBS	MidPower LEDs	1650 lm	15-B-107-00-00-01	4,5 kg
C.POWERUX2/230V AC/DC RAL9006	Grey / šedá	DALI CBS	MidPower LEDs	1650 lm	15-B-107-00-00-02	4,5 kg
C.POWERUX2/230V AC/DC RAL9005	Black / čierna	DALI CBS	MidPower LEDs	1650 lm	15-B-107-00-00-03	4,5 kg

Page No.40

Addressable CENTRAL BATTERY (CBS) -ATXP ELMAX-PATROLUX

Type	Colour	Version	Light Source	Light Flux	Order Code	Weight
C.ROTALUX2-ATXPR/230V AC/DC RAL9003	White / biela	ATXP CBS ADDRESSABLE	MidPower LEDs	3900 lm	15-B-104-00-01	4,5 kg
C.ROTALUX2-ATXPR/230V AC/DC RAL9006	Grey / šedá	ATXP CBS ADDRESSABLE	MidPower LEDs	3900 lm	15-B-104-00-02	4,5 kg
C.ROTALUX2-ATXPR/230V AC/DC RAL9005	Black / čierna	ATXP CBS ADDRESSABLE	MidPower LEDs	3900 lm	15-B-104-00-03	4,5 kg

Look up pages No. 210-217 for 1lx Spacing tables
Pozri str.210-217 pre rozmiestnenie svetidiel na dosiahnutie 1lx



HIGH CEILING ANTIPANIC LIGHTING POWERLUX2

FOR HIGH CEILING >4m
PRE VYSOKÉ STROPY >4m

MULTIPOWER2-AT 1h (1650lm)				
1LX SPACING TABLE				
H (m)	X1 (m)	X2 (m)	Y1 (m)	Y2 (m)
4,0	7,9	18,2	7,9	18,2
5,0	9,0	20,8	9,0	20,8
6,0	9,7	23,3	9,7	23,3
7,0	10,4	25,4	10,4	25,4
8,0	11,0	27,1	11,0	27,1
9,0	11,4	28,3	11,4	28,3
10,0	11,5	29,8	11,5	29,8
11,0	11,6	31,0	11,6	31,0
12,0	11,6	31,7	11,6	31,7
13,0	11,5	32,2	11,5	32,2
14,0	11,2	32,6	11,2	32,6
15,0	11,0	32,7	11,0	32,7
16,0	10,8	32,8	10,8	32,8
17,0	10,1	32,6	10,1	32,6
18,0	9,5	32,5	9,5	32,5
19,0	8,8	32,1	8,8	32,1
20,0	8,1	31,8	8,1	31,8

C.POWERLUX2 (3900lm)				
1LX SPACING TABLE				
H (m)	X1 (m)	X2 (m)	Y1 (m)	Y2 (m)
4,0	9,0	20,0	9,0	20,0
5,0	10,5	23,2	10,5	23,2
6,0	11,8	26,3	11,8	26,3
7,0	13,0	28,9	13,0	28,9
8,0	14,0	31,6	14,0	31,6
9,0	14,7	34,0	14,7	34,0
10,0	15,5	35,8	15,5	35,8
11,0	15,8	37,7	15,8	37,7
12,0	16,3	39,3	16,3	39,3
13,0	16,7	40,5	16,7	40,5
14,0	16,8	41,3	16,8	41,3
15,0	17,0	42,0	17,0	42,0
16,0	17,3	42,8	17,3	42,8
17,0	17,3	43,4	17,3	43,4
18,0	17,3	43,7	17,3	43,7
19,0	17,3	44,3	17,3	44,3
20,0	17,0	44,5	17,0	44,5

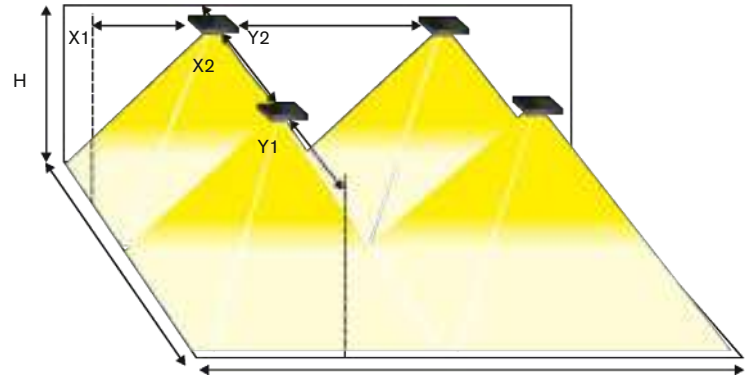

Product
Assortment

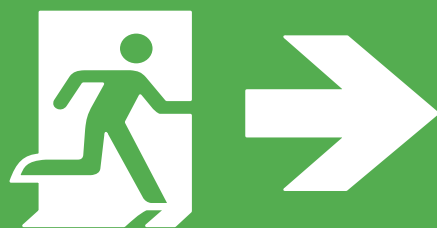

**EMERGENCY
LIGHTING**

**NÚDZOVÉ
SVIETIDLÁ**

PREMIUM Line (Page No: 170-181)
CINEMA Applications (NO AUTOTEST)

CINEMA EMERGENCY LIGHTING

ASSORTMENT

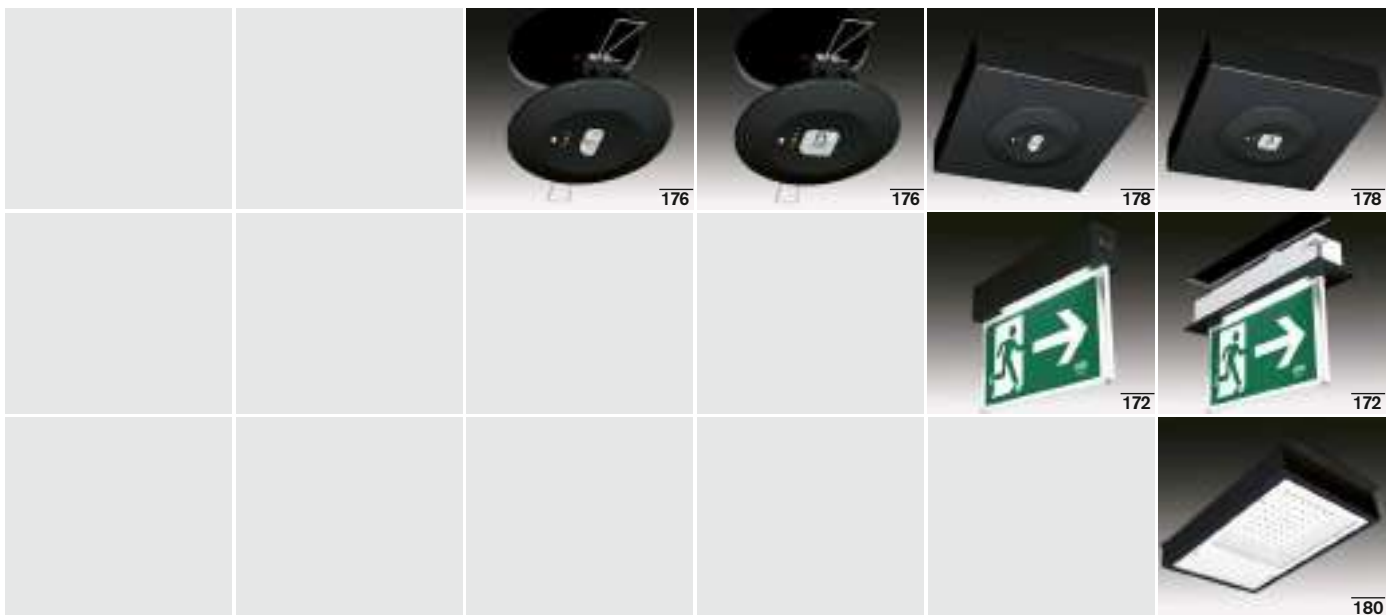

CINEMA LED Fixtures are especially designed for CINEMA / THEATRE applications. The surface is painted in black matt colour to avoid reflections. AUTOTEST function is not active to avoid testing procedure (LED ON) during cinema / theatre performance.

Typová rada **CINEMA** je určená pre núdzové osvetlenie priestorov kín a divadiel. Teleso svietidiel je lakované matnou čiernou farbou. Funkcia AUTOTEST nie je aktívna, aby neprišlo k testu a tým nežiadúcemu rozsvieteniu počas predstavenia.

NO-AUTOTEST EMERGENCY LIGHTING LEDLUX2 CINEMA



Surface Mounted (all "-P" versions)
Prisadená verzia (všetky "-P" verzie)



Recessed Mounted (all "-V" versions)
Zapustená montáž do stropu (všetky "-V" verzie)



- Modern design orientated **surface mounted LED** non-maintained/maintained (NM/M) emergency lighting with smooth legend illumination especially designed for cinema / theatre applications.
- **AUTOTEST** function is deactivated to avoid testing (LED ON) during the movie or theatre performance
- Legend luminance $>200\text{cd/m}^2$ (white), dimmable (see setup on page 175)
- Conforming to the requirement of EN60598-2-22, EN1838, EN62034
- Design: metal sheet body with PE powder coat finish matt RAL9005 (black)
- Elegantné stropné LED svietidlá pre **netrvalé/trvalé (NM/M)** núdzové osvetlenie s perfektnou rovnomernosťou osvetlenia piktogramu **navrhnuté špeciálne pre použitie v kinách a divadlách**
- **AUTOTEST** funkcia je deaktivovaná, aby sa zamedžilo nežiadúcemu rozsvieteniu LED počas predstavenia
- spĺňa požiadavky európskej normy EN 60598-2-22, EN1838, EN62034
- Jas piktogramu $>200\text{cd/m}^2$ (white), nastaviteľné (pozri str.175)
- konštrukcia: teleso z oceľového plechu vo farbe RAL9005 (čierna matná)

STANDARD FEATURES

STANDARDNÁ VÝBAVA

- **High efficient MidPower (150lm/W, 5000K) LONGLIFE LEDs (>100.000h)**
- **NEW Advanced Electronics**
- **LONGLIFE LiFePo4 battery**
- **Installation Mode** (battery protection, for more details look up page No.51+175)
- **Intelligent battery charging** (intermittent charging, look up page No.51+175)
- **DIP Switch** allowing to preset following functions:
 - **ECO Mode** (dimming 10%-100%, for more details look up page No.51+175)
- LEDs indicating presence of power supply and signaling failures & TEST button
- **vysoce účinné MidPower LED (150lm/W, 5000K) so životnosťou min.100000h**
- **progresívna elektronická jednotka**
- **LONGLIFE LiFePo4 batéria**
- **Inštaláčny mód** (ochrana batérie, pozri aj str.51+175)
- **Inteligentné nabíjanie batérie** ("intermittent" nabíjanie, pozri aj str.51+175)
- **DIP prepínač** umožňujúci prednastavenie funkcií:
 - **ECO Mód** (stmievanie 10%-100%, pozri aj str.51+175)
- signalizácia LED a TEST tlačítko

OPTIONAL ACCESSORIES

PRÍPLATKY

- **Special suspended plexi with layered design for perfect uniform illumination of legend - must be ordered as a separate item (look up also page No.173)**
- Wall or ceiling mounting brackets (look up also page No.174)
- Wire rope suspension set (look up also page No.174)
- **špeciálne vrstvené závesné plexi pre rovnomerné osvetlenie piktogramu na jeho celej ploche (plexi musí byť objednané samostatne podľa želaného piktogramu- pozri aj str.173)**
- nástenná, stropná alebo stropná závesná konzola (pozri aj str.174)
- lanková závesná sada (pozri aj str.174)

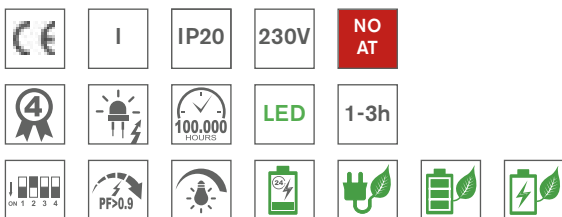

Input Power:

- 5,3W/ 5,6VA (maintained M)
- 2,0W/ 3,8VA (non-maintained NM)
- 3,0W/ 5,1VA (CBS)

Parallel wall mounting bracket
Konzola rovnobežne so stenou



RAL9005

Upright wall mounting bracket
Konzola kolmo na stenu



RAL9005

Recessed mounting hole size: 340 x 65 mm
Rozmer montážneho otvoru : 340 x 65 mm

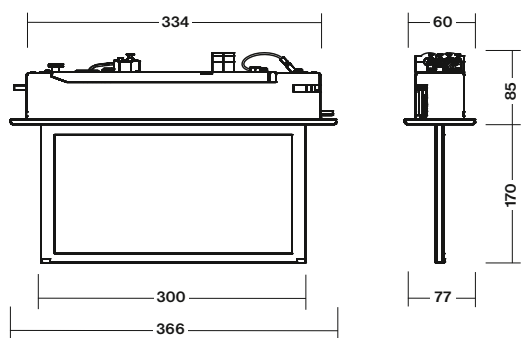

NO-AUTOTEST EMERGENCY LIGHTING LEDLUX2 CINEMA

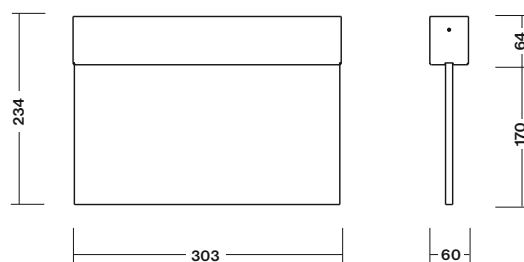

Surface Mounting **NO-AUTOTEST NM/M**

Type	Version	Colour	Light Source	Duration	Battery	Order Code	Weight
MULTILED2-P.3h NO-AT	Only Body, No Plexi incl.	Black / čierna	MidPower LEDs	3h	LiFePo4 6,4V/1,0Ah	309-B-018-04-00-03	1,2 kg

Recessed Mounting **NO-AUTOTEST NM/M**

Type	Version	Colour	Light Source	Duration	Battery	Order Code	Weight
MULTILED2-V.3h NO-AT	Only Body, No Plexi incl.	Black / čierna	MidPower LEDs	3h	LiFePo4 6,4V/1,0Ah	309-B-118-04-00-03	1,2 kg

Suspended Plexi / závesné plexi s piktogramom



• It is not included in standard package. It must be ordered as separate item !

- Viewing Distance: 30m
- Complying ISO7010
- Legend luminance >500cd/m² (white)

• nie je súčasťou štandardného balenia svietidla, musí byť objednané ako samostatná položka !

- rozoznatelnosť piktogramu: 30m
- v súlade s ISO7010
- jas piktogramu >500cd/m² (biela)



Suspended plexi Accessory

Optional Item	Order Code
Double sided plexi with legend H/J	309-B-000-00-00-01
Double sided plexi with legend I	309-B-000-00-00-02
Single sided plexi with legend H	309-B-000-00-00-03
Single sided plexi with legend I	309-B-000-00-00-04
Single sided plexi with legend J	309-B-000-00-00-05
Double sided plexi with legend K/M	309-B-000-00-00-06
Double sided plexi with legend L/N	309-B-000-00-00-07
Single sided plexi with legend K	309-B-000-00-00-08
Single sided plexi with legend L	309-B-000-00-00-09
Single sided plexi with legend M	309-B-000-00-00-10
Single sided plexi with legend N	309-B-000-00-00-11
Single sided plexi with legend O	309-B-000-00-00-12
Double sided plexi with legend O	309-B-000-00-00-13
Double sided plexi with legend Z1	309-B-000-00-00-27
Double sided plexi with legend Z2	309-B-000-00-00-28

Závesné plexi s piktogramom

Priplatok	Objednávaci kód
Obojstranné plexi s piktogramom H/J	309-B-000-00-00-01
Obojstranné plexi s piktogramom I	309-B-000-00-00-02
Jednostranné plexi s piktogramom H	309-B-000-00-00-03
Jednostranné plexi s piktogramom I	309-B-000-00-00-04
Jednostranné plexi s piktogramom J	309-B-000-00-00-05
Obojstranné plexi s piktogramom K/M	309-B-000-00-00-06
Obojstranné plexi s piktogramom L/N	309-B-000-00-00-07
Jednostranné plexi s piktogramom K	309-B-000-00-00-08
Jednostranné plexi s piktogramom L	309-B-000-00-00-09
Jednostranné plexi s piktogramom M	309-B-000-00-00-10
Jednostranné plexi s piktogramom N	309-B-000-00-00-11
Jednostranné plexi s piktogramom O	309-B-000-00-00-12
Obojstranné plexi s piktogramom O	309-B-000-00-00-13
Obojstranné plexi s piktogramom Z1	309-B-000-00-00-27
Obojstranné plexi s piktogramom Z2	309-B-000-00-00-28

**Optional Accessories:**

- Wall brackets
- Wire rope suspension set

Priplatky:

- nástenné konzoly
- lankový záves

Parallel wall mounting bracket
Konzola rovnobežne so stenou



RAL9005

Upright wall mounting bracket
Konzola kolmo na stenu



RAL9005

Optional Item / Priplatky	Order Code
Parallel wall mounting bracket in black RAL9005 colour / nástenná konzola rovnobežne so stenou v čiernej RAL9005	309-B-000-01-01-03
Upright wall mounting bracket in black RAL9005 colour / konzola kolmo na stenu v čiernej RAL9005	309-B-000-03-01-03
Wire rope suspension set 1,0m long in black RAL9005 colour / lanková závesná sada 1,0m dlhá v čiernej RAL9005 farbe	85-B-05-13-02



DIP-SWITCH SET-UP FEATURES LEDLUX2 CINEMA



DIP SWITCH FEATURES No.1 DIP PREPÍNAČ č.1- FUNKCIE

DIP SWITCH FEATURES No.2-4 DIP PREPÍNAČ č.2-4 - FUNKCIE

NORMAL MODE 230V MAINS

EMERGENCY MODE BATTERY

ESCAPE SIGN Brightness in 230V
OFF = 100%
BRIGHTNESS > 200cd/m²

ECO MODE 10% (in 230V Mode)
ON = 10%
BRIGHTNESS > 2cd/m²

INSTALLATION MODE SET UP

NON-MAINTAINED / MAINTAINED MODE SET UP

M / NM

DEFAULT SETTING / PREDNASTAVENÉ
OFF - ACTIVATED
ON - DEACTIVATED

DEFAULT SETTING / PREDNASTAVENÉ
ON - MAINTAINED
OFF - NON-MAINTAINED

TO SEE THE CHANGE PUSH EITHER TEST BUTTON OR DISCONNECT THE FIXTURE FROM BOTH THE MAINS 230V AND BATTERY
Po prestavení stlačte TEST alebo odpojte batériu a 230V napájanie na aktiváciu zmeny



NO-AUTOTEST EMERGENCY LIGHTING FOR RECESSED MOUNTING LEDLUX-SPOT2-V CINEMA



Escape Route Corridor Application "A" version



Open Area Application "B" version

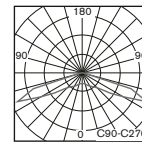
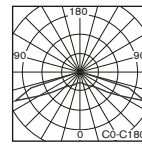
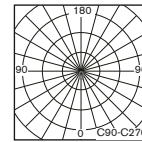
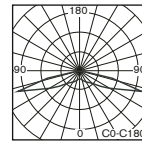
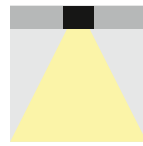

- Escape Route Corridor Application
- All "A" versions
- Osvetlenie únikových ciest
- všetky "A" verzie

- Antipanic Open Area Application
- All "B" versions
- Antipanic osvetlenie
- všetky "B" verzie

- Modern design orientated **recessed mounted LED** non-maintained/maintained (NM/M) emergency lighting especially designed for cinema / theatre applications
- Perfect light distribution **especially** designed for a **corridor applications (all versions "A" - escape route illumination to EN1838) or open area antipanic (all versions "B")**
- **AUTOTEST** function is deactivated to avoid testing (LED ON) during the movie or theatre performance

It is available in all following versions:

- **SELFCONTAINED (NO-AT)**
- **CENTRAL BATTERY (C.LEDLUX-SPOT2)** for **non-addressable CBS** (look up also page No.44)
- Conforming to the requirement of EN60598-2-22, EN1838, EN62034
- Design: plastic body in RAL9005 (black)

- Elegánnté stropné zapustené LED svietidlá pre **netrválé/trvalé (NM/M)** núdzové osvetlenie navrhnuté špeciálne pre použitie v kinách a divadlách (verzie "A" pre osvetlenie únikových ciest a koridorov a verzie "B" antipanic osvetlenie pre otvorené priestory)

- **AUTOTEST** funkcia je deaktivovaná, aby sa zamedžilo nežiadúcemu rozsvieteniu LED počas predstavenia

Verzie:

- s **vlastnou batériou** (NO-AT, bez autotestu)
- **CENTRAL BATTERY (C.LEDLUX-SPOT2)** pre **neadresovateľné CBS** (str.44)
- spĺňa požiadavky európskej normy EN 60598-2-22, EN1838, EN62034
- konštrukcia: teleso z plastu vo farbe RAL9005 (čierna)

STANDARD FEATURES

ŠTANDARDNÁ VÝBAVA

- **High efficient HighPower (120lm/W) LONGLIFE LEDs >100.000h**
- **NEW Advanced Electronics**
- **LONGLIFE LiFePo4 battery**
- **Special LED lens** for perfect light distribution
- **Installation Mode** (battery protection, for more details look up page No.51+142)
- **Intelligent battery charging** (intermittent charging, look up page No.51+142)
- **DIP Switch** allowing to preset following functions:
 - **INSTALLATION MODE** activation/deactivation (look up page No.51+142)
 - **Maintained mode** activation/deactivation
- LEDs indicating presence of power supply and signaling failures & TEST button
- **vysoko účinné HighPower LED (120lm/W) so životnosťou min.100000h**
- **progresívna elektronická jednotka**
- **LONGLIFE LiFePo4 batéria**
- špeciálna LED šošovka pre perfektnú distribúciu svetla
- **Inštalacný mód** (ochrana batérie, pozri aj str.51+142)
- **Inteligentné nabíjanie batérie** ("intermittent" nabíjanie, pozri aj str.51+142)
- **DIP prepínač** umožňujúci prednastavenie funkcií:
 - **Inštalacný mód** aktivácia / deaktivácia (pozri aj str.51+142)
 - **trvalé núdzové osvetlenie** aktivácia / deaktivácia
- signalizácia LED a TEST tlačítko

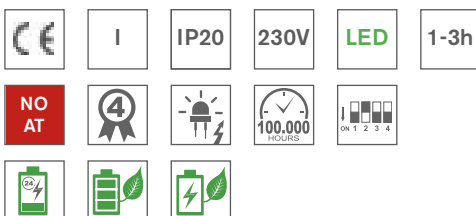

Input Power:

- 5,5W/ 5,7VA (maintained M)
- 1,9W/ 4,0VA (non-maintained NM)
- 3,5W/ 4,6VA (CBS)

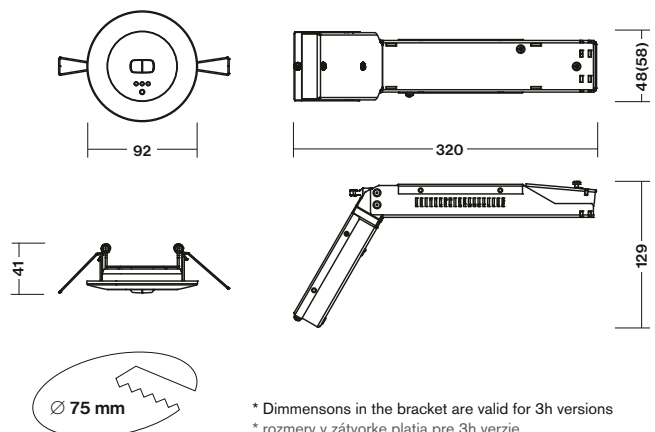

* Dimmensions in the bracket are valid for 3h versions
* rozmery v zátvorke platia pre 3h verzie

NO-AUTOTEST EMERGENCY LIGHTING LEDLUX-SPOT2-V CINEMA

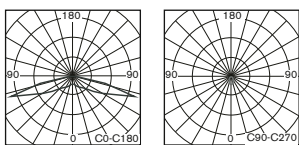
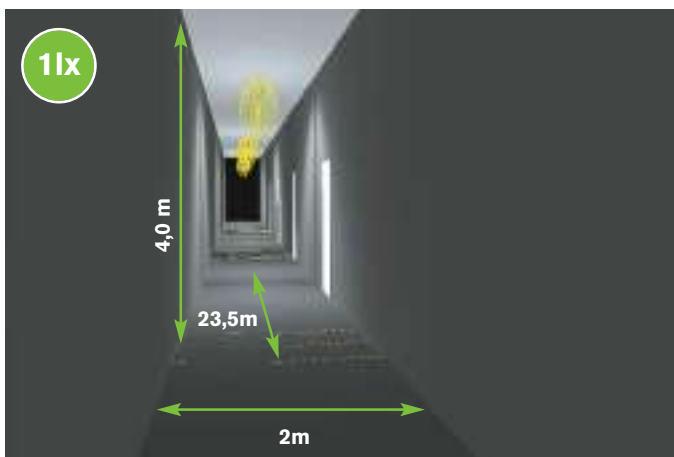

- Escape Route Corridor Application
- All "A" versions
- Osvetlenie únikových ciest
- všetky "A" verzie

1LX SPACING TABLE / ROZMIESTNENIE PRE 1LX		
H (m)	Y1 (m)	Y2 (m)
2,75	8,3	20,1
3,00	8,4	20,9
3,50	7,9	22,5
4,00	7,7	23,5
4,50	7,1	23,1
5,00	6,4	21,9

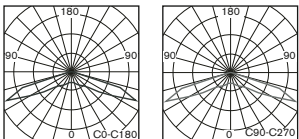
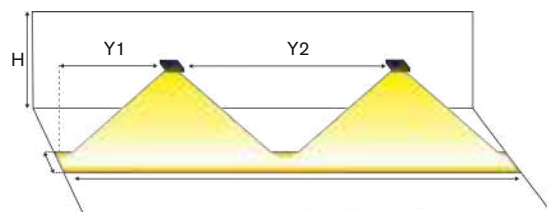

- Antipanic Open Area Application
- All "B" versions
- Antipanic osvetlenie "otvorené" priestory
- všetky "B" verzie

1LX SPACING TABLE / ROZMIESTNENIE PRE 1LX				
H (m)	X1 (m)	X2 (m)	Y1 (m)	Y2 (m)
2,75	3,8	12,6	3,8	12,6
3,00	3,3	12,7	3,3	12,7
3,50	2,5	11,8	2,5	11,8
4,00	1,8	10,1	1,8	10,1

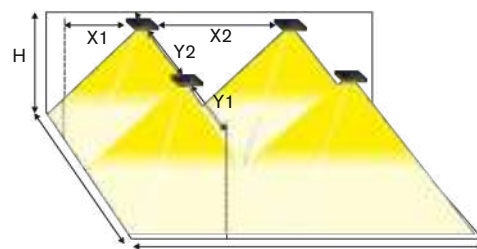

NO-AUTOTEST NM/M

Type	Colour	Light Source	Light Flux / Emergency mode	Battery	Order Code	Weight
MULTILED-SPOT2-A-V.1h NO-AT	Black / čierna	HighPower LED	150 lm / 150 lm	LiFePo4 6,4V/1,0Ah	182-B-328-04-00-03	0,6 kg
MULTILED-SPOT2-B-V.1h NO-AT	Black / čierna	HighPower LED	150 lm / 150 lm	LiFePo4 6,4V/1,0Ah	182-B-329-04-00-03	0,6 kg
MULTILED-SPOT2-A-V.3h NO-AT	Black / čierna	HighPower LED	150 lm / 150 lm	LiFePo4 6,4V/2,0Ah	182-B-331-04-00-03	0,7 kg
MULTILED-SPOT2-B-V.3h NO-AT	Black / čierna	HighPower LED	150 lm / 150 lm	LiFePo4 6,4V/2,0Ah	182-B-332-04-00-03	0,7 kg

Page No.44

CENTRAL BATTERY (CBS)

Type	Colour	Version	Light Source	Light Flux	Order Code	Weight
C.LEDLUX-SPOT2-A-V 230V AC/DC	Black / čierna	CBS NON-ADDRESSABLE	HighPower LED	150 lm	182-B-333-00-00-03	0,5 kg
C.LEDLUX-SPOT2-B-V 230V AC/DC	Black / čierna	CBS NON-ADDRESSABLE	HighPower LED	150 lm	182-B-334-00-00-03	0,5 kg

Look up pages No. 210-217 for 1lx Spacing tables
Pozri str.210-217 pre rozmiestnenie svetidiel na dosiahnutie 1lx

NO-AUTOTEST EMERGENCY LIGHTING FOR SURFACE MOUNTING LEDLUX-SPOT2-P CINEMA



Escape Route Corridor Application "A" version



Open Area Application "B" version

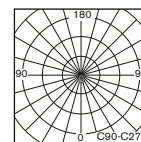
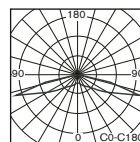

- Escape Route Corridor Application
- All "A" versions
- Osvetlenie únikových ciest
- všetky "A" verzie

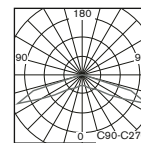
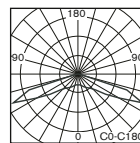

- Antipanic Open Area Application
- All "B" versions
- Antipanic osvetlenie
- všetky "B" verzie

- Modern design orientated **surface mounted LED** non-maintained/maintained (NM/M) emergency lighting especially designed for cinema / theatre applications
- Perfect light distribution **especially** designed for a **corridor applications (all versions "A" - escape route illumination to EN1838) or open area antipanic (all versions "B")**
- **AUTOTEST** function is deactivated to avoid testing (LED ON) during the movie or theatre performance

It is available in all following versions:

- **SELFCONTAINED (NO-AT)**
- **CENTRAL BATTERY (C.LEDLUX-SPOT2)** for **non-addressable CBS** (look up also page No.44)
- Conforming to the requirement of EN60598-2-22, EN1838, EN62034
- Design: plastic body in RAL9005 (black)

- Elegánnté stropné prisadené LED svietidlá pre **netrválé/trvalé (NM/M) núdzové osvetlenie navrhnuté špeciálne pre použitie v kinách a divadlách (verzie "A" pre osvetlenie únikových ciest a koridorov a verzie "B" antipanic osvetlenie pre otvorené priestory)**

- **AUTOTEST** funkcia je deaktivovaná, aby sa zamedžilo nežiadúcemu rozsvieteniu LED počas predstavenia

Verzie:

- s **vlastnou batériou** (NO-AT, bez autotestu)
- **CENTRAL BATTERY (C.LEDLUX-SPOT2)** pre **neadresovateľné CBS** (str.44)
- spĺňa požiadavky európskej normy EN 60598-2-22, EN1838, EN62034
- konštrukcia: teleso z plastu vo farbe RAL9005 (čierna)

STANDARD FEATURES

ŠTANDARDNÁ VÝBAVA

- **High efficient HighPower (120lm/W) LONGLIFE LEDs >100.000h**
- **NEW Advanced Electronics**
- **LONGLIFE LiFePo4 battery**
- **Special LED lens** for perfect light distribution
- **Installation Mode** (battery protection, for more details look up page No.51+142)
- **Intelligent battery charging** (intermittent charging, look up page No.51+142)
- **DIP Switch** allowing to preset following functions:
 - **INSTALLATION MODE** activation/deactivation (look up page No.51+142)
 - **Maintained mode** activation/deactivation
- LEDs indicating presence of power supply and signaling failures & TEST button
- **vysoke účinné HighPower LED (120lm/W) so životnosťou min.100000h**
- **progresívna elektronická jednotka**
- **LONGLIFE LiFePo4 batéria**
- špeciálna LED šošovka pre perfektnú distribúciu svetla
- **Inštalčný mód** (ochrana batérie, pozri aj str.51+142)
- **Inteligentné nabíjanie batérie** ("intermittent" nabíjanie, pozri aj str.51+142)
- **DIP prepínač** umožňujúci prednastavenie funkcií:
 - **Inštalčný mód** aktivácia / deaktivácia (pozri aj str.51+142)
 - trvalé núdzové osvetlenie aktivácia / deaktivácia
- signalizácia LED a TEST tlačítko

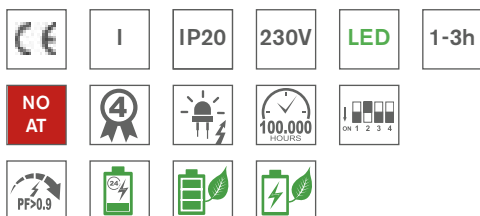

Input Power:

- 5,5W/ 5,7VA (maintained M)
- 1,9W/ 4,0VA (non-maintained NM)
- 3,5W/ 4,6VA (CBS)

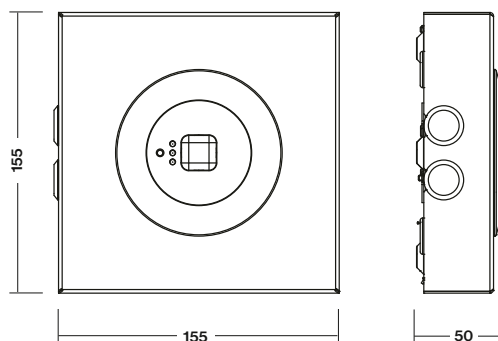

NO-AUTOTEST EMERGENCY LIGHTING FOR SURFACE MOUNTING LEDLUX-SPOT2-P CINEMA

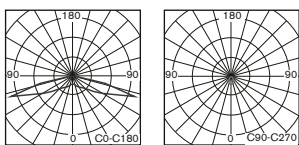
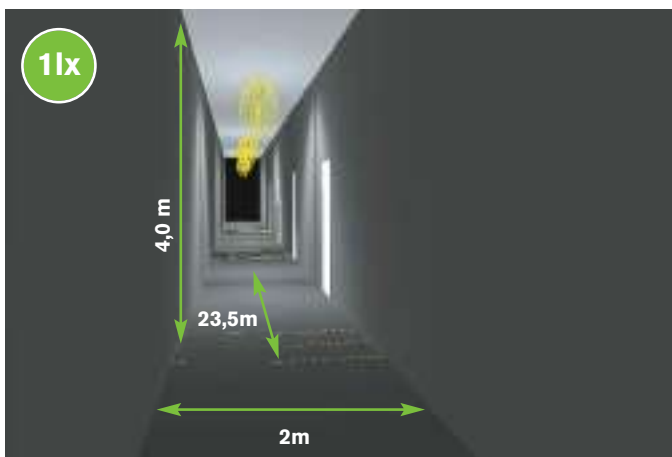

- Escape Route Corridor Application
- All "A" versions
- Osvetlenie únikových ciest
- všetky "A" verzie

1LX SPACING TABLE / ROZMIESTNENIE PRE 1LX		
H (m)	Y1 (m)	Y2 (m)
2,75	8,3	20,1
3,00	8,4	20,9
3,50	7,9	22,5
4,00	7,7	23,5
4,50	7,1	23,1
5,00	6,4	21,9

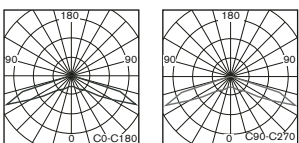
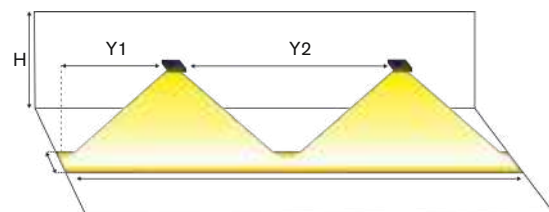

- Antipanic Open Area Application
- All "B" versions
- Antipanic osvetlenie "otvorené" priestory
- všetky "B" verzie

1LX SPACING TABLE / ROZMIESTNENIE PRE 1LX				
H (m)	X1 (m)	X2 (m)	Y1 (m)	Y2 (m)
2,75	3,8	12,6	3,8	12,6
3,00	3,3	12,7	3,3	12,7
3,50	2,5	11,8	2,5	11,8
4,00	1,8	10,1	1,8	10,1

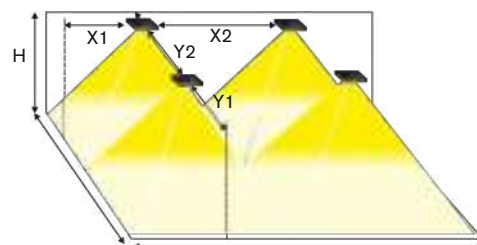

NO-AUTOTEST NM/M

Type	Colour	Light Source	Light Flux / Emergency mode	Battery	Order Code	Weight
MULTILED-SPOT2-A-P.1h NO-AT	Black / čierna	HighPower LED	150 lm / 150 lm	LiFePo4 6,4V/1,0Ah	182-B-233-04-00-03	0,6 kg
MULTILED-SPOT2-B-P.1h NO-AT	Black / čierna	HighPower LED	150 lm / 150 lm	LiFePo4 6,4V/1,0Ah	182-B-234-04-00-03	0,6 kg
MULTILED-SPOT2-A-P.3h NO-AT	Black / čierna	HighPower LED	150 lm / 150 lm	LiFePo4 6,4V/2,0Ah	182-B-235-04-00-03	0,7 kg
MULTILED-SPOT2-B-P.3h NO-AT	Black / čierna	HighPower LED	150 lm / 150 lm	LiFePo4 6,4V/2,0Ah	182-B-236-04-00-03	0,7 kg

Page No.44

CENTRAL BATTERY (CBS)

Type	Colour	Version	Light Source	Light Flux	Order Code	Weight
C.LEDLUX-SPOT2-A-P/230V AC/DC	Black / čierna	CBS NON-ADDRESSABLE	HighPower LED	150 lm	182-B-238-00-00-03	0,5 kg
C.LEDLUX-SPOT2-B-P/230V AC/DC	Black / čierna	CBS NON-ADDRESSABLE	HighPower LED	150 lm	182-B-238-00-00-03	0,5 kg

Look up pages No. 210-217 for 1lx Spacing tables
Pozri str.210-217 pre rozmiestnenie svetidiel na dosiahnutie 1lx

NO-AUTOTEST EMERGENCY LIGHTING FOR HIGH CEILING POWERLUX2 CINEMA

**FOR HIGH CEILING >4m
PRE VYSOKÉ STROPY >4m**



HIGH CEILING >4m

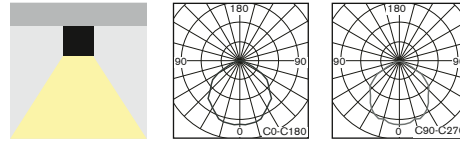

• **POWERFULL** ceiling mounted LED fixture available for all non-maintained (NM), maintained (M) or centralised (C) emergency lighting especially designed for **HIGH CEILING applications such as CINEMA/THEATRE applications where AT function is not required (disturbing)**

• **AUTOTEST** function is deactivated to avoid testing (LED ON) during the movie or theatre performance

It is available in all following versions:

- **SELFCONTAINED (NO-AT)**
- **CENTRAL BATTERY (C.POWERLUX2)** for **non-addressable CBS** (look up also page No.44)

• Conforming to the requirement of EN60598-2-22, EN1838, EN62034

• Design:

- metal sheet body with powder coat finish RAL9005 (black)
- impact resistant polycarbonate diffuser (PC)

• **NOVÝ typ** výkonného LED svietidla pre **netrvalé (NM), trvalé (M)** alebo **centrálne (C)** núdzové osvetlenie pre povrchovú montáž **špeciálne navrhnuté pre aplikácie vo veľkých výškach v kinách/divadlách alebo všade tam, kde nie je autotest funkcia žiadúca**

• **AUTOTEST** funkcia je deaktivovaná, aby sa zamedžilo nežiadúcemu rozsvieteniu LED počas predstavenia

Verzie:

- **s vlastnou batériou** (NO-AT, bez autotestu)
- **CENTRAL BATTERY (C.POWERLUX2)** pre **neadresovateľné CBS** (str.44)
- spĺňa požiadavky európskej normy EN 60598-2-22, EN1838, EN62034
- konštrukcia:
 - teleso z plechu vo farbe RAL9005 (čierna)
 - svetelno-činný kryt z nerozbitného polykarbonátu

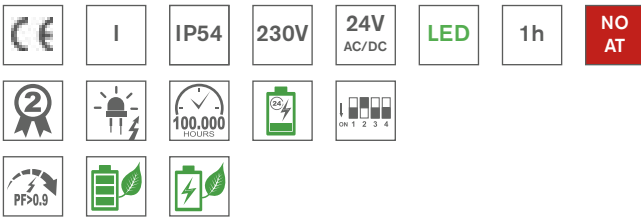

Input Power:

- 17W/ 19VA (maintained M)
- 4,0W/ 5,0VA (non-maintained NM)
- 33W/ 36VA (CBS)

**MULTIPOWER2-AT 1h (1650lm)
1LX SPACING TABLE**

H (m)	X1 (m)	X2 (m)	Y1 (m)	Y2 (m)
4,0	7,9	18,2	7,9	18,2
5,0	9,0	20,8	9,0	20,8
6,0	9,7	23,3	9,7	23,3
7,0	10,4	25,4	10,4	25,4
8,0	11,0	27,1	11,0	27,1
9,0	11,4	28,3	11,4	28,3
10,0	11,5	29,8	11,5	29,8
11,0	11,6	31,0	11,6	31,0
12,0	11,6	31,7	11,6	31,7
13,0	11,5	32,2	11,5	32,2
14,0	11,2	32,6	11,2	32,6
15,0	11,0	32,7	11,0	32,7
16,0	10,8	32,8	10,8	32,8
17,0	10,1	32,6	10,1	32,6
18,0	9,5	32,5	9,5	32,5
19,0	8,8	32,1	8,8	32,1
20,0	8,1	31,8	8,1	31,8

**C.POWERLUX2 (3900lm)
1LX SPACING TABLE**

H (m)	X1 (m)	X2 (m)	Y1 (m)	Y2 (m)
4,0	9,0	20,0	9,0	20,0
5,0	10,5	23,2	10,5	23,2
6,0	11,8	26,3	11,8	26,3
7,0	13,0	28,9	13,0	28,9
8,0	14,0	31,6	14,0	31,6
9,0	14,7	34,0	14,7	34,0
10,0	15,5	35,8	15,5	35,8
11,0	15,8	37,7	15,8	37,7
12,0	16,3	39,3	16,3	39,3
13,0	16,7	40,5	16,7	40,5
14,0	16,8	41,3	16,8	41,3
15,0	17,0	42,0	17,0	42,0
16,0	17,3	42,8	17,3	42,8
17,0	17,3	43,4	17,3	43,4
18,0	17,3	43,7	17,3	43,7
19,0	17,3	44,3	17,3	44,3
20,0	17,0	44,5	17,0	44,5

STANDARD FEATURES

ŠTANDARDNÁ VÝBAVA

- **High efficient MidPower (150lm/W) LONGLIFE LEDs (>100.000h) 5000K**
- **NEW Advanced Electronics**
- **LONGLIFE LiFePo4 battery**
- **Installation Mode** (battery protection, for more details look up page No.51)
- **Intelligent battery charging** (intermittent charging, look up page No.51)
- **Jumper** allowing to preset following functions:
 - **INSTALLATION MODE** activation/deactivation (look up page No.51)
 - **Maintained mode** activation/deactivation
- LEDs indicating presence of power supply and signaling failures & TEST button
- **vysoko účinné MidPower LED (150lm/W)** so životnosťou min.100000h (5000K)
- **progresívna elektronická jednotka**
- **LONGLIFE LiFePo4 batéria**
- **Inštaláčny mód** (ochrana batérie, pozri aj str.51)
- **Inteligentné nabíjanie batérie** ("intermittent" nabíjanie, pozri aj str.51)
- **Jumper** umožňujúci prednastavenie funkcií:
 - **Instalačný mód** aktivácia / deaktivácia (pozri aj str.51)
 - **trvalé núdzové osvetlenie** aktivácia / deaktivácia
- signalizácia LED a TEST tlačítko

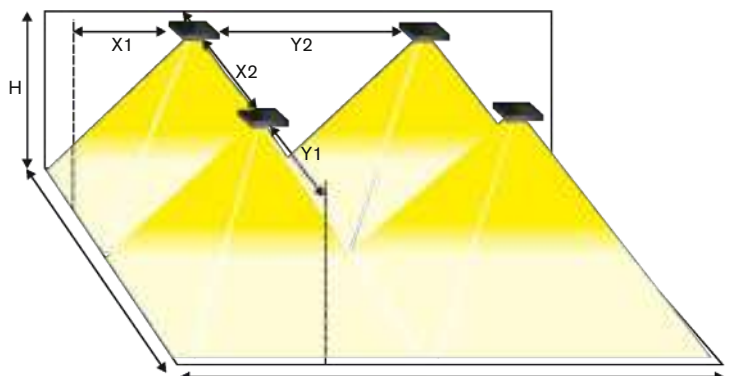

NO-AUTOTEST EMERGENCY LIGHTING FOR HIGH CEILING POWERLUX2 CINEMA

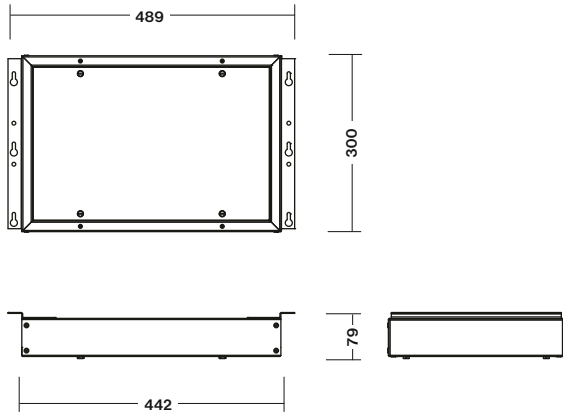

Light source	LED 5000K
LED Light output	1650lm / 3900lm
Housing colour	RAL9005 Black
Application	High Ceiling
	Anti-panic lighting
Max room illumination	up to 1520m² > 0.5lx
(valid for C.POWERLUX2 CBS version)	

NO-AUTOTEST NM/M

Type	Colour	Light Source	Light Flux / Emergency mode	Battery	Order Code	Weight
MULTIPOWER2.1h RAL9005 NO-AT	Black / čierna	MidPower LEDs	1650 lm / 1650 lm	LiFePo4 6,4V/4,5Ah	15-B-108-04-00-03	5,7 kg

Page No.44

CENTRAL BATTERY (CBS)

Type	Colour	Version	Light Source	Light Flux	Order Code	Weight
C.POWERUX2 230V AC/DC RAL9005	Black / čierna	CBS NON-ADDRESSABLE	MidPower LEDs	3900 lm	15-B-102-00-00-03	4,5 kg
C.POWERUX2 24V AC/DC RAL9005	Black / čierna	CBS NON-ADDRESSABLE	MidPower LEDs	1650 lm	15-B-103-00-00-03	4,5 kg



Product
Assortment

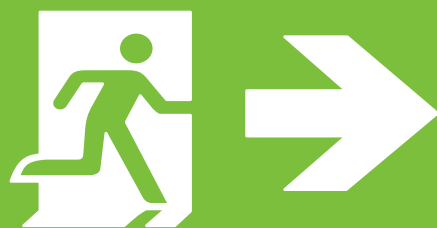

EMERGENCY
LIGHTING

NÚDZOVÉ
SVIETIDLÁ

STANDARD Line (Page No: 182-209)

LED TUBE FOR 8W FLUO-TUBE RETROFIT



Popis

- navrhnuté pre výmenu klasickej žiarivky 8W v núdzových svietidlách SEC (platí len pre verzie AT, ATXL)
- možné použiť aj pre staršie už namontované SEC AT/ATXL 8W núdzové svietidlá alebo pre rovnaké nové počas ich prvomontáže
- nie je nutná žiadna zmena v elektronike alebo zapojení svietidla
- životnosť až 100.000 hod
- vysoká účinnosť LED až 156 lm/W
- svetelný tok +25% v porovnaní s 8W žiarivkou v núdzovom režime
- profesionálny dizajn elektro časti a chladiča
- znižuje emisie CO₂
- znižuje servisné náklady na výmenu svetelných zdrojov

SEC LED LongLife tube je progresívny vymeniteľný LED svetelný zdroj vyvinutý firmou SEC pre jednoduchý upgrade 8W žiarivkových núdzových svietidiel SEC na LED technológiu so životnosťou až 100000 hod. MiniLED má integrovaný chladič a využíva tie isté elektronické obvody už zabudované vo svietidlách SEC typu AT alebo ATXL, takže nie je potrebná zmena elektroniky svietidla a ani jeho kabeláže.

Použitie

SEC LED LongLife tube je špeciálne určený pre všetky SEC 8W svietidlá pre trvalé núdzové osvetlenie, ktoré sú v prevádzke non-stop 24/7. Autonómnosť svietidla ostáva nezmenená, ale výkon svietidla s LED LongLife tube sa zvýši o +25% v porovnaní s pôvodnou 8W žiarivkou. Môže byť použitý či už v namontovaných svietidlách SEC 8W AT/ATXL alebo v takýchto nových svietidlách počas ich prvomontáže. Päťice ostávajú bez zmeny typu G5. Keďže SEC LED LongLife tube je jednoducho vymeniteľný svetelný zdroj ako klasická žiarivka, užívateľ môže jednoducho modernizovať svoje núdzové svietidlá v budúcnosti aj na novšie LED trubice SEC bez nutnosti výmeny samotného svietidla.

Elektronika

SEC LED LongLife tube je možné použiť len vo svietidlách SEC typu AT alebo ATXL. Nie je použiteľný v žiadnom inom svietidle.

Technické informácie

SEC LED LongLife tube obsahuje 18ks LED s účinnosťou až 156 lm/W a celkovým svetelným tokom až 240lm v núdzovom režime, čo je výrazne viac ako výkon 8W žiarivky počas núdzového režimu.

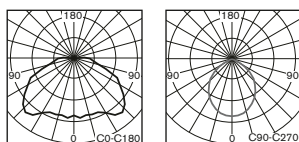

Description

- Designed for retrofit of standard 8W fluorescent tube in SEC emergency luminaires (valid for all SEC AT, ATXL versions only)
- Suitable for either old SEC AT/ATXL 8W emergency lighting fixtures or for currently produced ones
- Neither new electronics nor rewiring is needed
- Upto 100.000h lifetime comparing 6000h for traditional 8W tube
- LED High Efficiency up to 156lm/W
- Light output +25% comparing to 8W fluorescent tube during emergency mode
- Excellent thermal and electrical design
- Reduces CO₂ emissions
- Reduces both service and maintenance costs SEC LED tube

Applications

SEC LED LongLife tube is especially designed for all maintained 8W SEC emergency lighting fixtures which operates non-stop 24/7. The emergency lighting duration remains unchanged but LED tube ensures +25% higher light output comparing original 8W fluorescent tube version. You can use it either for an older already installed 8W AT or ATXL lighting fixtures or for a new ones during the first installation. LED LongLife tube is designed for standard G5 sockets. As the LED light tube is as easy to replace as a regular fluorescent tube, customers can easily upgrade to even more efficient SEC LED tube in the future without having to change the entire luminaire. It is smart maintenance cost reduction with a lifetime upto 100.000h comparing 6000h for traditional 8W fluorescent tube.

Electronics

SEC LED LongLife tube must be used just in SEC emergency lighting fixtures version AT or ATXL. It is not compatible with any other electronics.

Technical information

SEC LED LongLife tube is equipped with 18pcs of LEDs with high efficiency, up to 156 lm/W and luminous flux during emergency mode up to 240 lm what is even higher than 8W fluorescent tube light output.

LED LongLife Light Tube

Diffuser Version / kryt trubice	Diffuser white milky PC / opálové PC
Heat Sink / chladič	Aluminum
Light Colour / farba svetla	5000K
8W Tube Compatibility/ kompatibilita	100%
Cap / pre päťicu	G5
Normal operation mode light output	290 lm
Emergency mode light output	240 lm
Efficiency / účinnosť	156 lm/W
Order Code / objednávaci kód	18-B-01

WALL OR CEILING MOUNTING PICTORLUX



← 26m/8W
→ 28m/LED

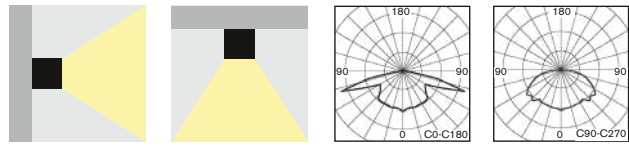

• Solid design surface mounted powerful fixture with perfect light distribution for non-maintained (NM), non-maintained/maintained (NM/M) or centralised (C) emergency lighting available in all following versions:

- **AUTOTEST** (-AT)
- **CENTRAL BATTERY** (C.PICTORLUX) for **non-addressable CBS** (look up also page No.44)
- Conforming to the requirement of EN60598-2-22, EN1838, EN62034
- Design: PC impact resistant body

• kompaktné a elegantné výkonné núdzové svietidlo s perfektnou distribúciou svetla pre netrvané (NM) alebo pre trvalé/netrvané (NM/M) alebo (C) centrálné napájané núdzové osvetlenie dostupné vo verziách pre:

- **AUTOTEST** (-AT)
- **CENTRAL BATTERY** (C.PICTORLUX) pre **neadresovateľné CBS** (pozri str. 44)
- spĺňa požiadavky európskej normy EN 60598-2-22, EN1838, EN62034
- konštrukcia: teleso z nerozbitného PC

STANDARD FEATURES

ŠTANDARDNÁ VÝBAVA

- **HighPower LEDs 120lm/W, 5000K with the life time >100.000h** (valid for LED versions only)
- Set of self-adhesive legends (H+I+J)
- LEDs indicating both presence of power supply and signaling failures
- TEST button

- **výkonné LED 120lm/W (5000K) so životnosťou min 100000hod** (platí len pre LED verzie)
- sada samolepiacich piktogramov H+I+J
- signalizácia LED a TEST tlačítko



OPTIONAL ACCESSORIES

PRÍPLATKY

- Suspended plexi with single sided or double sided legend (look up page No.185)
- Wall or ceiling mounting brackets
- Protective steel cage
- závesné plexi s jednostranným alebo obojstranným piktogramom (pozri str.185)
- nástenná, stropná alebo stropná závesná konzola
- ochranný kovový kôš

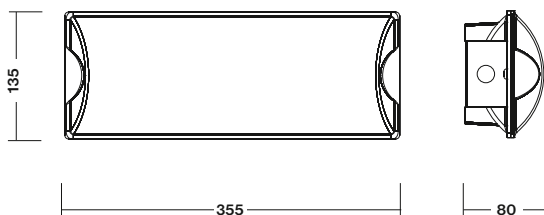
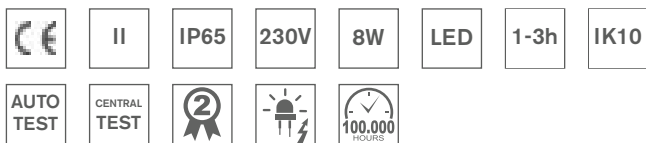

Optional Item / Príplatok	Order Code / objednávaci kód
Wall mounting bracket / nástenná konzola	259-B-18-00
Ceiling mounting bracket / stropná konzola	259-B-18-01
Pendant bracket 0,5m / závesná konzola 0,5m	259-B-18-02
Pendant bracket 1,0m / závesná konzola 1,0m	259-B-18-03
Protective steel cage / ochranný kôš	259-B-00-02



Optional Suspended plexi with Legends
Príplatkové závesné plexi s piktogramom
(Look up also page No.185)



Optional Brackets and Protective Steel Cage
Príplatkové konzoly a ochranná mreža

- Suspended plexi with single or double sided legend
 - Viewing Distance 32m/35m
- závesné plexi s jednostranným alebo obojstranným piktogramom
 - rozoznatelnosť piktogramu 32m/35m



Optional Item / Príplatok	Order Code / Objednávaci kód
Suspended plexi H/J doublesided / obojstranné	259-B-19-06
Suspended plexi I doublesided / obojstranné	259-B-19-07
Suspended plexi I singlesided / jednostranné	259-B-19-09
Suspended plexi H singlesided / jednostranné	259-B-19-03
Suspended plexi J singlesided / jednostranné	259-B-19-04



								NM/M
Type	Version	Duration	Light Source	Light Flux / Emergency mode	Battery	Order Code	Weight	
PICTORLUX 8W.1h	NM	1h	8W / G5	- / 131 lm	NiCd 3,6V/1,8Ah	259-B-00-03-00	1,2 kg	
MULTIPICTOR 3xLED.1h	NM/M	1h	3x HighPower LED	280 lm / 230 lm	NiMh 4,8V/2,1Ah	259-B-10	1,3 kg	
MULTIPICTOR 8xLED.3h	NM/M	3h	8x Low Power LED	60 lm / 60 lm **	NiMh 4,8V/0,85Ah	259-B-24-02-00-00	1,2 kg	

Page No.32

AUTOTEST -AT NM/M

Type	Version	Duration	Light Source	Light Flux / Emergency mode	Battery	Order Code	Weight
MULTIPICTOR-AT 12xLED.1h **	NM/M	1h	12x Low Power LED	90 lm / 90 lm **	NiMh 4,8V/0,85Ah	259-B-25-02-00-00	1,3 kg
MULTIPICTOR-AT 12xLED.3h **	NM/M	3h	12x Low Power LED	90 lm / 90 lm **	NiMh 4,8V/2,1Ah	259-B-26-02-00-00	1,4 kg
MULTIPICTOR-AT 8W.1h	NM/M	1h	8W / G5	410 lm / 205 lm	NiMh 4,8V/2,1Ah	259-B-04-03-00	1,3 kg
MULTIPICTOR-AT 5xLED.1h	NM/M	1h	5x HighPower LED	470 lm / 366 lm	NiMh 4,8V/4,0Ah	259-B-13-03-00	1,4 kg

Page No.44

CENTRAL BATTERY (CBS)

Type	Version	Light Source	Light Flux	Order Code	Weight
C.PICTORLUX 12xLED/230V AC/DC **	CBS NON-ADDRESSABLE	12x Low Power LED	90 lm **	259-B-27-00-00-00	1,0 kg
C.PICTORLUX 8W/230V AC/DC	CBS NON-ADDRESSABLE	8W / G5	410 lm	259-B-09-02-00	1,0 kg
C.PICTORLUX 5xLED/230V AC/DC	CBS NON-ADDRESSABLE	5x HighPower LED	470 lm	259-B-16-02-00	1,1 kg

Look up pages No. 210-217 for 1x Spacing tables
Pozri str.210-217 pre rozmiestnenie svietidiel na dosiahnutie 1x

** Especially suitable for emergency sign illumination / applications
** Vhodné najmä pre aplikácie, kde je na svietidle piktogram

WALL OR CEILING MOUNTING LEDLUX-P



← → 26m



← → 26m



← → 26m

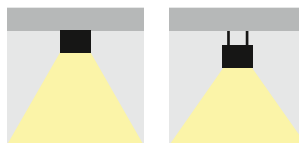

- Modern design **surface mounted LED** non-maintained (NM), maintained (M) or centralised (C) emergency lighting with smooth legend illumination for all **areas such as offices, shops, hotels, banks, entrance halls, schools, hospitals, etc.**

It is available in all following versions:

- **AUTOTEST** (-AT)
- **CENTRAL BATTERY** (C.LEDLUX) for **non-addressable CBS** (look up also page No.44)
- Conforming to the requirement of EN60598-2-22, EN1838, EN62034
- Design: metal sheet body with PE powder coat finish RAL9006 (grey) or RAL9003 (white) or RAL9005 (black)
- stropné moderné LED svietidlo pre **netrvalé (NM), trvalé (M) alebo centrálne (C)** núdzové osvetlenie s perfektnou rovnomernosťou osvetlenia piktogramu navrhnuté pre všeobecné použitie priestorov ako napr. kancelárie, obchody, školy, nemocnice, vstupné haly, banky a pod., aj s funkciami:
 - **AUTOTEST** (-AT)
 - **CENTRAL BATTERY** (C.LEDLUX) pre **neadresovateľné CBS** (pozri str.44)
- spĺňa požiadavky európskej normy EN 60598-2-22, EN1838, EN62034
- konštrukcia: teleso z ocelového plechu vo farbe RAL9006 (šedá) alebo RAL9003 (biela) alebo RAL9005 (čierna)

STANDARD FEATURES

- LEDs indicating both presence of power supply and signaling failures
- TEST button
- signalizácia LED a TEST tlačítko

ŠTANDARDNÁ VÝBAVA

OPTIONAL ACCESSORIES

- **Special suspended plexi with layered design for perfect smooth illumination of legend. It must be ordered as a separate item- look up page No.188**
- Wall or ceiling mounting brackets (look up page No.189)
- Wire rope suspension set (look up page No.189)
- Alternative colour surface treatment in RAL (min order quantity 100pcs)
- **špeciálne vrstvené závesné plexi pre rovnomerné osvetlenie piktogramu na jeho celej ploche (plexi musí byť objednané samostatne podľa želaného piktogramu- viď strana 188 pre detaily)**
- nástenná, stropná alebo stropná závesná konzola (pozri str. 189)
- lanková závesná sada (pozri str. 189)
- povrchová úprava vo farbe podľa špecifikácie odberateľa (min 100ks)

PRÍPLATKY



Optional Brackets (refer to page No.189)
Príplatkové konzoly (pozri str. 189)

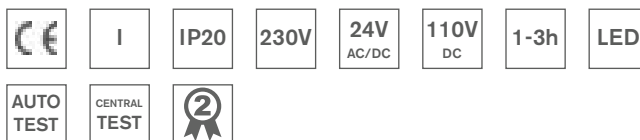

Input Power:

- 3,9W / 7,4VA (maintained M)
- 2,6W / 5,8VA (non-maintained NM)
- 1,3W / 4,0VA (CBS)

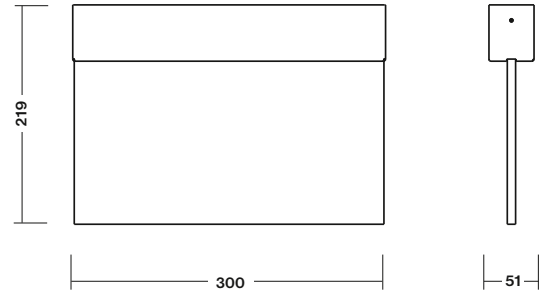

NM/M							
Type	Version	Colour	Light Source	Duration	Battery	Order Code	Weight
MULTILED-P 3h RAL9006	Only Body, No Plexi incl.	Grey / šedá	8x LED	3h	NiMh 4,8V/0,85Ah	85-B-103-05-00	1,2 kg
MULTILED-P 3h RAL9003	Only Body, No Plexi incl.	White / biela	8x LED	3h	NiMh 4,8V/0,85Ah	85-B-103-06-00	1,2 kg
MULTILED-P 3h RAL9005	Only Body, No Plexi incl.	Black / čierna	8x LED	3h	NiMh 4,8V/0,85Ah	85-B-05-07-02	1,2 kg

Page No.32 AUTOTEST -AT NM/M							
Type	Version	Colour	Light Source	Duration	Battery	Order Code	Weight
MULTILED-P-AT 1h RAL9006	Only Body, No Plexi incl.	Grey / šedá	12x LED	1h	NiMh 4,8V/0,85Ah	85-B-111-05-00	1,2 kg
MULTILED-P-AT 1h RAL9003	Only Body, No Plexi incl.	White / biela	12x LED	1h	NiMh 4,8V/0,85Ah	85-B-111-06-00	1,2 kg
MULTILED-P-AT 1h RAL9005	Only Body, No Plexi incl.	Black / čierna	12x LED	1h	NiMh 4,8V/0,85Ah	85-B-111-10-03	1,2 kg
MULTILED-P-AT 3h RAL9006	Only Body, No Plexi incl.	Grey / šedá	12x LED	3h	NiMh 4,8V/2,1Ah	85-B-108-05-00	1,3 kg
MULTILED-P-AT 3h RAL9003	Only Body, No Plexi incl.	White / biela	12x LED	3h	NiMh 4,8V/2,1Ah	85-B-108-06-00	1,3 kg

Page No.44 CENTRAL BATTERY (CBS)							
Type	Version	Colour	CBS Version for	Light Source	Order Code	Weight	
C.LEDLUX-P 230V AC/DC RAL9006	Only Body, No Plexi incl.	Grey / šedá	CBS NON-ADDRESSABLE	12x LED	85-B-13-13-00	1,0 kg	
C.LEDLUX-P 230V AC/DC RAL9003	Only Body, No Plexi incl.	White / biela	CBS NON-ADDRESSABLE	12x LED	85-B-13-14-01	1,0 kg	
C.LEDLUX-P 230V AC/DC RAL9005	Only Body, No Plexi incl.	Black / čierna	CBS NON-ADDRESSABLE	12x LED	85-B-13-06-02	1,0 kg	
C.LEDLUX-P 24V AC/DC RAL9006	Only Body, No Plexi incl.	Grey / šedá	CBS NON-ADDRESSABLE	12x LED	85-B-07-10-00	1,0 kg	
C.LEDLUX-P 24V AC/DC RAL9003	Only Body, No Plexi incl.	White / biela	CBS NON-ADDRESSABLE	12x LED	85-B-07-11-00	1,0 kg	

ACCESSORIES LEDLUX-P



• It is not included in standard package. It must be ordered as separate item !

• Viewing Distance 26m for all H,I,J,K,L,M,N versions in accordance with ISO7010

• nie je súčasťou štandardného balenia svietidla, musí byť objednané ako samostatná položka !

• rozoznatelnosť piktogramu 26m pre všetky H,I,J,K,L,M,N verzie v súlade s ISO7010



OPTIONAL ITEM	ORDER CODE
Double sided plexi H/J	85-B-312-23-01
Double sided plexi I	85-B-312-21-01
Single sided plexi H	85-B-312-29-01
Single sided plexi I	85-B-312-20-01
Single sided plexi J	85-B-312-30-01
Double sided plexi K/M	85-B-19-40-01
Double sided plexi L/N	85-B-19-41-01
Single sided plexi K	85-B-19-46-01
Single sided plexi L	85-B-19-47-01
Single sided plexi M	85-B-19-48-01
Single sided plexi N	85-B-19-49-01
Double sided plexi Z1	309-B-000-00-00-27
Double sided plexi Z2	309-B-000-00-00-28

PRIPLATOK	OBJEDNÁVACÍ KÓD
Obojstranné plexi H/J	85-B-312-23-01
Obojstranné plexi I	85-B-312-21-01
Jednostranné plexi H	85-B-312-29-01
Jednostranné plexi I	85-B-312-20-01
Jednostranné plexi J	85-B-312-30-01
Obojstranné plexi K/M	85-B-19-40-01
Obojstranné plexi L/N	85-B-19-41-01
Jednostranné plexi K	85-B-19-46-01
Jednostranné plexi L	85-B-19-47-01
Jednostranné plexi M	85-B-19-48-01
Jednostranné plexi N	85-B-19-49-01
Obojstranné plexi Z1	309-B-000-00-00-27
Obojstranné plexi Z2	309-B-000-00-00-28





- Optional Accessories:**
- Wall brackets
 - Wire rope suspension set

Príplatky:

- nástenné konzoly
- lankový záves

Parallel wall mounting bracket
Konzola rovnobežne so stenou



Upright wall mounting bracket
Konzola kolmo na stenu



Optional Item / Príplatky	Order Code
Parallel wall mounting bracket in white RAL9003 colour / nástenná konzola rovnobežne so stenou v bielej RAL9003	85-B-05-08-00
Parallel wall mounting bracket in grey RAL9006 colour / nástenná konzola rovnobežne so stenou v šedej RAL9006	85-B-05-08-F17
Parallel wall mounting bracket in black RAL9005 colour / nástenná konzola rovnobežne so stenou v čiernej RAL9005	85-B-05-08-01
Upright wall mounting bracket in white RAL9003 colour / konzola kolmo na stenu v bielej RAL9003	85-B-05-09-00
Upright wall mounting bracket in grey RAL9006 colour / konzola kolmo na stenu v šedej RAL9006	85-B-05-09-F17
Upright wall mounting bracket in čiernej RAL9005 colour / konzola kolmo na stenu v čiernej RAL9005	85-B-05-09-01
Wire rope suspension set 1,0m long in white RAL9003 colour / lanková závesná sada 1,0m dlhá v bielej RAL9003 farbe	85-B-05-13-01
Wire rope suspension set 1,0m long in grey RAL9006 colour / lanková závesná sada 1,0m dlhá v šedej RAL9006 farbe	85-B-05-13-00
Wire rope suspension set 1,5m long in white RAL9003 colour / lanková závesná sada 1,5m dlhá v bielej RAL9003 farbe	85-B-05-25-F1
Wire rope suspension set 1,5m long in grey RAL9006 colour / lanková závesná sada 1,5m dlhá v šedej RAL9006 farbe	85-B-05-25-00
Wire rope suspension set 2,0m long in white RAL9003 colour / lanková závesná sada 2,0m dlhá v bielej RAL9003 farbe	85-B-05-60-00
Wire rope suspension set 2,0m long in grey RAL9006 colour / lanková závesná sada 2,0m dlhá v šedej RAL9006 farbe	85-B-05-18-00
Wire rope suspension set 3,5m long in white RAL9003 colour / lanková závesná sada 3,5m dlhá v bielej RAL9003 farbe	85-B-05-26-F1
Wire rope suspension set 3,5m long in grey RAL9006 colour / lanková závesná sada 3,5m dlhá v šedej RAL9006 farbe	85-B-05-26-00
Pendant ceiling mounting bracket 1,0m in white RAL9003 colour / trubková závesná sada 1,0m dlhá v bielej RAL9003 farbe	85-B-05-27-F1
Pendant ceiling mounting bracket 1,0m in grey RAL9006 colour / trubková závesná sada 1,0m dlhá v šedej RAL9006 farbe	85-B-05-27-F17



CEILING MOUNTING
LEDLUX-P



CEILING MOUNTING
LEDLUX-P



RECESSED MOUNTING LEDLUX-V



- Modern design **recessed LED** non-maintained (NM), maintained (M) or centralised (C) emergency lighting with smooth legend illumination for all **areas such as offices, shops, hotels, banks, entrance halls, schools, hospitals, etc.**

It is available in all following versions:

- **AUTOTEST** (-AT)
- **CENTRAL BATTERY** (C.LEDLUX) for **non-addressable CBS** (look up also page No.44)
- Conforming to the requirement of EN60598-2-22, EN1838, EN62034
- Design:
 - metal sheet body with PE powder coat finish RAL9006 (grey) or RAL9003 (white) or RAL9005 (čierna)
 - Special suspended plexi with layered design for perfect smooth illumination of a legend. It must be ordered as a separate item- look up the page No.194
- moderné stropné zapustené LED svietidlo pre **netrvalé (NM), trvalé (M) alebo centrálne (C)** núdzové osvetlenie s perfektnou rovnomernosťou osvetlenia piktogramu navrhnuté pre všeobecné použitie priestorov ako napr. kancelárie, obchody, školy, nemocnice, vstupné haly, banky a pod., aj s funkciami:
 - **AUTOTEST** (-AT)
 - **CENTRAL BATTERY** (C.LEDLUX) pre **neadresovateľné CBS** (pozri str.14)
 - spĺňa požiadavky európskej normy EN 60598-2-22, EN1838, EN62034
 - konštrukcia:
 - teleso z oceleového plechu vo farbe RAL9006 (šedá) alebo RAL9003 (biela) alebo RAL9005 (čierna)
 - špeciálne vrstvené závesné plexi pre rovnomerné osvetlenie piktogramu na jeho celej ploche (musí byť objednané ako samostatná položka - pozri str. 194)



← → 26m



← → 26m



← → 26m

STANDARD FEATURES

- LEDs indicating both presence of power supply and signaling failures
- TEST button
- signalizácia LED
- TEST tlačítko

STANDARDNÁ VÝBAVA

OPTIONAL ACCESSORIES

- **Special suspended plexi with layered design for perfect smooth illumination of legend. It must be ordered as a separate item- look up the page No.194**
- Alternative colour surface treatment in RAL (min order quantity 100pcs)
- **špeciálne vrstvené závesné plexi pre rovnomerné osvetlenie piktogramu na jeho celej ploche (plexi musí byť objednané samostatne podľa želaného piktogramu- viď strana 194 pre detaily)**
- povrchová úprava vo farbe podľa špecifikácie odberateľa (min 100ks)

PRÍPLATKY

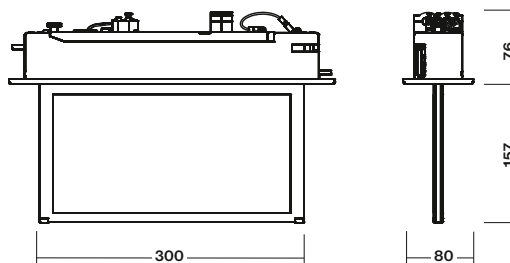

Recessed mounting hole size: 336 x 57 mm
Rozmer montážneho otvoru : 336 x 57 mm

Input Power:

- 3,9W / 7,4VA (maintained M)
- 2,6W / 5,8VA (non-maintained NM)
- 1,3W / 4,0VA (CBS)



NM/M

Type	Version	Colour	Light Source	Duration	Battery	Order Code	Weight
MULTILED-V 3h RAL9006	Only Body, No Plexi incl.	Grey / šedá	8x LED	3h	NiMh 4,8V/0,85Ah	85-B-100-05-00	1,2 kg
MULTILED-V 3h RAL9003	Only Body, No Plexi incl.	White / biela	8x LED	3h	NiMh 4,8V/0,85Ah	85-B-100-06-00	1,2 kg
MULTILED-V 3h RAL9005	Only Body, No Plexi incl.	Black / čierna	8x LED	3h	NiMh 4,8V/0,85Ah	85-B-100-07-00	1,2 kg

Page No.32

AUTOTEST -AT NM/M

Type	Version	Colour	Light Source	Duration	Battery	Order Code	Weight
MULTILED-V-AT 1h RAL9006	Only Body, No Plexi incl.	Grey / šedá	12x LED	1h	NiMh 4,8V/0,85Ah	85-B-101-05-00	1,2 kg
MULTILED-V-AT 1h RAL9003	Only Body, No Plexi incl.	White / biela	12x LED	1h	NiMh 4,8V/0,85Ah	85-B-101-10-01	1,2 kg
MULTILED-V-AT 3h RAL9006	Only Body, No Plexi incl.	Grey / šedá	12x LED	3h	NiMh 4,8V/2,1Ah	85-B-102-05-00	1,3 kg
MULTILED-V-AT 3h RAL9003	Only Body, No Plexi incl.	White / biela	12x LED	3h	NiMh 4,8V/2,1Ah	85-B-102-04-00	1,3 kg

Page No.44

CENTRAL BATTERY (CBS)

Type	Version	Colour	CBS Version for	Light Source	Order Code	Weight
C.LEDLUX-V 230V AC/DC RAL9006	Only Body, No Plexi incl.	Grey / šedá	CBS NON-ADDRESSABLE	12x LED	85-B-104-05-00	1,0 kg
C.LEDLUX-V 230V AC/DC RAL9003	Only Body, No Plexi incl.	White / biela	CBS NON-ADDRESSABLE	12x LED	85-B-104-06-00	1,0 kg
C.LEDLUX-V 230V AC/DC RAL9005	Only Body, No Plexi incl.	Black / čierna	CBS NON-ADDRESSABLE	12x LED	85-B-104-05-02	1,0 kg
C.LEDLUX-V 24V AC/DC RAL9006	Only Body, No Plexi incl.	Grey / šedá	CBS NON-ADDRESSABLE	12x LED	85-B-114-05-00	1,0 kg
C.LEDLUX-V 24V AC/DC RAL9003	Only Body, No Plexi incl.	White / biela	CBS NON-ADDRESSABLE	12x LED	85-B-114-06-00	1,0 kg

ACCESSORIES LEDLUX-V

• It is not included in standard package. It must be ordered as separate item !

• nie je súčasťou štandardného balenia svietidla, musí byť objednané ako samostatná položka !



- Viewing Distance 26m for all H,I,J,K,L,M,N versions in accordance with ISO7010
- rozoznatelnosť piktogramu 26m pre všetky H,I,J,K,L,M,N v súlade s ISO7010

OPTIONAL ITEM / PRÍPLATOK	Order Code / Objednávaci kód
Double sided plexi H/J, obojstranné plexi H/J	85-B-312-23-01
Double sided plexi I, obojstranné plexi I	85-B-312-21-01
Single sided plexi H, jednostranné plexi H	85-B-312-29-01
Single sided plexi I, jednostranné plexi I	85-B-312-20-01
Single sided plexi J, jednostranné plexi J	85-B-312-30-01
Double sided plexi K/M, obojstranné plexi K/M	85-B-19-40-01
Double sided plexi L/N, obojstranné plexi L/N	85-B-19-41-01
Single sided plexi K, jednostranné plexi K	85-B-19-46-01
Single sided plexi L, jednostranné plexi L	85-B-19-47-01
Single sided plexi M, jednostranné plexi M	85-B-19-48-01
Single sided plexi N, jednostranné plexi N	85-B-19-49-01
Double sided plexi O, obojstranné plexi O	85-B-19-50-01
Single sided plexi O, jednostranné plexi O	85-B-19-50-02
Double sided plexi Z1, obojstranné plexi Z1	309-B-000-00-00-27
Double sided plexi Z2, obojstranné plexi Z2	309-B-000-00-00-28



Hotel restaurant area emergency lighting application



RECESSED MOUNTING
LEDLUX-V





CEILING MOUNTING
CUBELUX

Spegel
HORTEN

24 cm, turkos

~~39:-~~ **19:-**

60 cm, turkos

~~159:-~~ **69:-**

IKEA

Handtag
BEMSTRA
120 x 60 cm

~~29:-~~
7:-

IKEA

KASSOR
VARIJIT
TRANSPORTSERVICE
Lekrum SMA
UTGANG

Handtag
ALBACK

17

~~39:-~~

395:-

~~1455:-~~
695:-

~~884:-~~
224:-

~~595:-~~
295:-

~~195:-~~





18
20



FYND
→

Vegetarisk pizzaslice
5:-

HYLLA
26, 28, 30
→

BÄTTRE
SOMN
ÅT ALLA

BÄTTRE
SOMN
ÅT ALLA

BÄTTRE
SOMN
ÅT ALLA

BÄTTRE
SOMN
ÅT ALLA



CEILING OR SUSPENDED MOUNTING CUBELUX

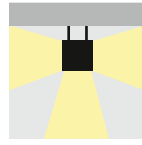

• Modern cubic shaped design suspended non-maintained (NM), maintained (M) or centralised (C) emergency lighting fixture with smooth legend illumination for all **areas such as shopping areas, airport terminals, train/bus stations, hotels, banks, entrance halls, schools, hospitals, etc.** available in all following versions:

- **AUTOTEST (-AT)**
- **CENTRAL BATTERY (C.CUBELUX) for non-addressable CBS** (look up also page No.44)
- Conforming to the requirement of EN60598-2-22, EN1838, EN62034
- Design:
 - Body made of sheet steel with PE powder painting RAL9003
 - Acrylic diffuser with a legend (must be ordered as a separate item)
- stropné alebo závesné štvorstranné núdzové svietidlo v tvare kocky s perfektnou distribúciou svetla na piktogram pre netrvalé (NM) alebo pre trvalé/netrvalé (NM/M) alebo centrálné napájané núdzové osvetlenie navrhnuté pre všeobecné použitie pre priestory ako napr. obchodné plochy, nákupné centrá, vlakové stanice, letiskové terminály, školy, nemocnice, vstupné haly a pod.
- dostupné vo verziách pre:
 - **AUTOTEST (-AT)**
 - **CENTRAL BATTERY (C.CUBELUX) pre neadresovateľné CBS** (pozri str. 44)
- spĺňa požiadavky európskej normy EN 60598-2-22, EN1838, EN62034
- konštrukcia:
 - teleso lakovaný oceľový plech v RAL9003
 - plexi kryty s piktogramom (musia sa objednať samostatne)

STANDARD FEATURES

ŠTANDARDNÁ VÝBAVA

- HighPower LEDs 120lm/W (5000K) with the lifetime >100.000h
- Ceiling mounting bracket
- LEDs indicating both presence of power supply and signaling failures
- TEST button
- výkonné LED 120lm/W (5000K) so životnosťou min 100000hod
- stropná montážna konzola
- signalizácia LED a TEST tlačítko

OPTIONAL ACCESSORIES

PRÍPLATKY

- Acrylic diffuser with the legends, 4pcs/fixture are needed (must be ordered separately - for details look up page No.201)
- Wire rope suspension set (look up page No.201)
- Wall mounting bracket (look up page No.201)
- plexi difúzor s piktogramom, 4ks/svietidlo sú potrebné (pozri str. 201 ako objednávať)
- závesný lankový set (pozri str.201)
- nástenná závesná konzola (pozri str.201)

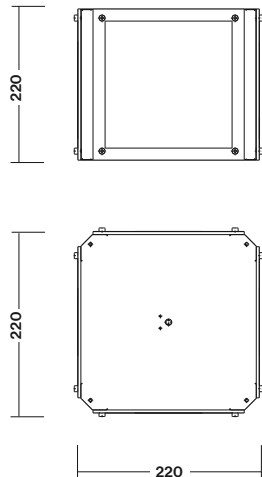
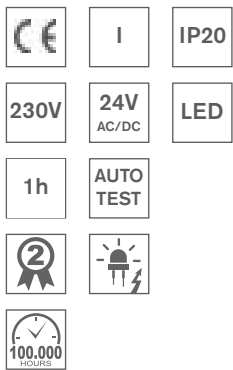

Input Power:

- 11,5W / 15,3VA (maintained M)
- 2,2W / 5,7VA (non-maintained NM)
- 8,5W / 10,9VA (CBS)



Accessory : Wire rope suspensions set
Príplatkový závesný lankový set 3m dlhý
(look up next page)

Accessory : Diffuser with Legend
Príplatkové plexi s piktogramom
(look up next page)

Page No.32

AUTOTEST -AT NM/M

Type	Version	Duration	Light Source	Light Flux / Emergency mode	Battery	Order Code	Weight
MULTICUBE-220-AT 5xLED.1h	NM/M	1h	5x HighPower LED	470 lm / 360 lm	NiMh 4,8V/4,0Ah	63-B-71-01-00	3,5 kg
MULTICUBE-220-AT 5xLED.3h	NM/M	3h	5x HighPower LED	470 lm / 360 lm	NiMh 4,8V/4,0Ah	63-B-73-01-00	3,6 kg

Page No.44

CENTRAL BATTERY (CBS)

Type	Version	Light Source	Light Flux	Order Code	Weight
C.CUBELUX-220 5xLED 24V/230V AC/DC	CBS NON-ADDRESSABLE	5x HighPower LED	470 lm	63-B-70-01-00	3,1 kg



Accessory:

- **Acrylic diffuser with the legend of type H or I or J in accordance with ISO7010 (for all TOP versions are 4pcs needed because of double sided lighting fixture)**
- **IT IS NOT INCLUDED IN STANDARD PACKAGE. IT MUST BE ORDERED AS SEPARATE ITEM !**
- Viewing Distance 41m
- **Wire rope suspension set in length 3m** (final length is set during the installation)

Príplatková výbava:

- **Príplatkové plexi s piktogramom typu H alebo I alebo J v súlade s ISO7010 (pre verzie TOP je potrebné objednať 4ks/svietidlo - obojstranné svietidlo)**
- **NIE JE SÚČASŤOU ŠTANDARDNÉHO BALENIA SVIETIDLA, MUSÍ BYŤ OBJEDNANÉ AKO SAMOSTATNÁ POLOŽKA !**
- rozoznatelnosť piktogramu 41m
- **Príplatkový závesný lankový set dĺžky 3m** (dĺžku závesu si nastavíte počas inštalácie podľa potreby)



Optional Item / Príplatok	Order Code / Objednávaci kód
Diffuser with picto "H" /plexi s piktogramom "H"	63-B-70-02-02
Diffuser with picto "I" /plexi s piktogramom "I"	63-B-70-02-04
Diffuser with picto "J" /plexi s piktogramom "J"	63-B-70-02-03
Diffuser without picto /plexi bez piktogramu "X"	63-B-70-02-05
Wire rope suspension set 3m long	63-B-35-01-00
Závesný lankový set 3m dlhý	63-B-35-01-00
Wire rope suspension set 8m long	63-B-35-06-00
Závesný lankový set 8m dlhý	63-B-35-06-00



Accessory:

- **Optional wall mounting bracket**
In this case only 3pcs of diffusers with pictograms are needed

Príplatková výbava:

- **Príplatková konzola pre montáž na kolmú stenu**
v tomto prípade sú potrebné len 3ks plexi s piktogramom

Optional Item / Príplatok	Order Code / Objednávaci kód
Upright wall mounting bracket	63-B-70-01-02
Montážna konzola na kolmú stenu	63-B-70-01-02

CEILING OR SUSPENDED MOUNTING
CUBELUX



CEILING OR SUSPENDED MOUNTING
CUBELUX



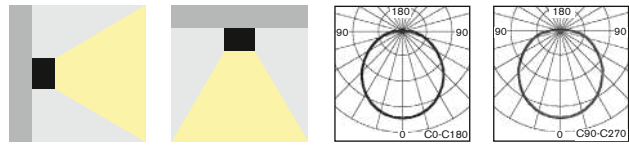

• Wall or ceiling mounted powerful fixture designed for non-maintained (NM), non-maintained/maintained (NM/M) or standard general lighting / centralised (C) emergency lighting available in all following versions:

- **AUTOTEST** (-AT)
- **CENTRAL BATTERY** (C.HILLUX) for **non-addressable CBS** (look up also page No.44)
- All C.HILLUX versions can be used also for general lighting 230V AC in order to achieve uniform design of general lighting and emergency lighting fixtures
- Conforming to the requirement of EN60598-2-22, EN1838, EN62034
- Design:
 - Body made of PC

• nástenné/stropné výkonné núdzové svietidlo určené pre netrválé (NM), trvalé/netrválé (NM/M) alebo normálne 230V / (C) centrálné napájané núdzové osvetlenie (verzie C.HILLUX môžu byť použité ako bežné svietidlá 230V AC a tým dosiahnuť kompatibilitu tvaru núdzových a všeobecných svietidiel v danom interiéru (napr každé 5 svietidlo je núdzové, ostatné ako klasické bez núdzového modulu), dostupné vo verziách pre:

- **AUTOTEST** (-AT),
- **CENTRAL BATTERY** (C.HILLUX) pre **neadresovateľné CBS** (pozri str.44)
- spĺňa požiadavky európskej normy EN 60598-2-22, EN1838, EN62034
- konštrukcia:
 - teleso z nerozbitného PC

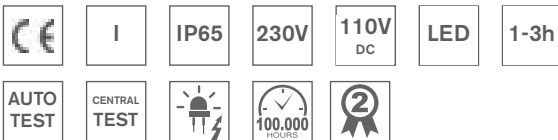

Input Power (5xLED):

- 11,5W / 15,3VA (maintained M)
- 2,2W / 5,7VA (non-maintained NM)
- 8,5W / 10,9VA (CBS)

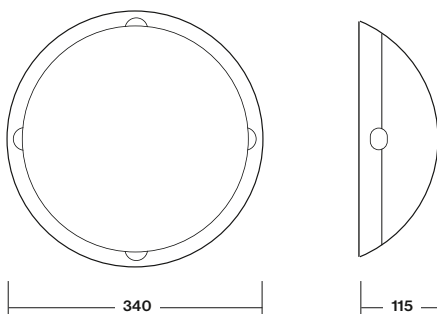

STANDARD ACCESSORIES

ŠTANDARDNÁ VÝBAVA

- **HighPower LEDs 120lm/W**, valid only for LED versions **with the lifetime >100.000h**
- Addressable **CENTRALTEST** communication module (for all ATXL and ATXP versions only)
- LEDs indicating both presence of power supply and signaling failures
- **TEST** button
- **výkonné LED 120lm/W**, len pre LED verzie **so životnosťou min 100000hod**
- adresovateľný **CENTRALTEST** komunik.modul (pre ATXP a ATXL verzie)
- signalizácia LED a **TEST** tlačítko

OPTIONS

PRÍPLATKY

- Alternative LED light colour is possible (min.order quantity 50pcs)
- alternatívna LED farba svetla podľa špecifikácie (min. 50ks)

Type	Version	Duration	Light Source	Light Flux / Emergency mode	Battery	Order Code	Weight
MULTIHILL-LED-AT.1h	NM/M	1h	5x HighPower LED 6000K	690 lm / 600 lm	NiMh 4,8V/4,0Ah	261-B-07-01	1,7 kg
MULTIHILL-LED-AT.1h	NM/M	1h	5x HighPower LED 3500K	690 lm / 600 lm	NiMh 4,8V/4,0Ah	261-B-07-03	1,7 kg
MULTIHILL-LED-AT.3h	NM/M	3h	5x HighPower LED 6000K	720 lm / 465 lm	NiMh 4,8V/4,0Ah	261-B-12-01	1,7 kg
MULTIHILL-LED-AT.3h	NM/M	3h	5x HighPower LED 3500K	720 lm / 465 lm	NiMh 4,8V/4,0Ah	261-B-14-02	1,7 kg

CENTRAL BATTERY (CBS)

Type	Version	Light Source	Light Flux	Order Code	Weight
C.HILLUX 5xLED/230V AC/DC	CBS NON-ADDRESSABLE	5x HighPower LED 6000K	675 lm	261-B-09-01	1,2 kg
C.HILLUX 5xLED/230V AC/DC	CBS NON-ADDRESSABLE	5x HighPower LED 3500K	675 lm	261-B-09-03	1,2 kg
C.HILLUX 10xLED/230V AC/DC	CBS NON-ADDRESSABLE	10x HighPower LED 6000K	1350 lm	261-B-11-01	1,2 kg
C.HILLUX 7xLED/110V DC	CBS NON-ADDRESSABLE	7x HighPower LED 3500K	945 lm	261-B-13-01	1,2 kg





OUTDOOR EMERGENCY LIGHTING EXITLUX3

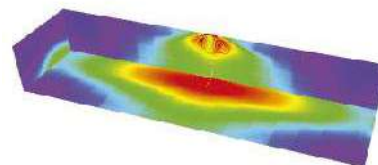

BLACK Colour Version

BROWN (dark-bronze) Colour Version

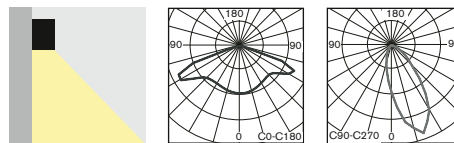
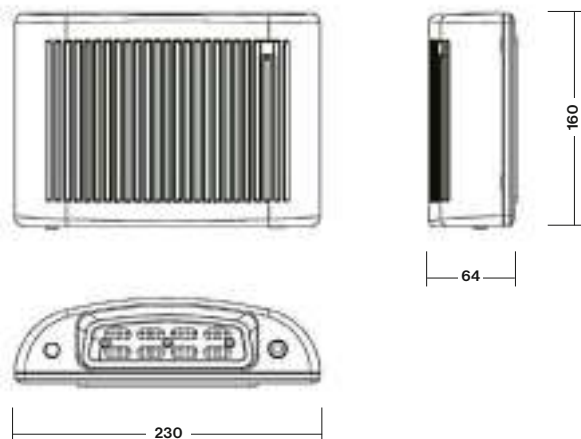
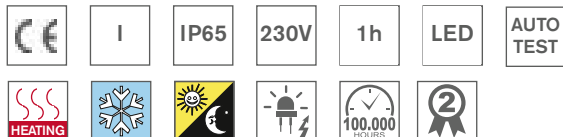

- Wall mounted powerful LED fixture designed for either corridor applications or **EXIT/ ENTRANCE areas illumination or outdoor walls**
- Equipped with **BATTERY HEATING UNIT** = suitable especially for **OUTDOOR** applications but it is possible to be installed also for interior area
- Quick connection and easy installation
- Non-maintained/maintained (NM/M) lighting with **AUTOTEST (-AT)**
- Conforming to the requirement of EN60598-2-22, EN1838, EN62034
- Design: Die casting with UV resistant powder paint in black, gray or dark bronze
- **NOVÁ generácia** nástenného výkonného LED núdzového svietidla určeného pre osvetlenie koridorov, priestoru pred vchodom/východom alebo po vonkajšom obvode budovy
- vďaka **aktívnemu riadenému vyhrievaniu batérie** pri nízkych teplotách určené hlavne pre exteriér, ale s výhodou možno použiť i v interiéri
- pre trvalé/netrvané (NM/M) núdzové osvetlenie s funkciou **AUTOTEST (-AT)**
- spĺňa požiadavky európskej normy EN 60598-2-22, EN1838, EN62034
- konštrukcia: teleso z hliníka s UV práškovou farbou v odtieni čierna, sivá alebo tmavý bronz (hnedá)

STANDARD FEATURES

STANDARDNÁ VÝBAVA

- **MidPower LEDs 150lm/W with the lifetime Min 100.000h (5000K)**
- **Heating UNIT** to protect the battery in case of low temperature below 0°C
- **Ambient light sensor** for automatic ON/OFF function for energy saving night lighting mode
- **PIR sensor**
- LEDs indicating both presence of power supply and signaling failures
- **TEST button**
- **výkonné LED 150lm/W so životnosťou min 100000hod (5000K)**
- **vybavené vyhrievacím modulom pre ochranu akumulátora pri nízkych teplotách pod 0°C**
- **vybavené senzorom okolitej hladiny osvetlenia pre automatické zapínanie/ vypínanie svietidla (nočný režim / denný režim), ktorý ale neovplyvňuje automatické zapnutie svietidla v prípade výpadku elektrickej energie**
- **pohybový PIR senzor**
- **signalizácia LED a TEST tlačítko**





Standard (default) setup of lighting fixture ON/OFF by **AMBIENT LIGHT SENSORT (ALS)**. If ambient lighting level drops down below 10lux, lighting fixture turn ON automatically. If the lighting level increases above 30lux, lighting fixture turns OFF.

Štandardné nastavenie zapínania / vypínania svietidla je nastavené cez automatický **SENZOR OKOLITÉHO OSVETLENIA (ALS)**. Ak hladina okolitého osvetlenia klesne pod 10lx, tak sa svietidlo rozsvieti, ak hladina okolitého osvetlenia vzrastie nad 30lx, tak sa svietidlo vypne.



If ambient lighting level drops down below 10lux and in addition **PIR SENSOR** detects the movement, lighting fixture turns ON and stay ON for 1min. If PIR does not detect any further movement, lighting fixture turns OFF.

Ak je hladina okolitého osvetlenia viac ako 10lx a **PIR** senzor zaznamená pohyb, svietidlo sa rozsvieti na 1min. Ak nie je zaznamenaný ďalší pohyb, tak sa svietidlo po 1min vypne.



SPECIAL DESIGN OF LENSES ensures perfect **SLIM SHAPED** lighting distribution for both corridor application or along the wall for example in front of an Entrance/Exit Outdoor application.

Špeciálne navrhnutá optika svietidla zaručuje optimálnu distribúciu svetla pre koridorové aplikácie alebo pozdĺž steny napr.nad vchodovými dverami pri exteriérovej aplikácii.

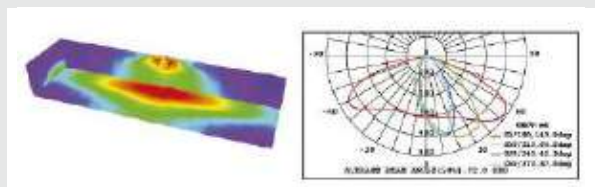



OUTDOOR EMERGENCY LIGHTING
EXITLUX3

Outdoor stairs emergency lighting application





AUTOTEST -AT NM/M

Type	Version	Colour / Farba	Light Source	Light Flux / Emergency mode	Battery	Order Code	Weight
MULTIEXIT3-AT.1h PIR+ALS+Heating	NM/M	Grey/ šedá	LED 5000K	1600 lm / 600 lm	1600 lm / 600 lm	153-B-400-01-00-01	1,5 kg
MULTIEXIT3-AT.1h PIR+ALS+Heating	NM/M	Black/ čierna	LED 5000K	1600 lm / 600 lm	1600 lm / 600 lm	153-B-400-01-00-02	1,5 kg
MULTIEXIT3-AT.1h PIR+ALS+Heating	NM/M	Bronze/ hnedá	LED 5000K	1600 lm / 600 lm	1600 lm / 600 lm	153-B-400-01-00-03	1,5 kg

PIR = Movement Detector / detektor pohybu
 ALS = Ambient Light Sensor / senzor okolitého osvetlenia
 Heating = Battery Heating Pad / vyhrievanie akumulátora

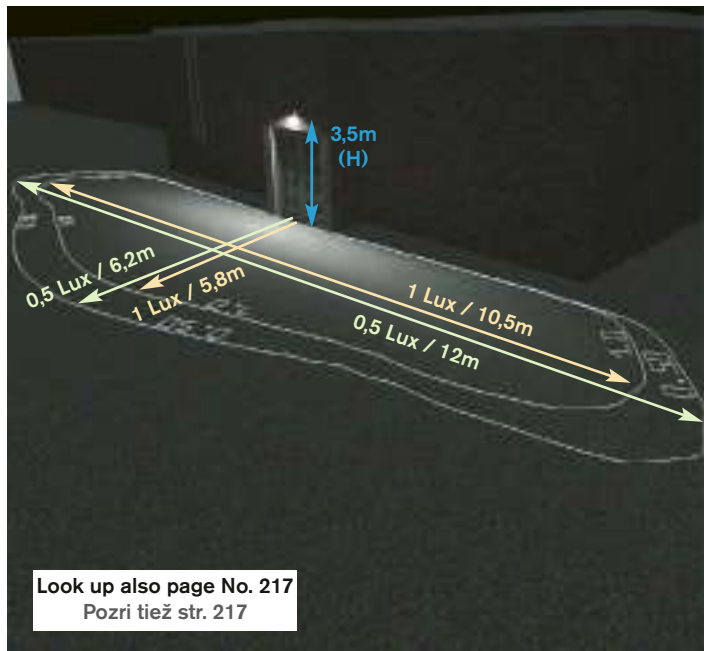
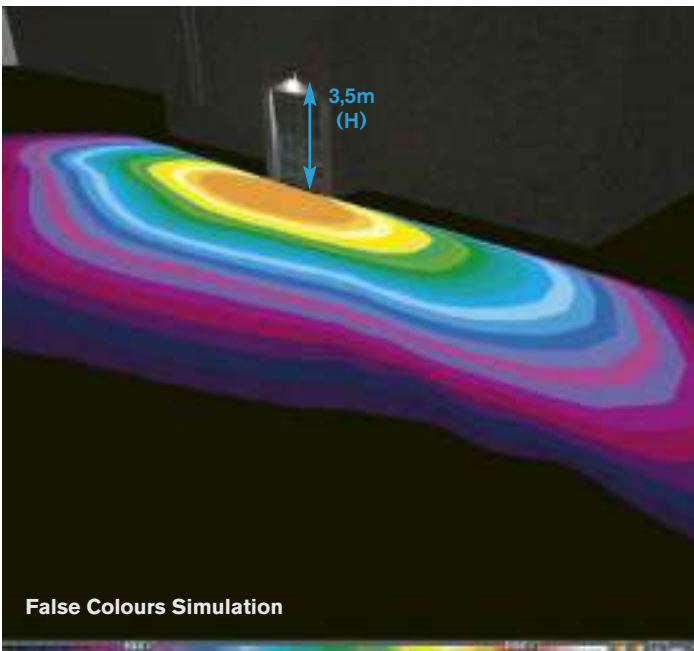

MULTIEXIT3				
H (m)	XX 0,5lx (m)	YY 0,5lx (m)	X 1,0lx (m)	Y 1,0lx (m)
2,50	5,3	9,0	4,7	8,3
2,75	5,6	10,0	5,1	9,0
3,00	5,9	10,7	5,3	9,7
3,50	6,2	12,0	5,8	10,5

1LX EMERGENCY LIGHTING LEVEL SPACING TABLES

Informatívne tabuľky rozmiestnenia núdzových svietidiel pre dosiahnutie osvetlenia 1lx

For LDT files download visit www.sec.sk LTD súbory nájdete na www.sec.sk pri každom svietidle



All values shown in spacing tables are calculated under the worst possible conditions = reflection indexes 0%, unless stated otherwise.

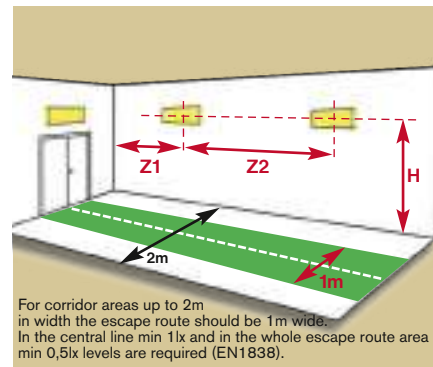
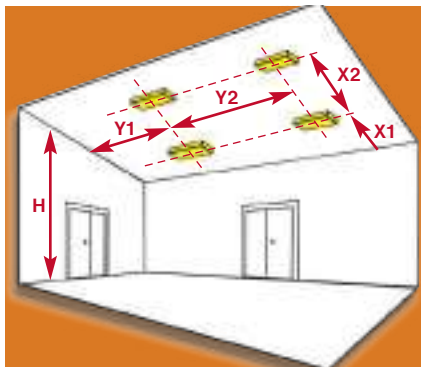

MULTITREND2-AT LED						
H (m)	X1 (m)	X2 (m)	Y1 (m)	Y2 (m)	Z1 (m)	Z2 (m)
2,75	3,4	8,8	4,5	12,0	2,9	8,8
3,00	3,5	9,1	4,6	12,3	2,7	8,6
3,50	3,5	9,6	4,5	12,4	2,4	8,2
4,00	3,6	9,9	4,4	12,6	-	-
4,50	3,5	10,1	4,2	12,7	-	-

C.TRENDLUX2 LED						
H (m)	X1 (m)	X2 (m)	Y1 (m)	Y2 (m)	Z1 (m)	Z2 (m)
2,75	4,2	10,7	5,8	15,2	2,4	6,2
3,00	4,3	11,0	5,9	15,6	2,3	6,1
3,50	4,5	11,7	6,0	16,5	2,0	5,6
4,00	4,7	12,5	6,1	17,0	1,4	4,9
4,50	4,8	13,0	6,2	17,5	0,2	3,7



MULTITREND2-AT+2xLED (without legend)						
H (m)	X1 (m)	X2 (m)	Y1 (m)	Y2 (m)	Z1 (m)	Z2 (m)
2,75	-	-	-	-	2,7	6,6
3,00	-	-	-	-	2,8	6,6
3,50	-	-	-	-	2,9	7,0
4,00	-	-	-	-	3,1	7,2
4,50	-	-	-	-	3,2	7,7

C.TRENDLUX2+2xLED (without legend)						
H (m)	X1 (m)	X2 (m)	Y1 (m)	Y2 (m)	Z1 (m)	Z2 (m)
2,75	-	-	-	-	2,2	5,3
3,00	-	-	-	-	2,5	5,8
3,50	-	-	-	-	2,7	6,3
4,00	-	-	-	-	2,8	6,7
4,50	-	-	-	-	2,9	7,2



MULTITREND2-AT+2xLED (with legend)						
H (m)	X1 (m)	X2 (m)	Y1 (m)	Y2 (m)	Z1 (m)	Z2 (m)
2,75	-	-	-	-	1,7	4,2
3,00	-	-	-	-	1,9	4,5
3,50	-	-	-	-	2,2	5,3
4,00	-	-	-	-	2,4	6,0
4,50	-	-	-	-	2,3	6,4

C.TRENDLUX2+2xLED (with legend)						
H (m)	X1 (m)	X2 (m)	Y1 (m)	Y2 (m)	Z1 (m)	Z2 (m)
2,75	-	-	-	-	1,7	4,2
3,00	-	-	-	-	1,9	4,5
3,50	-	-	-	-	2,2	5,3
4,00	-	-	-	-	2,4	6,0
4,50	-	-	-	-	2,3	6,4

For LDT files download visit www.sec.sk LTD súbory nájdete na www.sec.sk pri každom svietidle

1LX EMERGENCY LIGHTING LEVEL SPACING TABLES

Informatívne tabuľky rozmiestnenia núdzových svietidiel pre dosiahnutie osvetlenia 1lx

For LDT files download visit www.sec.sk LTD súbory nájdete na www.sec.sk pri každom svietidle



MULTIEVO2-AT
C.EVOLUX
LED

MULTIEVO2-AT LED						
H (m)	X1 (m)	X2 (m)	Y1 (m)	Y2 (m)	Z1 (m)	Z2 (m)
2,75	4,6	12,2	3,1	7,5	2,9	7,6
3,00	4,7	12,4	3,2	8,0	2,9	7,8
3,50	4,9	12,9	3,2	8,5	2,8	8,0
4,00	5,2	13,6	3,2	8,9	2,7	8,0
4,50	-	-	-	-	-	-

C.EVOLUX2 LED						
H (m)	X1 (m)	X2 (m)	Y1 (m)	Y2 (m)	Z1 (m)	Z2 (m)
2,75	5,0	13,4	3,3	8,2	3,2	8,3
3,00	5,2	13,5	3,5	8,5	3,2	8,4
3,50	5,4	14,2	3,6	9,0	3,2	8,6
4,00	5,7	14,8	3,6	9,5	3,1	8,9
4,50	-	-	-	-	-	-



MULTINORMA2-AT
C.NORMALUX
LED

MULTINORMA2-AT LED						
H (m)	X1 (m)	X2 (m)	Y1 (m)	Y2 (m)	Z1 (m)	Z2 (m)
2,75	2,8	7,5	3,1	8,4	1,9	5,7
3,00	3,0	7,7	3,2	9,1	1,9	5,7
3,50	3,1	8,2	3,4	9,1	1,1	5,0
4,00	-	-	-	-	-	-

C.NORMALUX2 LED						
H (m)	X1 (m)	X2 (m)	Y1 (m)	Y2 (m)	Z1 (m)	Z2 (m)
2,75	3,5	8,8	4,1	10,9	2,5	7,4
3,00	4,0	9,4	4,2	10,9	2,5	7,4
3,50	3,8	9,7	4,3	11,7	2,1	6,6
4,00	-	-	-	-	-	-



FALCON-AT-A
C.FALCON-A
+2xLED versions

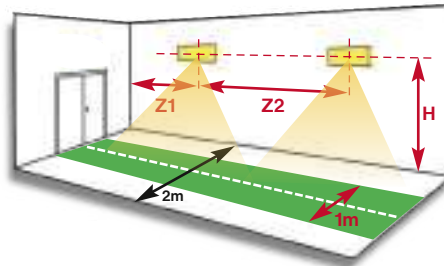

For corridor areas up to 2m in width the escape route should be 1m wide. In the central line min 1lux and in the whole escape route area min 0,5lux levels are required (EN1838).

1LX SPACING TABLE / ROZMIESTNENIE PRE 1LX		
H (m)	Z1 (m)	Z2 (m)
2,30	8	17



FALCON-AT-B
C.FALCON-B
+2xLED versions

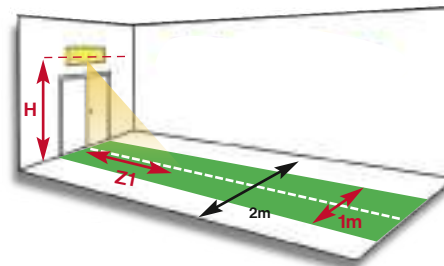

For corridor areas up to 2m in width the escape route should be 1m wide. In the central line min 1lux and in the whole escape route area min 0,5lux levels are required (EN1838).

1LX SPACING TABLE / ROZMIESTNENIE PRE 1LX	
H (m)	Z1 (m)
2,30	6

For LDT files download visit www.sec.sk LTD súbory nájdete na www.sec.sk pri každom svietidle

1LX EMERGENCY LIGHTING LEVEL SPACING TABLES

Informatívne tabuľky rozmiestnenia núdzových svietidiel pre dosiahnutie osvetlenia 1lx

For LDT files download visit www.sec.sk LTD súbory nájdete na www.sec.sk pri každom svietidle



All values shown in spacing tables are calculated under the worst possible conditions = reflection indexes 0%, unless stated otherwise.

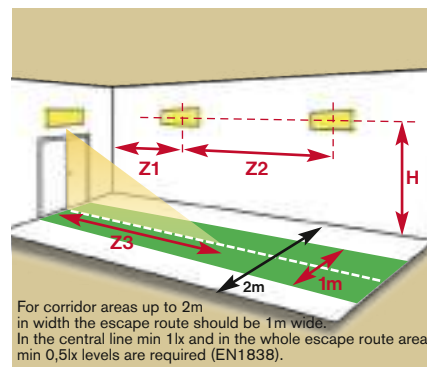
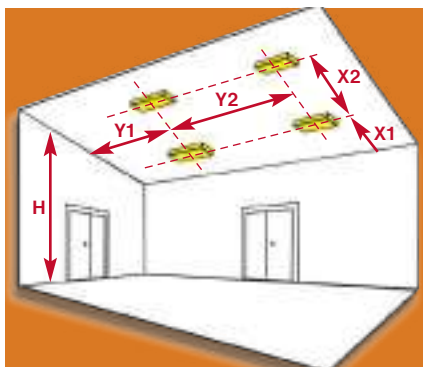

For corridor areas up to 2m in width the escape route should be 1m wide. In the central line min 1lx and in the whole escape route area min 0,5lx levels are required (EN1838).



MULTIPRIMA-AT
+2xLED
C.PRIMALUX
+2xLED

MULTIPRIMA-A-AT +2xLED				
H (m)	Z1 (m)	Z2 (m)	Z3/0,5lx (m)	Z3/1lx (m)
2,00	2,2	5,7	4,9	4,0
2,10	2,2	5,7	5,0	4,1
2,30	2,1	5,7	5,2	4,3
2,50	2,0	5,7	5,4	4,3
2,75	1,7	5,7	5,6	4,4
3,00	-	5,7	5,8	4,4

C.PRIMALUX-A+2xLED				
H (m)	Z1 (m)	Z2 (m)	Z3/0,5lx (m)	Z3/1lx (m)
2,00	2,2	5,7	4,9	4,0
2,10	2,2	5,7	5,0	4,1
2,30	2,1	5,7	5,2	4,3
2,50	2,0	5,7	5,4	4,3
2,75	1,7	5,7	5,6	4,4
3,00	-	5,7	5,8	4,4



For LDT files download visit www.sec.sk
LTD súbory nájdete na www.sec.sk pri každom svietidle



MULTIPRIMA-APA
MULTIPRIMA-APA
MULTIPRIMA-APB
MULTIPRIMA-APB
+2xLED

C.PRIMALUX-APA
C.PRIMALUX-AVA
C.PRIMALUX-APB
C.PRIMALUX-AVB
+2xLED

MULTIPRIMA-AT-APA/-AVA +2xLED						
H (m)	X1 (m)	X2 (m)	Y1 (m)	Y2 (m)	Z1 (m)	Z2 (m)
2,75	-	-	6,0	17,5	-	-
3,00	-	-	6,1	17,9	-	-
3,50	-	-	5,7	18,0	-	-
4,00	-	-	4,7	17,5	-	-

C.PRIMALUX-APA/-AVA +2xLED						
H (m)	X1 (m)	X2 (m)	Y1 (m)	Y2 (m)	Z1 (m)	Z2 (m)
2,75	-	-	6,0	17,5	-	-
3,00	-	-	6,1	17,9	-	-
3,50	-	-	5,7	18,0	-	-
4,00	-	-	4,7	17,5	-	-



MULTIPRIMA-AT-APB/-AVB +2xLED						
H (m)	X1 (m)	X2 (m)	Y1 (m)	Y2 (m)	Z1 (m)	Z2 (m)
2,75	4,0	10,5	3,0	9,6	-	-
3,00	3,1	11,2	2,3	9,8	-	-
3,50	-	-	-	-	-	-
4,00	-	-	-	-	-	-

C.PRIMALUX-APB/-AVB +2xLED						
H (m)	X1 (m)	X2 (m)	Y1 (m)	Y2 (m)	Z1 (m)	Z2 (m)
2,75	4,0	10,5	3,0	9,6	-	-
3,00	3,1	11,2	2,3	9,8	-	-
3,50	-	-	-	-	-	-
4,00	-	-	-	-	-	-

For LDT files download visit www.sec.sk LTD súbory nájdete na www.sec.sk pri každom svietidle

1LX EMERGENCY LIGHTING LEVEL SPACING TABLES

Informatívne tabuľky rozmiestnenia núdzových svietidiel pre dosiahnutie osvetlenia 1lx

For LDT files download visit www.sec.sk LTD súbory nájdete na www.sec.sk pri každom svietidle



MULTILED-SPOT2-A
C.LEDLUX-SPOT2-A

Centre line of the escape route (according to EN1838): Emin=1,02lx (min required 1lx), Emin/Emax= 1:6,43 (required max 1:40) *



MULTILED-SPOT2-A
C.LEDLUX-SPOT2-A

C.LEDLUX-SPOT2-A / MULTILED-SPOT2-A						
H (m)	X1 (m)	X2 (m)	Y1 (m)	Y2 (m)	Z1 (m)	Z2 (m)
2,75	-	-	8,3	20,1	-	-
3,00	-	-	8,4	20,9	-	-
3,50	-	-	7,9	22,5	-	-
4,00	-	-	7,7	23,5	-	-
4,50	-	-	7,1	23,1	-	-
5,00	-	-	6,4	21,9	-	-



MULTILED-SPOT2-B
C.LEDLUX-SPOT2-B

Centre line of the escape route (according to EN1838): Emin=1,01lx (min required 1lx), Emin/Emax= 1:7,02 (required max 1:40) *



MULTILED-SPOT2-B
C.LEDLUX-SPOT2-B

C.LEDLUX-SPOT2-B / MULTILED-SPOT2-B						
H (m)	X1 (m)	X2 (m)	Y1 (m)	Y2 (m)	Z1 (m)	Z2 (m)
2,75	3,8	12,6	3,8	12,6	-	-
3,00	3,3	12,7	3,3	12,7	-	-
3,50	2,5	11,8	2,5	11,8	-	-
4,00	1,8	10,1	1,8	10,1	-	-



FOR HIGH CEILING >4m PRE VYSOKÉ STROPY >4m



MULTILED-SPOT2-HCA 2xLED
C.LEDLUX-SPOT2-HCA 2xLED

Centre line of the escape route (according to EN1838): Emin=1,02lx (min required 1lx), Emin/Emax= 1:11 (required max 1:40) *

C.LEDLUX-SPOT2/ MULTILED-SPOT2 HCA						
H (m)	X1 (m)	X2 (m)	Y1 (m)	Y2 (m)	Z1 (m)	Z2 (m)
4,00	-	-	8,0	18,9	-	-
5,00	-	-	8,9	21,4	-	-
6,00	-	-	9,7	23,5	-	-
7,00	-	-	10,3	25,4	-	-
8,00	-	-	10,8	26,9	-	-
9,00	-	-	11,2	28,3	-	-



MULTILED-SPOT2-HCB 2xLED
C.LEDLUX-SPOT2-HCB 2xLED

Centre line of the escape route (according to EN1838): Emin=1,02lx (min required 1lx), Emin/Emax= 1:11 (required max 1:40) *

C.LEDLUX-SPOT2/ MULTILED-SPOT2 HCB						
H (m)	X1 (m)	X2 (m)	Y1 (m)	Y2 (m)	Z1 (m)	Z2 (m)
4,00	6,0	13,9	6,0	13,9	-	-
5,00	6,5	15,9	6,5	15,9	-	-
6,00	6,7	17,5	6,7	17,5	-	-
7,00	6,4	18,5	6,4	18,5	-	-
7,50	4,5	18,7	4,5	18,7	-	-
8,00	2,7	18,8	2,7	18,8	-	-

For LDT files download visit www.sec.sk LTD súbory nájdete na www.sec.sk pri každom svietidle

1LX EMERGENCY LIGHTING LEVEL SPACING TABLES

Informatívne tabuľky rozmiestnenia núdzových svietidiel pre dosiahnutie osvetlenia 1lx

For LDT files download visit www.sec.sk LTD súbory nájdete na www.sec.sk pri každom svietidle



All values shown in spacing tables are calculated under the worst possible conditions = reflection indexes 0%, unless stated otherwise.

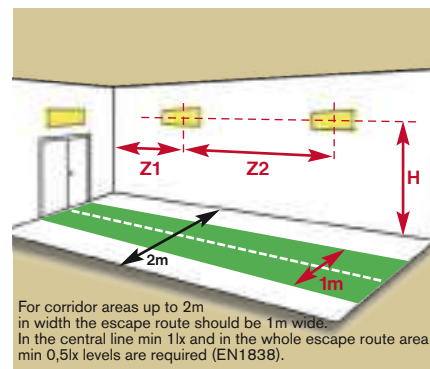
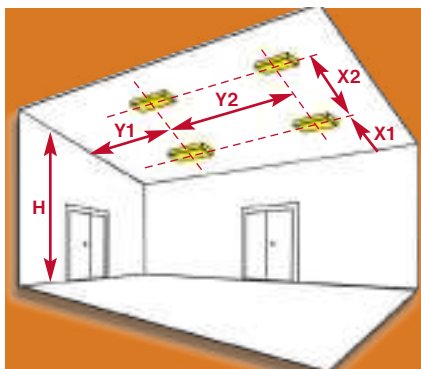

For corridor areas up to 2m in width the escape route should be 1m wide. In the central line min 1lx and in the whole escape route area min 0,5lx levels are required (EN1838).



MULTIARRIS2-AT-A
C.ARRISLUX2-A
+1xLED

MULTIARRIS-AT-A+1xLED						
H (m)	X1 (m)	X2 (m)	Y1 (m)	Y2 (m)	Z1 (m)	Z2 (m)
2,30	-	-	-	-	10	20
2,75	-	-	-	-	8	16
-	-	-	-	-	-	-
-	-	-	-	-	-	-



MULTIARRIS2-AT-B
C.ARRISLUX2-B
+1xLED

C.ARRISLUX-A+1xLED						
H (m)	X1 (m)	X2 (m)	Y1 (m)	Y2 (m)	Z1 (m)	Z2 (m)
2,75	-	-	-	-	10	20
3,00	-	-	-	-	8	16
3,50	-	-	-	-	-	-
4,00	-	-	-	-	-	-



MULTITRIPLE2-AT-B
C.TRIPLELUX2-B
+1xLED



MULTITRIPLE2-AT-A
C.TRIPLELUX2-A
+1xLED

MULTITRIPLE-AT-A+1xLED						
H (m)	X1 (m)	X2 (m)	Y1 (m)	Y2 (m)	Z1 (m)	Z2 (m)
2,30	-	-	-	-	10	20
2,75	-	-	-	-	8	16
-	-	-	-	-	-	-
-	-	-	-	-	-	-

C.TRIPLELUX-A+1xLED						
H (m)	X1 (m)	X2 (m)	Y1 (m)	Y2 (m)	Z1 (m)	Z2 (m)
2,75	-	-	-	-	10	20
3,00	-	-	-	-	8	16
3,50	-	-	-	-	-	-
4,00	-	-	-	-	-	-



For LDT files download visit www.sec.sk LTD súbory nájdete na www.sec.sk pri každom svietidle

1LX EMERGENCY LIGHTING LEVEL SPACING TABLES

Informatívne tabuľky rozmiestnenia núdzových svietidiel pre dosiahnutie osvetlenia 1lx

For LDT files download visit www.sec.sk LTD súbory nájdete na www.sec.sk pri každom svietidle



FALCON-P-AT
FALCON-V-AT
C.FALCON-P
C.FALCON-V

FALCON-AT						
H (m)	X1 (m)	X2 (m)	Y1 (m)	Y2 (m)	Z1 (m)	Z2 (m)
2,50	2,1	5,7	2,1	5,7	-	-
3,00	2,2	6,2	2,2	6,2	-	-
4,00	-	-	-	-	-	-
4,50	-	-	-	-	-	-

C.FALCON						
H (m)	X1 (m)	X2 (m)	Y1 (m)	Y2 (m)	Z1 (m)	Z2 (m)
2,50	2,7	7,2	2,7	7,2	-	-
3,00	2,8	7,5	2,8	7,5	-	-
4,00	-	-	-	-	-	-
4,50	-	-	-	-	-	-



Multipictor-AT 8W
Multipictor-5xLED
Multipictor-3xLED
MULTIPICTOR 8W
PICTORLUX 8W
C.PICTORLUX 8W
C.Pictorlux-5xLED
C.Pictorlux-3xLED

MULTIPICTOR-AT 8W						
H (m)	X1 (m)	X2 (m)	Y1 (m)	Y2 (m)	Z1 (m)	Z2 (m)
2,75	3,2	8,6	2,8	7,3	2,2	6,6
3,00	3,2	8,8	2,9	7,5	1,9	6,4
3,50	3,1	9,0	2,8	7,8	1,4	6,0
4,00	3,0	9,1	2,7	8,0	-	-

PICTORLUX / MULTIPICTOR 8W						
H (m)	X1 (m)	X2 (m)	Y1 (m)	Y2 (m)	Z1 (m)	Z2 (m)
2,75	2,5	7,2	2,3	6,3	1,5	5,2
3,00	2,5	7,2	2,2	6,3	-	-
3,50	2,2	7,2	2,2	6,3	-	-
4,00	1,8	7,0	1,6	6,1	-	-

MULTIPICTOR-5xLED						
H (m)	X1 (m)	X2 (m)	Y1 (m)	Y2 (m)	Z1 (m)	Z2 (m)
2,75	3,8	11,5	4,3	11,1	3,6	9,2
3,00	3,8	10,6	4,4	11,4	3,5	8,7
3,50	3,9	10,3	4,4	11,8	3,1	8,4
4,00	3,9	10,6	4,3	12,3	2,5	7,4

C.PICTORLUX 8W						
H (m)	X1 (m)	X2 (m)	Y1 (m)	Y2 (m)	Z1 (m)	Z2 (m)
2,75	4,3	11,5	3,6	8,9	3,3	8,3
3,00	4,4	11,8	3,8	9,3	3,2	8,4
3,50	4,5	12,1	3,9	9,9	3,0	8,7
4,00	4,5	12,3	4,0	10,4	2,8	8,8

C.PICTORLUX-5xLED						
H (m)	X1 (m)	X2 (m)	Y1 (m)	Y2 (m)	Z1 (m)	Z2 (m)
2,75	4,1	14,3	4,7	11,9	3,7	9,8
3,00	4,2	13,2	4,8	12,3	3,8	9,4
3,50	4,3	11,6	4,9	12,9	3,5	9,0
4,00	4,4	11,6	4,8	13,4	3,1	8,7



MULTHILL 5xLED
HILLUX 18W
C.HILLUX 5xLED
C.HILLUX 18W

MULTHILL 5xLED						
H (m)	X1 (m)	X2 (m)	Y1 (m)	Y2 (m)	Z1 (m)	Z2 (m)
2,75	4,0	10,4	4,0	10,4	3,2	8,4
3,00	4,0	10,6	4,0	10,6	2,8	8,1
3,50	4,1	11,0	4,1	11,0	2,4	7,7
4,00	4,0	11,2	4,0	11,2	1,7	7,0

HILLUX 18W						
H (m)	X1 (m)	X2 (m)	Y1 (m)	Y2 (m)	Z1 (m)	Z2 (m)
2,75	2,8	7,7	2,8	7,7	1,4	5,6
3,00	2,9	7,9	2,9	7,9	-	-
3,50	2,8	8,0	2,8	8,0	-	-
4,00	2,7	8,1	2,7	8,1	-	-

C.HILLUX 5xLED						
H (m)	X1 (m)	X2 (m)	Y1 (m)	Y2 (m)	Z1 (m)	Z2 (m)
2,75	4,4	11,4	4,4	11,4	3,5	9,2
3,00	4,4	11,6	4,4	11,6	3,3	8,8
3,50	4,5	12,0	4,5	12,0	2,9	8,4
4,00	4,5	12,4	4,5	12,4	2,3	8,0

C.HILLUX 18W						
H (m)	X1 (m)	X2 (m)	Y1 (m)	Y2 (m)	Z1 (m)	Z2 (m)
2,75	5,4	13,4	5,4	13,4	2,6	7,5
3,00	5,6	14,0	5,6	14,0	2,0	7,0
3,50	5,9	14,7	5,9	14,7	-	-
4,00	6,1	15,6	6,1	15,6	-	-

For LDT files download visit www.sec.sk LTD súbory nájdete na www.sec.sk pri každom svietidle

1LX EMERGENCY LIGHTING LEVEL SPACING TABLES

Informatívne tabuľky rozmiestnenia núdzových svietidiel pre dosiahnutie osvetlenia 1lx

For LDT files download visit www.sec.sk LTD súbory nájdete na www.sec.sk pri každom svietidle



All values shown in spacing tables are calculated under the worst possible conditions = reflection indexes 0%, unless stated otherwise.

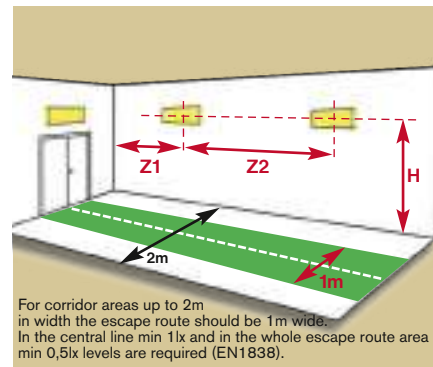
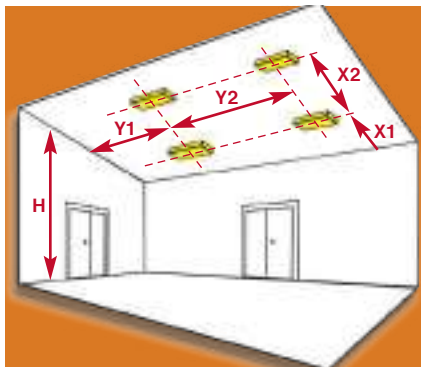

For corridor areas up to 2m in width the escape route should be 1m wide. In the central line min 1lx and in the whole escape route area min 0,5lx levels are required (EN1838).



MULTIPOWER2-AT
C.POWERLUX2

FOR HIGH CEILING >4m
PRE VYSOKÉ STROPY >4m

MULTIPOWER2-AT LED						
H (m)	X1 (m)	X2 (m)	Y1 (m)	Y2 (m)	Z1 (m)	Z2 (m)
4,00	7,9	17,3	7,9	17,3	-	-
5,00	8,4	19,9	8,4	19,9	-	-
6,00	9,1	22,1	9,1	22,1	-	-
7,00	9,7	24,0	9,7	24,0	-	-
8,00	10,0	25,2	10,0	25,2	-	-
9,00	10,2	26,5	10,2	26,5	-	-
10,0	10,3	27,6	10,3	27,6	-	-
11,0	10,5	28,4	10,5	28,4	-	-
12,0	10,6	28,7	10,6	28,7	-	-
13,0	10,4	29,2	10,4	29,2	-	-
14,0	10,2	29,4	10,2	29,4	-	-
15,0	9,7	29,5	9,7	29,5	-	-
16,0	9,3	29,8	9,3	29,8	-	-
17,0	8,6	30,0	8,6	30,0	-	-
18,0	7,7	29,8	7,7	29,8	-	-
19,0	7,1	29,3	7,1	29,3	-	-
20,0	5,9	28,6	5,9	28,6	-	-

C.POWERLUX2-LED						
H (m)	X1 (m)	X2 (m)	Y1 (m)	Y2 (m)	Z1 (m)	Z2 (m)
4,00	9,0	20,0	9,0	20,0	-	-
5,00	10,5	23,2	10,5	23,2	-	-
6,00	11,8	26,3	11,8	26,3	-	-
7,00	13,0	28,9	13,0	28,9	-	-
8,00	14,0	31,6	14,0	31,6	-	-
9,00	14,7	34,0	14,7	34,0	-	-
10,0	15,5	35,8	15,5	35,8	-	-
11,0	15,8	37,7	15,8	37,7	-	-
12,0	16,3	39,3	16,3	39,3	-	-
13,0	16,7	40,5	16,7	40,5	-	-
14,0	16,8	41,3	16,8	41,3	-	-
15,0	17,0	42,0	17,0	42,0	-	-
16,0	17,3	42,8	17,3	42,8	-	-
17,0	17,3	43,4	17,3	43,4	-	-
18,0	17,3	43,7	17,3	43,7	-	-
19,0	17,3	44,3	17,3	44,3	-	-
20,0	17,0	44,5	17,0	44,5	-	-



MULTIROTALUX2-AT
LED
C.ROTALUX2-LED

FOR HIGH CEILING >4m
PRE VYSOKÉ STROPY >4m

MULTIROTALUX2-AT LED						
H (m)	X1 (m)	X2 (m)	Y1 (m)	Y2 (m)	Z1 (m)	Z2 (m)
4,00	7,9	17,3	7,9	17,3	-	-
5,00	8,4	19,9	8,4	19,9	-	-
6,00	9,1	22,1	9,1	22,1	-	-
7,00	9,7	24,0	9,7	24,0	-	-
8,00	10,0	25,2	10,0	25,2	-	-
9,00	10,2	26,5	10,2	26,5	-	-
10,0	10,3	27,6	10,3	27,6	-	-
11,0	10,5	28,4	10,5	28,4	-	-
12,0	10,6	28,7	10,6	28,7	-	-
13,0	10,4	29,2	10,4	29,2	-	-
14,0	10,2	29,4	10,2	29,4	-	-
15,0	9,7	29,5	9,7	29,5	-	-
16,0	9,3	29,8	9,3	29,8	-	-
17,0	8,6	30,0	8,6	30,0	-	-
18,0	7,7	29,8	7,7	29,8	-	-
19,0	7,1	29,3	7,1	29,3	-	-
20,0	5,9	28,6	5,9	28,6	-	-

C.ROTALUX2 LED						
H (m)	X1 (m)	X2 (m)	Y1 (m)	Y2 (m)	Z1 (m)	Z2 (m)
4,00	9,0	20,0	9,0	20,0	-	-
5,00	10,5	23,2	10,5	23,2	-	-
6,00	11,8	26,3	11,8	26,3	-	-
7,00	13,0	28,9	13,0	28,9	-	-
8,00	14,0	31,6	14,0	31,6	-	-
9,00	14,7	34,0	14,7	34,0	-	-
10,0	15,5	35,8	15,5	35,8	-	-
11,0	15,8	37,7	15,8	37,7	-	-
12,0	16,3	39,3	16,3	39,3	-	-
13,0	16,7	40,5	16,7	40,5	-	-
14,0	16,8	41,3	16,8	41,3	-	-
15,0	17,0	42,0	17,0	42,0	-	-
16,0	17,3	42,8	17,3	42,8	-	-
17,0	17,3	43,4	17,3	43,4	-	-
18,0	17,3	43,7	17,3	43,7	-	-
19,0	17,3	44,3	17,3	44,3	-	-
20,0	17,0	44,5	17,0	44,5	-	-

For LDT files download visit www.sec.sk LTD súbory nájdete na www.sec.sk pri každom svietidle

1LX EMERGENCY LIGHTING LEVEL SPACING TABLES

Informatívne tabuľky rozmiestnenia núdzových svietidiel pre dosiahnutie osvetlenia 1lx

For LDT files download visit www.sec.sk LTD súbory nájdete na www.sec.sk pri každom svietidle

PERUN2-AT						
H (m)	X1 (m)	X2 (m)	Y1 (m)	Y2 (m)	Z1 (m)	Z2 (m)
4,00	8,0	18,6	7,8	18,5	-	-
5,00	8,7	20,5	8,6	20,1	-	-
6,00	9,3	22,4	9,2	21,7	-	-
7,00	10,2	22,8	9,8	23,3	-	-
8,00	10,4	24,0	9,9	23,8	-	-
9,00	10,9	25,7	10,2	24,8	-	-
10,0	11,2	26,0	10,5	25,6	-	-
11,0	11,4	26,7	10,7	26,2	-	-
12,0	11,4	27,5	10,8	27,5	-	-
13,0	11,8	29,0	10,9	28,0	-	-
14,0	10,4	29,2	10,5	27,7	-	-
15,0	10,0	27,6	10,2	27,2	-	-
16,0	9,6	27,4	10,0	26,8	-	-
17,0	9,1	25,8	9,6	27,5	-	-
18,0	9,2	26,4	8,5	27,6	-	-
19,0	9,0	27,1	8,2	27,5	-	-
20,0	7,9	27,0	7,3	27,2	-	-

C.PERUN2						
H (m)	X1 (m)	X2 (m)	Y1 (m)	Y2 (m)	Z1 (m)	Z2 (m)
4,00	10,1	22,5	9,7	22,0	-	-
5,00	11,0	25,7	10,6	24,7	-	-
6,00	12,1	27,4	11,7	26,7	-	-
7,00	12,5	30,0	12,5	28,7	-	-
8,00	12,7	31,5	13,4	30,7	-	-
9,00	13,7	33,5	13,8	32,5	-	-
10,0	14,3	33,7	14,1	34,0	-	-
11,0	14,8	34,6	14,6	35,0	-	-
12,0	15,7	35,3	14,8	35,3	-	-
13,0	16,4	37,3	15,3	36,6	-	-
14,0	16,5	37,6	15,6	36,7	-	-
15,0	17,0	39,3	15,7	37,8	-	-
16,0	17,5	39,6	15,9	40,6	-	-
17,0	16,8	40,6	15,9	41,1	-	-
18,0	15,7	41,7	16,0	41,3	-	-
19,0	16,4	42,4	16,0	41,5	-	-
20,0	15,5	43,8	16,0	41,8	-	-



PERUN2-AT
C.PERUN2

FOR HIGH CEILING >4m
PRE VYSOKÉ STROPY >4m

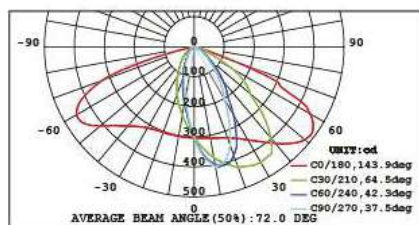

MULTIEXIT3				
H (m)	XX 0,5lx (m)	YY 0,5lx (m)	X 1,0lx (m)	Y 1,0lx (m)
2,50	5,3	9,0	4,7	8,3
2,75	5,6	10,0	5,1	9,0
3,00	5,9	10,7	5,3	9,7
3,50	6,2	12,0	5,8	10,5



MULTIEXIT3-LED

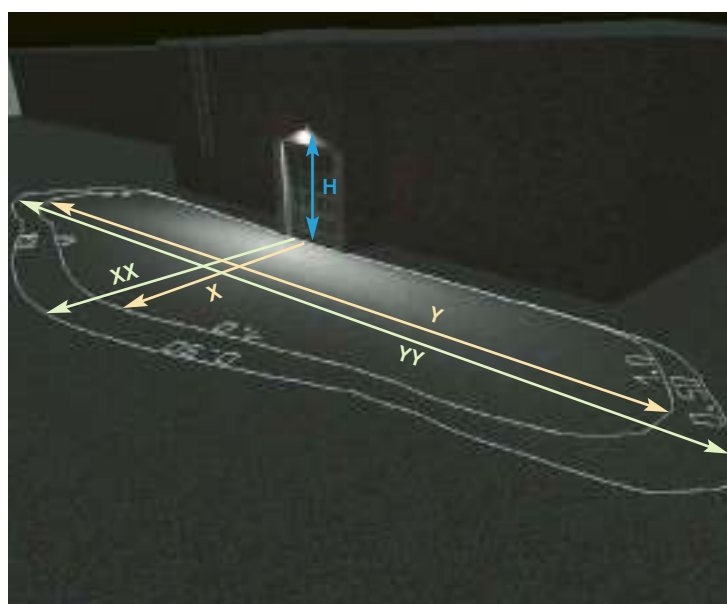
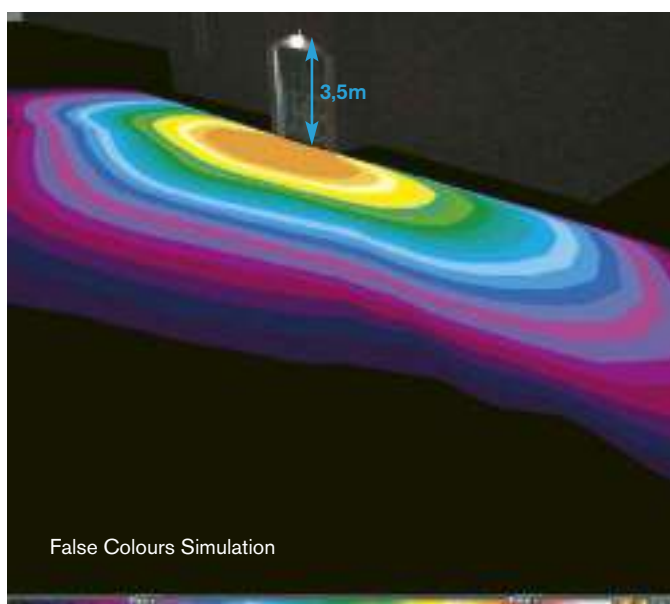

For LDT files download visit www.sec.sk LTD súbory nájdete na www.sec.sk pri každom svietidle



EST.1992



SEC Video Presentation



PROFESSIONAL LIGHTING SOLUTIONS

2020/2021

SEC s.r.o.

Jakuba Haška 11
949 01 Nitra
Slovakia

Sales Dept./ Odd.predaja:

tel: +421-37-656 08 25
tel: +421-37-656 08 03

sales1@sec.sk
sales4@sec.sk

Head Office / Vedenie:

tel: +421-37-656 08 02
office@sec.sk

Project Dept. / Projektové odd.:

tel: +421-37-656 08 18
sec@sec.sk

Quality Dept. / Odd. kvality:

tel: +421-37-656 08 07
quality@sec.sk

www.sec.sk

All rights reserved (C) SEC. Specifications are subject to change without notice.